



**CONTRACT DOCUMENTS
AND
SPECIFICATIONS**

DIVISION OF TRAFFIC ENGINEERING

FOR

**Winchester Road, East Seventh Street, Liberty
Road Intersection Improvements**

Bid 15-2018

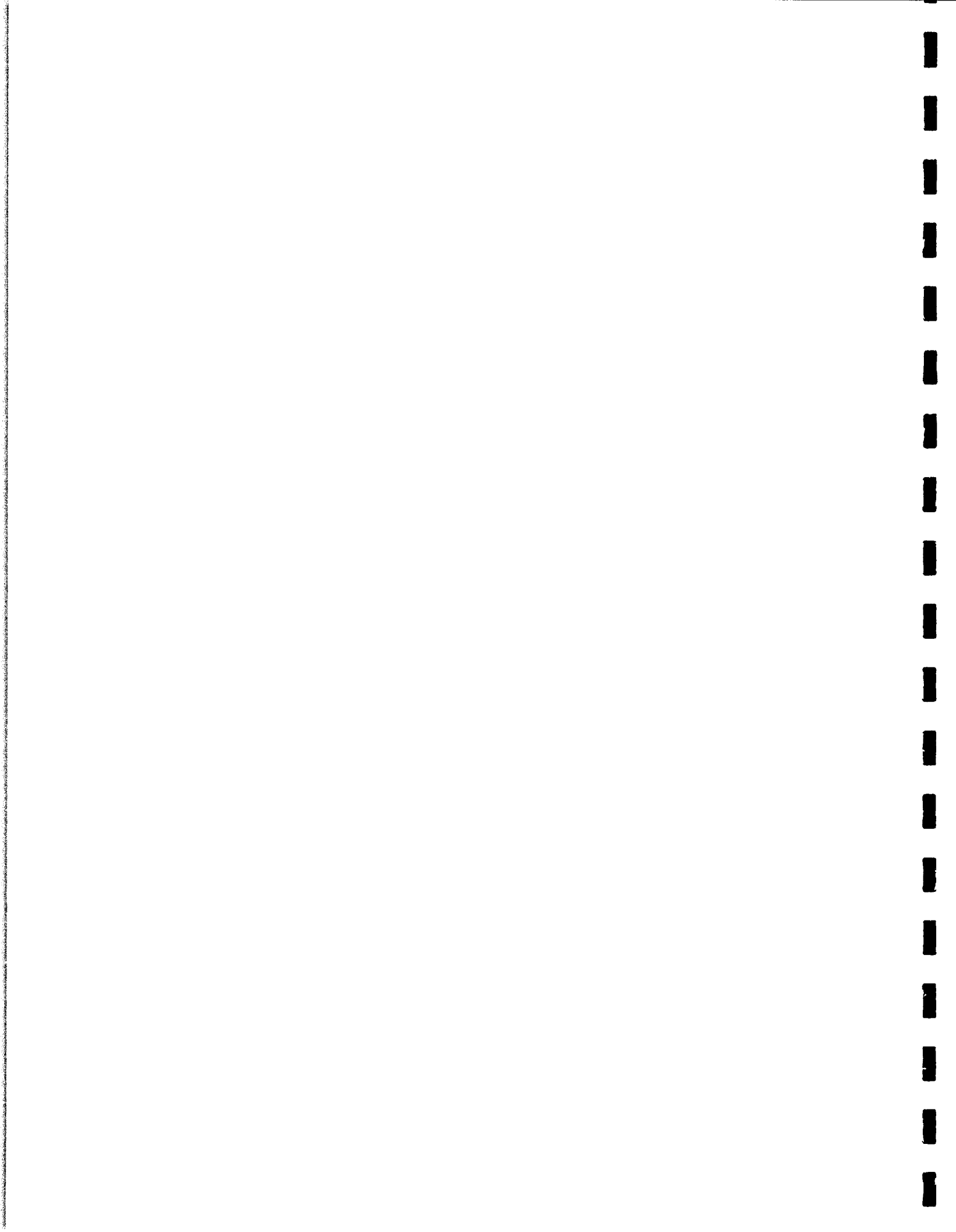
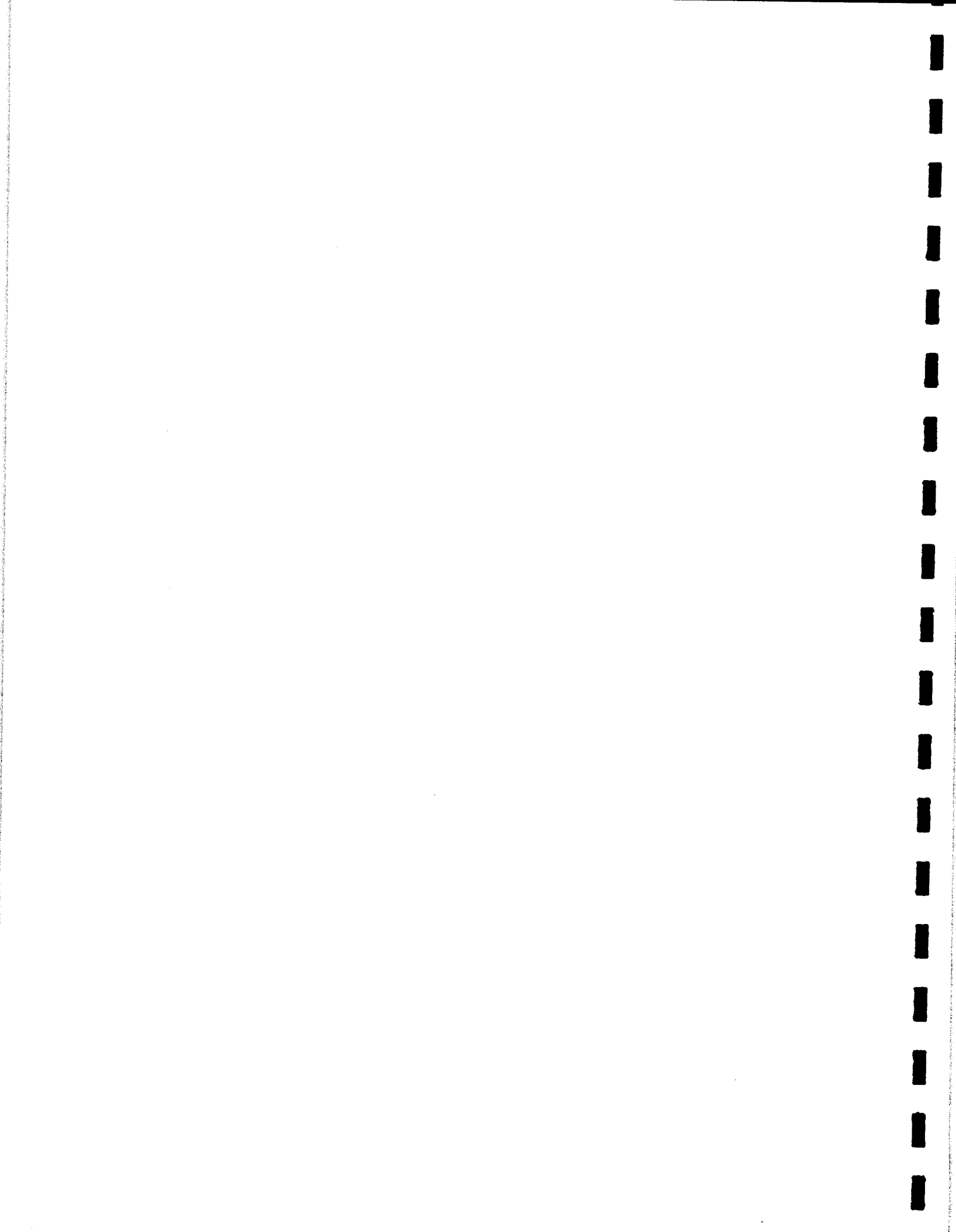

TABLE OF CONTENTS
CONTRACT DOCUMENTS

PART I	ADVERTISEMENT FOR BIDS
PART II	INFORMATION FOR BIDDERS
PART III	FORM OF PROPOSAL
PART IV	GENERAL CONDITIONS
PART V	SPECIAL CONDITIONS
PART VI	CONTRACT AGREEMENT
PART VII	PERFORMANCE AND PAYMENT BONDS
PART VIII	TECHNICAL SPECIFICATIONS
PART IX	ADDENDA
APPENDIX A	STANDARD DRAWINGS
APPENDIX B	KYTC APPROVED TRAFFIC MANAGEMENT PLAN
APPENDIX C	LPA Documents
	MAST ARM DESIGN ANALYSIS



PART 1
ADVERTISEMENT FOR BIDS

INDEX

1. INVITATION
2. DESCRIPTION OF WORK
3. OBTAINING PLANS, SPECIFICATIONS, AND BID DOCUMENTS
4. METHOD OF RECEIVING BIDS
5. METHOD OF AWARD
6. BID WITHDRAWAL
7. BID SECURITY
8. SUBMISSION OF BIDS
9. RIGHT TO REJECT
10. NOTIFICATION TO THE LFUCG FOR AFFIRMATIVE ACTION
11. NOTICE CONCERNING DBE GOAL - LFUCG
12. NOTICE CONCERNING DBE GOAL - KYTC
13. PRE-BID MEETING
14. EXCLUDED PARTIES LIST SYSTEM (EPLS)

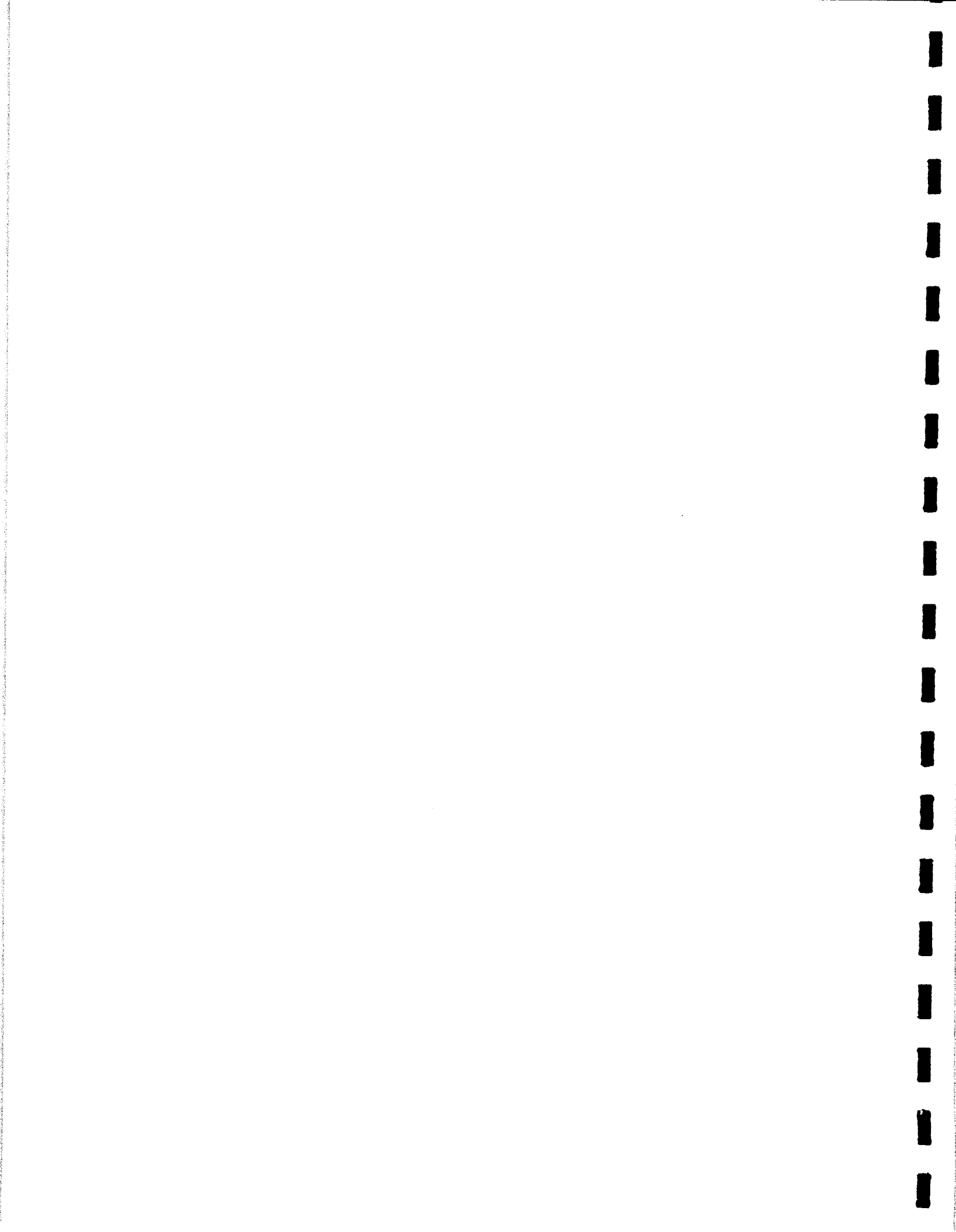

ADVERTISEMENT FOR BIDS

1. INVITATION

Sealed proposals for the following work will be received by the Lexington-Fayette Urban County Government (LFUCG) until 2:00 p.m., local time, **February 27, 2018**, for furnishing all labor and/or materials and performing all work as set forth by this advertisement, conditions (general and special), specifications, and/or the drawings prepared by and for Lexington-Fayette Urban County Government, Division of Traffic Engineering. Immediately following the scheduled closing time for reception of bids, all proposals which have been submitted in accordance with the above will be publicly opened and read aloud.

This project is a Federal Project subject to the requirements of the Federal-aid Highway Program. The KYTC Item Number for this bid is [07-03204]. The federal project number for this bid is [STPE 4003-004], and the Contract ID is [PO2-628-1600003038]. Federal Form FHWA-1273 is attached hereto and fully incorporated herein by reference.

Except as otherwise indicated on the Plans, and in the Contract Documents and Specifications, all items of Work including materials, construction methods, method of measurement and basis of payment shall comply with the current edition of the *Kentucky Department of Highways (KDOH) Standard Specifications for Road and Bridge Construction, 2012 Edition* and all current revisions.

2. DESCRIPTION OF WORK

Consisting of the construction and/or furnishing of items as listed in the Bid Schedule included in Part III, Form of Proposal, of this document, plus incidentals necessary to complete the work. The work entails removal of the existing traffic signals, poles, and pavement, construction of mast arms for two signalized intersections and approximately 450 square yards of concrete sidewalk, entrance pavement, and curb ramps along US 60 (Winchester Road).

Bids will only be accepted from plan holders who have purchased plans from Lynn Imaging and are subsequently registered as "official plan holders." Bidders and DBE subcontractors must be prequalified with the Kentucky Transportation Cabinet and possess a Certificate of Eligibility at the time of the bid opening. All other subcontractors must be prequalified when accepting subcontracts.

3. OBTAINING PLANS, SPECIFICATIONS, AND BID DOCUMENTS

Plans, Specifications, and Contract Documents may be obtained from the official bid document distributor, LYNN IMAGING, 328 Old Vine Street, Lexington, KY 40507, (859) 255-1021 or (www.lynnimaging.com) and click on plan room for a non-refundable price of reproduction for each full set of plans and documents.

Specifications, Plans, and Bid Documents may be examined at the following places:

LFUCG
Division of Central Purchasing
200 East Main Street, Third Floor, Rm 338
Lexington, Kentucky 40507
(859) 258-3320

Builder's Exchange
2300 Meadow Drive
Louisville, KY 40218

LFUCG
Division of Traffic Engineering
101 East Vine Street Suite 300
Lexington, Kentucky 40507
(859) 258-3830

4. METHOD OF RECEIVING BIDS

Bids will be received from KYTC Prequalified Prime Contracting firms on a Line Item Unit Price Basis for total Project. The Bidder must include a price for all bid items to be considered. Bids shall be submitted in the manner and subject to the conditions as set forth and described in the Instruction to Bidders and Special Conditions.

Sealed bids shall be clearly marked on the outside of the container as follows: Company Name and Address, Bid Invitation Number, and the Project Name. Bids are to remain sealed until official Bid closure time.

Mailed bids/proposals should be sent to the Director, Division of Central Purchasing, 200 East Main Street, Lexington, KY 40507.

5. METHOD OF AWARD

The Contract, if awarded, will be to the lowest, qualified responsible bidder for the total project whose qualifications indicate the award will be in the best interest of the OWNER and whose bid/proposal complies with all the prescribed requirements. No Notice of Award will be given until the OWNER has concluded such investigation as deemed necessary to establish the responsibility, qualifications and financial ability of Bidders to do the work in accordance with the Contract Documents to the satisfaction of the OWNER within the time prescribed. The OWNER reserves the right to reject the Bid of any Bidder who does not pass such investigation to the OWNER's satisfaction. In analyzing Bids, the OWNER may take into consideration alternate and unit prices, if requested by the Bid forms.

6. **BID WITHDRAWAL**

No bidder may withdraw his bid for a period of sixty (60) calendar days after the closing date for receipt of bids. Errors and omissions will not be cause for withdrawal of bid without forfeit of bid bond. Bids may be withdrawn in person prior to the closing date of receipt of bids.

7. **BID SECURITY**

If the bid is \$50,000 or greater, bid shall be accompanied by a certified /cashier's check or bid bond payable to the Lexington-Fayette Urban County Government in an amount not less than Five Percent (5%) of the base bid. Bid bond shall be executed by a Surety Company authorized to do business in the Commonwealth of Kentucky and countersigned by a licensed Kentucky Resident Agent, representing the Surety Company. Bid Bonds are not required for bids under \$50,000. A certified check or cashier's check is also acceptable forms of bid security.

8. **SUBMISSION OF BIDS**

CONTRACTORS shall submit their bids to the Lexington-Fayette Urban County Government, Division of Purchasing, Third Floor, 200 East Main Street, Lexington, Kentucky 40507. Bids shall be submitted in a sealed envelope not later than 2:00 p.m. local time, **February 27, 2018**. Sealed proposals shall be clearly marked on the outside of the container as follows: Company Name and Address, Bid Invitation Number, and Project Name to be opened at 2:00 p.m. local time **February 27, 2018**. Bids are to remain sealed until official Bid closure time. Bids received after the scheduled closing time for receipt of bids will not be considered and will be returned unopened.

9. **RIGHT TO REJECT**

The Lexington-Fayette Urban County Government reserves the right to reject any and all bids and to waive all informalities and/or technicalities where the best interest of the Lexington-Fayette Urban County Government may be served.

10. **NOTIFICATION TO THE LEXINGTON-FAYETTE URBAN COUNTY GOVERNMENT FOR AFFIRMATIVE ACTION PLAN AND CURRENT WORKFORCE**

The successful bidder must submit with their bid the following items to the Lexington-Fayette Urban County Government:

1. Affirmative Action Plan for his/her firm.
2. Current Workforce Analysis Form.

Failure to submit these items as required herein may result in disqualification of the Bidder from the award of the contract.

All submissions should be directed to:

Lexington-Fayette Urban County Government
Division of Purchasing
200 East Main Street, 3rd Floor, Room 338
Lexington, Kentucky 40507

11. NOTICE CONCERNING MWDBE and Veteran GOALS - LFUCG

Notice of requirement for Affirmative Action to ensure Equal Employment Opportunities and Disadvantaged Business Enterprises (DBE) Contract participation. Disadvantaged Business Enterprises (DBE) consists of Minority-Owned Business Enterprises (MBE) and Woman-Owned Business Enterprises (WBE).

The Lexington-Fayette Urban County Government has set a goal that not less than ten percent (10%) of the total value of this Contract be subcontracted to Disadvantaged Business Enterprises, which is made up of MBEs and WBEs, and set a goal that not less than three percent (3%) of the total value of this Contract be subcontracted to Veteran-Owned Small Businesses. The goals for the utilization of Disadvantaged Business Enterprises and Veteran-Owned Small Businesses as subcontractors are recommended goals. Contractor(s) who fail to meet such goals will be expected to provide written explanations to the Director of the Division of Purchasing of efforts they have made to accomplish the recommended goal, and the extent to which they are successful in accomplishing the recommended goal will be a consideration in the procurement process. Depending on the funding source, other DBE goals may apply.

For assistance in locating Disadvantaged Business Enterprise and Veteran-Owned Small Businesses as Subcontractors contact:

Sherita Miller, Division of Central Purchasing
Lexington-Fayette Urban County Government
200 East Main Street, 3rd Floor, Room 338
Lexington, Kentucky 40507
859-258-3323
smiller@lexingtonky.gov

12. NOTICE CONCERNING DBE GOAL - KYTC

Notice of requirement for Affirmative Action to ensure Equal Employment Opportunities and Disadvantaged Business Enterprise (DBE) contract participation.

The Kentucky Transportation Cabinet has set a recommended goal of not less than three percent (3%) of the total value of this contract be subcontracted to Disadvantaged Business Enterprises. DBE participation must be in compliance with the requirements of 49 CFR 26 and the policies of the Kentucky Transportation Cabinet. Bidders and DBE subcontractors must be prequalified with the Kentucky Transportation Cabinet and possess a Certificate of Eligibility at the time of the bid opening. All other subcontractors must be prequalified when accepting subcontracts.

13. PRE-BID MEETING

A non-mandatory pre-bid meeting will be held at 1:00 PM local time on January 2, 2018 at 200 E Main St, 3rd Floor Purchasing Conference Room, Lexington, KY.

14. EXCLUDED PARTIES LIST SYSTEM (EPLS/SAM)

Prior to project being awarded, LFUCG will verify that the contractor is not listed on an "Excluded Parties List System" (suspended or debarred), as identified within the "SAM" site at <http://www.sam.gov>.

The EPLS is an electronic, web-based system that identifies those parties excluded from receiving Federal contracts, certain subcontracts and certain types of Federal financial and non-financial assistance and benefits. The EPLS keeps its user community aware of administrative and statutory exclusions across the entire government, and individual barred from entering the United States. The user is able to search, view, and download both current and archived exclusions.

EPLS access is available from any personal computer with Internet connectivity and a minimum web browser of Netscape 4.04 Internet Explorer 4.04 or Internet Explorer 4.0 at <http://www.sam.gov>.

END OF SECTION



PART II
INFORMATION FOR BIDDERS

INDEX

1. RECEIPT AND OPENING OF BIDS
2. PREPARATION OF BID
3. SUBCONTRACTS
4. QUALIFICATION OF BIDDER
5. BID SECURITY
6. LIQUIDATED DAMAGES FOR FAILURE TO ENTER INTO CONTRACT
7. TIME OF COMPLETION AND LIQUIDATED DAMAGES
8. EXAMINATION OF CONTRACT DOCUMENTS AND SITE
9. ADDENDA AND INTERPRETATIONS
10. SECURITY FOR FAITHFUL PERFORMANCE
11. POWER OF ATTORNEY
12. TAXES AND WORKMEN'S COMPENSATION
13. LAWS AND REGULATIONS
14. EROSION AND SEDIMENT CONTROL AND PERMITS
15. PREVAILING WAGE LAW
16. AFFIRMATIVE ACTION PLAN
17. CONTRACT TIME
18. SUBSTITUTION OR "OR-EQUAL" ITEMS
19. ALTERNATE BIDS
20. SIGNING OF AGREEMENT
21. ASSISTANCE TO BE OFFERED TO DBE CONTRACTORS
22. DBE PARTICIPATION GOALS
23. REQUIRED SUBMITTALS
24. LFUCG NON-APPROPRIATION CLAUSE

PART II

INFORMATION FOR BIDDERS

1. RECEIPT AND OPENING OF BIDS

The Lexington-Fayette Urban County Government (herein called the OWNER) invites bids from firms on the project described in the Advertisement for Bids. The OWNER will receive bids at the Division of Purchasing, at the time and in the manner set forth in the Advertisement for Bids, and the Bids will then be publicly opened and read aloud. The OWNER may consider informal any bid not prepared and submitted in accordance with the provisions hereof and may waive any informalities or reject any and all bids. Any bid may be withdrawn prior to the scheduled time for the opening of bids or authorized postponement thereof. Any bid received after the time and date specified shall not be considered. No bidder may withdraw a bid within 60 days after the actual time and date of the bid opening, but OWNER may, in its sole discretion, release any bid and return the Bid Security prior to that date.

The Lexington-Fayette Urban County Government assumes no responsibility for bids that are not addressed and delivered as indicated above. Bids that are not delivered to the Division of Central Purchasing by the stated time and date will be rejected.

2. PREPARATION OF BID

Each bid must be submitted on the prescribed Form of Proposal. All blank spaces for the bid prices must be filled in, either in ink or typewritten, for both unit prices and extensions. Totals for each bid item must be added to show the total amount of the bid. Each bid must be submitted in a sealed envelope bearing on the outside the name of the bidder, their address, the name of the project, the invitation number and time and date for which the bid is submitted. Bids must be addressed to the Director of Purchasing, Lexington-Fayette Urban County Government, Third Floor, 200 East Main Street, Lexington, Kentucky 40507. If forwarded by mail, the sealed envelope containing the bid must be enclosed in another envelope addressed as specified above.

3. SUBCONTRACTS

The bidder is specifically advised that any person, firm, or other party to whom it is proposed to award a subcontract under this Contract must be acceptable to the OWNER. All proposed subcontractors must be identified on the Form of Proposal. Prior to the award of Contract, the OWNER or the OWNER'S representative will advise the CONTRACTOR of the acceptance and approval thereof or of any action necessary to be taken. Should any Subcontractor be rejected by the OWNER, the CONTRACTOR shall present a new name and/or firm to the OWNER at no change in the Contract Price.

4. QUALIFICATION OF BIDDER

The OWNER may make such investigations as the OWNER deems necessary to determine the ability of the bidder to perform the Work, and the bidder shall furnish to the OWNER all such information and data for this purpose as the OWNER may request. The OWNER reserves the right to reject any bid if the evidence submitted by, or investigation of, such bidder fails to satisfy the OWNER that such bidder is properly qualified to carry out the obligations of the Contract and to complete the Work contemplated therein. Conditional bids will not be accepted.

In evaluating Bids, OWNER shall consider the qualifications of the BIDDERS, whether or not the Bids comply with the prescribed requirements, and alternatives and unit prices, as requested. OWNER may consider maintenance requirements, performance data, and disruption or damage to private property. It is OWNER'S intent to accept alternatives, if requested by the bid forms, in the order in which they are listed in the Bid Form but OWNER may accept or decline them in any order or combination. The contract, if awarded, will be awarded to the lowest, qualified, responsible BIDDER based upon OWNER'S evaluation which indicates that the award will be in the best interest of OWNER and the general public.

In the event there is any question as to the bidder's qualifications and ability to complete the work, a final determination will be made in accordance with a fair evaluation by the Urban County Government of the above listed elements.

- A. If the OWNER requires filling out a detailed financial statement, the bidder may provide its current certified financial statement(s) for the required time interval.
- B. Corporate firms are required to be registered and in good standing with the requirements and provisions of the Office of the Secretary of State, Commonwealth of Kentucky.
- C. Documents Required of CONTRACTOR - (1) A sworn statement signed by the President or owner of the Company regarding all current work in progress anywhere; (2) A document showing the percent of completion of each project and the total worth of each project; and (3) Documentation showing the percentage of the DBE employment levels on each project of the Bidder's current work force, and DBE participation levels for Subcontractors.
- D. Optional OWNER Requirements - The OWNER, at its discretion, may require the BIDDER/CONTRACTOR to provide: (1) a current detailed financial statement for a period including up to 3 prior years; (2) financial security or insurance in amounts and kinds acceptable to the OWNER to meet the financial responsibility requirements for the CONTRACTOR to indemnify the OWNER. (3) Additional information and/or DBE work force data, as well as DBE participation data.

Each bidder agrees to waive any claim it has or may have against the Owner, the Consultant, and their respective employees, arising out of or in connection with the administration, evaluation, or recommendation of any bid.

- E. Bids will only be accepted from plan holders who have purchased plans from Lynn Imaging and are subsequently registered as "official plan holders." Bidders and DBE subcontractors must be prequalified with the Kentucky Transportation Cabinet and possess a Certificate of Eligibility at the time of the bid opening. All other subcontractors must be prequalified when accepting subcontracts.
- F. **Prequalified DBE list can be found at:**
<http://transportation.ky.gov/Civil-Rights-and-Small-Business-Development/Pages/Certified-and-Prequalified-DBEs.aspx>

5. **BID SECURITY**

- A. Each bid must be accompanied by a bid bond prepared on a Form of Bid Bond and attached hereto, duly executed by the bidder as principal and having as surety thereon a surety company approved by the OWNER, in the amount of 5% of the bid. Such bid bond will be returned to the unsuccessful bidder(s) only upon written request to the Director of Central Purchasing within seven (7) days of opening of bids. Bid bond shall be made payable to the Lexington-Fayette Urban County Government. Bid security is not required for projects under \$50,000.
- B. Bonds shall be placed with an agent licensed in Kentucky with surety authorized to do business within the state. When the premium is paid for such coverage, the full commission payable shall be paid to such local agent who shall not divide such commission with any person other than a duly licensed resident local agent.

6. **LIQUIDATED DAMAGES FOR FAILURE TO ENTER INTO CONTRACT**

The successful bidder, upon his failure or refusal to execute and deliver the Contract and bonds required within ten (10) days after he has received notice of the acceptance of his bid, shall forfeit to the OWNER, as liquidated damages for such failure or refusal, the security deposited with his bid.

7. **TIME OF COMPLETION AND LIQUIDATED DAMAGES**

It is mutually agreed by and between the parties hereto that time is of the essence of this Contract, and that there will be sustained by the OWNER damages, monetary and otherwise, in the event of delay in the completion of the Work hereby contracted. The CONTRACTOR will be held responsible to the OWNER for delays in completion of the Work herein contracted beyond the date set for completion. Completion is defined in Section 108.03 of the KDOH Standard Specifications, Current Edition. Such monetary damage shall be deducted from the Contract sum in the amount of SEVEN HUNDRED FIFTY DOLLARS **(\$750.00)** per calendar day of such delay. If the Work contracted to be done shall not, in good faith, be commenced at the time specified, then the CONTRACTOR together with the Surety or Sureties upon the bond herein provided for, shall be liable for and shall pay to the OWNER all damages sustained by reason of such failure for breach of Contract, and the OWNER may immediately re-let the Work involved.

Bidder must agree to commence work on or before a date to be specified in a written "Notice to Proceed" from the OWNER and to fully complete the Project within the time as specified in the Contract. Bidder must agree also to pay liquidated damages, or the sum as specified in the Contract for each consecutive calendar day thereafter as hereinafter provided in the General Conditions.

8. EXAMINATION OF CONTRACT DOCUMENTS AND SITE

- A. It is the responsibility of each Bidder before submitting a Bid, to (a) examine the Contract Documents thoroughly, (b) visit the site(s) to become familiar with local conditions that may affect cost, progress, performance or furnishing of the work, (c) consider Federal, State and Local laws and regulations that may affect cost, progress, performance or furnishing of the work, (d) study and carefully correlate Bidder's observations with the Contract Documents, and (e) notify Consultant of all conflicts, errors or discrepancies in the Contract Documents.

- B. Bidders should examine the requirements of section 4 of the General Conditions for information pertaining to subsurface conditions, underground structures, underground facilities, and availability of lands, easements, and rights-of-way. The completeness of data, presented in the Contract Documents, pertaining to subsurface conditions, underground structures, and underground facilities for the purposes of bidding or construction is not assured. The Bidder will, at Bidder's own expense, make or obtain any additional examinations, investigations, explorations, tests and studies and obtain any additional information and data which pertain to the physical conditions (surface and subsurface) which may affect cost, progress, performance or furnishing of the Work and which Bidder deems necessary to determine its Bid for performing and furnishing the Work in accordance with the time, price, and other terms and conditions of the Contract Documents. On request in advance, OWNER will provide access to the site to conduct such explorations and tests as each Bidder deems necessary for submission of a bid. Bidder shall fill all holes, clean up and restore the site to its former condition upon completion of such explorations.

- C. The submission of a Bid will constitute an incontrovertible representation by the Bidder that Bidder has complied with every requirement of this paragraph 8; that without exception the Bid is premised upon furnishing and performing the Work required by the Contract Documents and such means, methods, techniques, sequences or procedures of construction as may be indicated in or required by the Contract Documents; and that the Contract Documents are sufficient in scope and detail to indicate and convey understanding of all terms and conditions for performance and furnishing of the Work.

9. ADDENDA AND INTERPRETATIONS

No interpretation of the meaning of the Contract Documents will be made to any bidder orally. Every request for such interpretation should be in writing addressed to the Director of Central Purchasing, who in turn will have an Addendum issued for the Lexington-Fayette Urban County Government, and to be given consideration must be received prior to the date fixed for the opening of bids. Any and all such interpretations and any supplemental instructions will be in the form of written addenda to the specifications. Acknowledgement of the receipt of addenda must be included with all submitted bids. Failure of any bidder to receive any such addendum or interpretation shall not relieve such bidder from any obligation under his bid as submitted. All addenda so issued shall become part of the Contract Documents.

10. SECURITY FOR FAITHFUL PERFORMANCE

- A. Simultaneously with his delivery of the executed Contracts, the CONTRACTOR shall furnish a surety bond or bonds as security for the faithful performance of this Contract and for payment of all persons performing labor on the Project under this Contract and furnishing materials in

connection with this Contract, as specified in the General Conditions. The surety on such bond or bonds shall be a duly authorized surety company satisfactory to the OWNER and authorized to do business in the Commonwealth of Kentucky.

- B. All bonds required by this Contract and laws of this State shall be placed with agents licensed in the State of Kentucky. When the premium is paid for such coverage's, the full commission shall be paid to such local agent who shall not divide such commission with any person other than a duly licensed resident local agent.
- C. **Contractor shall use standard Performance and Payment Bond forms such as documents provided with this contract book or AIA form A312-1984 (or later). Each document will be for 100% of the Contract Bid Amount.**

11. POWER OF ATTORNEY

Attorney-in-fact who signs bid bonds or contract bonds must file with each bond a certified and effectively dated copy of their power of attorney.

12. TAXES AND WORKMEN'S COMPENSATION

The CONTRACTOR and subcontractor will be required to accept liability for payment of all payroll taxes, sales and use tax, and all other taxes or deductions required by local, state or federal law, such as old age pension, social security, or annuities measured by wages. Each shall carry Workmen's Compensation Insurance to the full amounts as required by Statutes and shall include the cost of all foregoing items in the proposal. The CONTRACTOR will not otherwise be reimbursed or compensated for such tax payments. The CONTRACTOR is urged to ascertain at his own risk his actual tax liability in connection with the execution or performance of his Contract.

13. LAWS AND REGULATIONS

The bidder's attention is directed to the fact that all applicable state laws, municipal ordinances, and the rules and regulations of all authorities having jurisdiction over construction of the Project shall apply to the Contract throughout, and they will be deemed to be included in the contract, the same as though herein written out in full.

14. EROSION AND SEDIMENT CONTROL AND PERMITS

The CONTRACTOR and Subcontractors performing work on projects on behalf of the OWNER shall also comply with all applicable federal, state, and local environmental regulations and all requirements and conditions set forth in "special" permits including but not limited to Corp of Engineers 404 permits, 401 Water Quality Certifications, Stream Crossing and Floodplain Encroachment Permits as described in Part 4 General Conditions Paragraph 5.17.

15. PREVAILING WAGE LAW AND MINIMUM HOURLY RATES

Federal wage rates and regulations, if required for this Project, will be as described in the Special Conditions.

16. AFFIRMATIVE ACTION PLAN

The successful Bidder must submit with their bid, the following items to the Urban County Government:

1. Certification of Bid Proposal/DBE – see Part III
2. KYTC DBE Provisions – see Part III
3. DBE Subcontractor Bidders List – see Part III

A Work Force Analysis Form shall be submitted for each Contract. Failure to submit these items as required herein may result in disqualification of the Bidder from award of the Contract.

All submissions should be directed to:

Director, Division of Central Purchasing
Lexington-Fayette Urban County Government
200 East Main Street, Third Floor
Lexington, KY 40507

17. CONTRACT TIME

The number of calendar days within which the Work is to be substantially completed and ready for final payment (the Contract Time) is set forth in the Form of Proposal and the Agreement.

18. SUBSTITUTE OR "OR-EQUAL" ITEMS

The Contract, if awarded, will be on the basis of materials and equipment described in the Drawings or specified in the Specifications without consideration of possible substitute or "or-equal" items. Whenever it is indicated in the Drawings or specified in the Specifications that a substitute or "or-equal" item of material or equipment may be furnished or used by the CONTRACTOR if acceptable to the CONSULTANT and OWNER, application for such acceptance will not be considered by the CONSULTANT and OWNER until after the effective date of the Agreement. The procedure for submission of any such application by the CONTRACTOR and consideration by the CONSULTANT and OWNER is set forth in the General Conditions.

19. ALTERNATE BIDS

Bidders shall submit alternate bids/proposals only if and when such alternate bids/proposals have been specifically requested in an Invitation for Bids. If alternate bids/proposals are requested in an Invitation for Bids, the form of submission of such alternate bid and the conditions under which such alternate bids will be considered for award of a contract will be established in the Invitation.

Any Bidder who submits a bid incorporating an alternate proposal when alternate bids/proposals have not been requested in the Invitation for Bids shall have his/her bid rejected as non-responsive.

Any Bidder who submits a bid incorporating two (2) or more prices for an item or groups of items (unless such method of pricing is requested in the Invitation for Bids), or which imposes conditions for acceptance other than those established in the Invitation for Bids, shall have their bid rejected as non-responsive.

20. SIGNING OF AGREEMENT

When OWNER gives a Notice of Award to the successful Bidder, it will be accompanied by the required number of unsigned counterparts of the Agreement with all other written Contract Documents attached. Within ten days thereafter, CONTRACTOR shall sign and deliver the required number of counterparts of the Agreement and attached documents to OWNER with the required Bonds, Certificate of Insurance, and Power of Attorney. The OWNER will deliver one fully signed counterpart to CONTRACTOR at such time as it has been signed by the Mayor.

21. ASSISTANCE TO BE OFFERED TO DISADVANTAGED BUSINESS ENTERPRISE (MWDBE) CONTRACTORS

A. Outreach for MWDBE(s)

The Lexington-Fayette Urban County Government (LFUCG) maintains a database of MWDBE contractors and organizations. When a LFUCG construction project is advertised for bidding, notices are sent to companies registered at <https://lexingtonky.ionwave.net>. The notices describe the project and indicate the deadline for submitting bids.

If you wish to be added to the LFUCG MWDBE contractor database, please contact:

Sherita Miller, Division of Central Purchasing
Lexington-Fayette Urban County Government
200 East Main Street, Room 338
Lexington, Kentucky 40507
smiller@lexingtonky.gov

B. Bid Bond Assistance for MWDBE(s)

For those MWDBE contractors who wish to bid on LFUCG project, bid bond assistance is available. This bid bond assistance is in the form of a "Letter of Certification" which is accepted by the LFUCG's Division of Purchasing, in lieu of a bid bond. The "Letter of Certification" must be included in the bid package when it is submitted to the Division of Purchasing. The "Letter of Certification" will reference the specific project for which the bid is being submitted, and the time and date on which the bid is due. Bid bond assistance must be requested from the Lexington-Fayette Urban County Government's Division of Central Purchasing.

C. Eligibility for Bid Bond Assistance for MWDBE(s)

In order to be eligible for any Bid bonding assistance, a MWDBE construction company must be owned or controlled at the level of 51% or more by a member or members of a minority group or females. Prior to receiving assistance, a statement providing evidence of ownership and control of the company by a member or members of a minority group or females must be signed by the Owner or corporate officer and by an attorney or accountant submitted to:

Sherita Miller, Division of Central Purchasing
Lexington-Fayette Urban County Government
200 East Main Street, Room 338
Lexington, Kentucky 40507
smiller@lexingtonky.gov

D. MWDBE Subcontractors

The LFUCG will, upon request, assist prime contractors in the procurement of eligible DBE subcontractors in an effort to achieve 10% minimum MWDBE goal.

For a list of eligible subcontractors, please contact:

Sherita Miller, Division of Central Purchasing
Lexington-Fayette Urban County Government
200 East Main Street, Room 338
Lexington, Kentucky 40507
smiller@lexingtonky.gov

22. MWDBE PARTICIPATION GOALS

A. GENERAL

- 1) The LFUCG request all potential contractors to make a concerted effort to include Minority-Owned (MBE), Woman-Owned (WBE), Disadvantaged (DBE) Business Enterprises and Veteran-Owned Small Businesses (VOSB) as subcontractors or suppliers in their bids.
- 2) Toward that end, the LFUCG has established 10% of total procurement costs as a Goal for participation of Minority-Owned, Woman-Owned and Disadvantaged Businesses on this contract.
- 3) **It is therefore a request of each Bidder to include in its bid, the same goal (10%) for MWDBE participation and other requirements as outlined in this section.**
- 4) The LFUCG has also established a 3% of total procurement costs as a Goal for participation for of Veteran-Owned Businesses.
- 5) **It is therefore a request of each Bidder to include in its bid, the same goal (3%) for Veteran-Owned participation and other requirements as outlined in this section.**

B. PROCEDURES

- 1) The successful bidder will be required to report to the LFUCG, the dollar amounts of all payments submitted to Minority-Owned, Woman-Owned or Veteran-Owned subcontractors and suppliers for work done or materials purchased for this contract. (See Subcontractor

Monthly Payment Report)

- 2) Replacement of a Minority-Owned, Woman-Owned or Veteran-Owned subcontractor or supplier listed in the original submittal must be requested in writing and must be accompanied by documentation of Good Faith Efforts to replace the subcontractor / supplier with another MWDBE Firm; this is subject to approval by the LFUCG. (See LFUCG MWDBE Substitution Form)
- 3) For assistance in identifying qualified, certified businesses to solicit for potential contracting opportunities, bidders may contact:
 - a) The Lexington-Fayette Urban County Government, Division of Central Purchasing (859-258-3320)
- 4) The LFUCG will make every effort to notify interested MWDBE and Veteran-Owned subcontractors and suppliers of each Bid Package, including information on the scope of work, the pre-bid meeting time and location, the bid date, and all other pertinent information regarding the project.

C. DEFINITIONS

- 1) A Minority-Owned Business Enterprise (MBE) is defined as a business which is certified as being at least 51% owned, managed and controlled by persons of African American, Hispanic, Asian, Pacific Islander, American Indian or Alaskan Native Heritage.
- 2) A Woman-Owned Business Enterprise (WBE) is defined as a business which is certified as being at least 51% owned, managed and controlled by one or more women.
- 3) A Disadvantaged Business (DBE) is defined as a business which is certified as being at least 51% owned, managed and controlled by a person(s) that are economically and socially disadvantaged.
- 4) A Veteran-Owned Small Business (VOSB) is defined as a business which is certified as being at least 51% owned, managed and controlled by a veteran and/or a service disabled veteran.
- 5) Good Faith Efforts are efforts that, given all relevant circumstances, a bidder or proposer actively and aggressively seeking to meet the goals, can reasonably be expected to make. In evaluating good faith efforts made toward achieving the goals, whether the bidder or proposer has performed the efforts outlined in the Obligations of Bidder for Good Faith Efforts outlined in this document will be considered, along with any other relevant factors.

D. OBLIGATION OF BIDDER FOR GOOD FAITH EFFORTS

- 1) **The bidder shall make a Good Faith Effort to achieve the Participation Goal for MWDBE and Veteran-Owned subcontractors/suppliers. The failure to meet the goal shall not necessarily be cause for disqualification of the bidder; however, bidders not meeting the goal are required to furnish with their bids written documentation of their Good Faith Efforts to do so.**
- 2) Award of Contract shall be conditioned upon satisfaction of the requirements set forth herein.

- 3) The Form of Proposal includes a section entitled "MWDBE Participation Form". The applicable information must be completed and submitted as outlined below. **Failure to submit this information as requested may be cause for rejection of bid or delay in contract award.**
- 4) Part III The Form of Proposal, includes a section entitled "KENTUCKY TRANSPORTATION CABINET-DISADVANTAGED BUSINESS ENTERPRISE PROVISIONS". **There is a three percent (3%) required DBE Goal on this project** The applicable information must be completed and submitted as outlined in that document. **Failure to submit this information as requested will be cause for rejection of bid.**

E. DOCUMENTATION REQUIRED FOR GOOD FAITH EFFORTS

- 1) Bidders reaching the Goal are required to submit only the MWDBE Participation Form." The form must be fully completed including names and telephone number of participating MWDBE firm(s); type of work to be performed; estimated value of the contract and value expressed as a percentage of the total Lump Sum Bid Price. The form must be signed and dated, and is to be submitted with the bid.
- 2) Bidders not reaching the Goal must submit the "MWDBE Participation Form", the "Quote Summary Form" and a written statement documenting their Good Faith Effort to do so. If bid includes no MWDBE and/or Veteran participation, bidder shall enter "None" on the subcontractor / supplier form). In addition, the bidder must submit written proof of their Good Faith Efforts to meet the Participation Goal:
 - a. Advertised opportunities to participate in the contract in at least two (2) publications of general circulation media; trade and professional association publications; small and minority business or trade publications; and publications or trades targeting minority, women and disadvantaged businesses not less than fifteen (15) days prior to the deadline for submission of bids to allow MWDBE firms and Veteran-Owned businesses to participate.
 - b. Included documentation of advertising in the above publications with the bidders good faith efforts package
 - c. Attended LFUCG Central Purchasing Economic Inclusion Outreach event
 - d. Attended pre-bid meetings that were scheduled by LFUCG to inform MWDBEs and/or Veteran-Owned businesses of subcontracting opportunities
 - e. Sponsored Economic Inclusion event to provide networking opportunities for prime contractors and MWDBE firms and Veteran-Owned businesses.
 - f. Requested a list of MWDBE and/or Veteran subcontractors or suppliers from LFUCG and showed evidence of contacting the companies on the list(s).
 - g. Contacted organizations that work with MWDBE companies for assistance in finding certified MWBDE firms and Veteran-Owned businesses to work on this project. Those contacted and their responses should be a part of the bidder's good faith efforts documentation.
 - h. Sent written notices, by certified mail, email or facsimile, to qualified, certified

MWDBEs and/or Veteran-Owned businesses soliciting their participation in the contract not less than seven (7) days prior to the deadline for submission of bids to allow them to participate effectively.

- i. Followed up initial solicitations by contacting MWDBEs and Veteran-Owned Businesses to determine their level of interest.
- j. Provided the interested MWDBE firm and/or Veteran-Owned business with adequate and timely information about the plans, specifications, and requirements of the contract.
- k. Selected portions of the work to be performed by MWDBE firms and/or Veteran-Owned businesses in order to increase the likelihood of meeting the contract goals. This includes, where appropriate, breaking out contract work items into economically feasible units to facilitate MWDBE and Veteran participation, even when the prime contractor may otherwise perform these work items with its own workforce
- l. Negotiated in good faith with interested MWDBE firms and Veteran-Owned businesses not rejecting them as unqualified without sound reasons based on a thorough investigation of their capabilities. Any rejection should be so noted in writing with a description as to why an agreement could not be reached.
- m. Included documentation of quotations received from interested MWDBE firms and Veteran-Owned businesses which were not used due to uncompetitive pricing or were rejected as unacceptable and/or copies of responses from firms indicating that they would not be submitting a bid.
- n. Bidder has to submit sound reasons why the quotations were considered unacceptable. The fact that the bidder has the ability and/or desire to perform the contract work with its own forces will not be considered a sound reason for rejecting a MWDBE and/or Veteran-Owned business's quote. Nothing in this provision shall be construed to require the bidder to accept unreasonable quotes in order to satisfy MWDBE and Veteran goals.
- o. Made an effort to offer assistance to or refer interested MWDBE firms and Veteran-Owned businesses to obtain the necessary equipment, supplies, materials, insurance and/or bonding to satisfy the work requirements of the bid proposal
- p. Made efforts to expand the search for MWBE firms and Veteran-Owned businesses beyond the usual geographic boundaries.
- q. Other--any other evidence that the bidder submits which may show that the bidder has made reasonable good faith efforts to include MWDBE and Veteran participation.

Note: Failure to submit any of the documentation requested in this section may be cause for rejection of bid. Bidders may include any other documentation deemed relevant to this requirement which is subject to review by the MBE Liaison. Documentation of Good Faith Efforts must be submitted with the Bid, if the participation Goal is not met.



MINORITY BUSINESS ENTERPRISE PROGRAM

Sherita Miller, MPA
Minority Business Enterprise Liaison
Division of Central Purchasing
Lexington-Fayette Urban County Government
200 East Main Street
Lexington, KY 40507
smiller@lexingtonky.gov
859-258-3323

OUR MISSION: The mission of the Minority Business Enterprise Program is to facilitate the full participation of minority and women owned businesses in the procurement process and to promote economic inclusion as a business imperative essential to the long term economic viability of Lexington-Fayette Urban County Government.

To that end the city council adopted and implemented Resolution 484-2017 – A Certified Minority, Women and Disadvantaged Business Enterprise ten percent (10%) minimum goal and a three (3%) minimum goal for Certified Veteran-Owned Small Businesses and Certified Service Disabled Veteran – Owned Businesses for government contracts.

The resolution states the following definitions shall be used for the purposes of reaching these goals (a full copy is available in Central Purchasing):

Certified Disadvantaged Business Enterprise (DBE) – a business in which at least fifty-one percent (51%) is owned, managed and controlled by a person(s) who is socially and economically disadvantaged as defined by 49 CFR subpart 26.

Certified Minority Business Enterprise (MBE) – a business in which at least fifty-one percent (51%) is owned, managed and controlled by an ethnic minority (i.e. African American, Asian American/Pacific Islander, Hispanic Islander, Native American/Native Alaskan Indian) as defined in federal law or regulation as it may be amended from time-to-time.

Certified Women Business Enterprise (WBE) – a business in which at least fifty-one percent (51%) is owned, managed and controlled by a woman.

Certified Veteran-Owned Small Business (VOSB) – a business in which at least fifty-one percent (51%) is owned, managed and controlled by a veteran who served on active duty with the U.S. Army, Air Force, Navy, Marines or Coast Guard.

Certified Service Disabled Veteran Owned Small Business (SDVOSB) – a business in which at least fifty-one percent (51%) is owned, managed and controlled by a disabled veteran who served on active duty with the U.S. Army, Air Force, Navy, Marines or Coast Guard.

The term “Certified” shall mean the business is appropriately certified, licensed, verified, or validated by an organization or entity recognized by the Division of Purchasing as having the appropriate credentials to make a determination as to the status of the business.

We have compiled the list below to help you locate certified MBE, WBE and DBE certified businesses. Below is a listing of contacts for LFUCG Certified MWDBEs and Veteran-Owned Small Businesses in (<https://lexingtonky.ionwave.net>)

Business	Contact	Email Address	Phone
LFUCG	Sherita Miller	smiller@lexingtonky.gov	859-258-3323
Commerce Lexington – Minority Business Development	Tyrone Tyra	tyra@commercelexington.com	859-226-1625
Tri-State Minority Supplier Diversity Council	Susan Marston	smarston@tsmsdc.com	502-365-9762
Small Business Development Council	Shawn Rogers UK SBDC	shawn.rogers@uky.edu	859-257-7666
Community Ventures Corporation	Phyllis Alcorn	palcorn@cvky.org	859-231-0054
KY Transportation Cabinet (KYTC)	Melvin Bynes	Melvin.bynes2@ky.gov	502-564-3601
KYTC Pre-Qualification	Sheila Eagle	Sheila.Eagle@ky.gov	502-782-4815
Ohio River Valley Women’s Business Council (WBENC)	Sheila Mixon	smixon@orvwbc.org	513-487-6537
Kentucky MWBE Certification Program	Yvette Smith, Kentucky Finance Cabinet	Yvette.Smith@ky.gov	502-564-8099
National Women Business Owner’s Council (NWBOC)	Janet Harris-Lange	janet@nwbec.org	800-675-5066
Small Business Administration	Robert Coffey	robertcoffey@sba.gov	502-582-5971
LaVoz de Kentucky	Andres Cruz	lavozdeky@yahoo.com	859-621-2106
The Key News Journal	Patrice Muhammad	production@keynewsjournal.com	859-685-8488

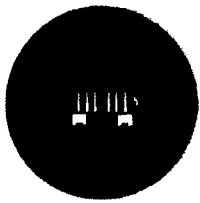

LFUCG MWDBE PARTICIPATION FORM

Bid/RFP/Quote Reference # _____

The MWDBE and/or veteran subcontractors listed have agreed to participate on this Bid/RFP/Quote. If any substitution is made or the total value of the work is changed prior to or after the job is in progress, it is understood that those substitutions must be submitted to Central Purchasing for approval immediately. **Failure to submit a completed form may cause rejection of the bid.**

MWDBE Company, Name, Address, Phone, Email	MBE WBE or DBE	Work to be Performed	Total Dollar Value of the Work	% Value of Total Contract
1.				
2.				
3.				
4.				

The undersigned company representative submits the above list of MWDBE firms to be used in accomplishing the work contained in this Bid/RFP/Quote. Any misrepresentation may result in the termination of the contract and/or be subject to applicable Federal and State laws concerning false statements and false claims.

Company

Company Representative

Date

Title

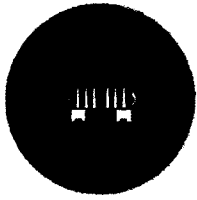

LFUCG MWDBE SUBSTITUTION FORM
Bid/RFP/Quote Reference # _____

The substituted MWDBE and/or veteran subcontractors listed below have agreed to participate on this Bid/RFP/Quote. These substitutions were made prior to or after the job was in progress. These substitutions were made for reasons stated below and are now being submitted to Central Purchasing for approval. By the authorized signature of a representative of our company, we understand that this information will be entered into our file for this project.

SUBSTITUTED MWDBE Company Name, Address, Phone, Email	MWDBE Formally Contracted/ Name, Address, Phone, Email	Work to Be Performed	Reason for the Substitution	Total Dollar Value of the Work	% Value of Total Contract
1.					
2.					
3.					
4.					

The undersigned acknowledges that any misrepresentation may result in termination of the contract and/or be subject to applicable Federal and State laws concerning false statements and false claims.

Company

Company Representative

Date

Title



MWDBE QUOTE SUMMARY FORM

Bid/RFP/Quote Reference # _____

The undersigned acknowledges that the minority and/or veteran subcontractors listed on this form did submit a quote to participate on this project. Failure to submit this form may cause rejection of the bid.

Company Name	Contact Person
Address/Phone/Email	Bid Package / Bid Date

MWDBE Company Address	Contact Person	Contact Information (work phone, Email, cell)	Date Contacted	Services to be performed	Method of Communication (email, phone meeting, ad, event etc)	Total dollars \$\$ Do Not Leave Blank (Attach Documentation)	MBE * AA HA AS NA Female	Veteran

(MBE designation / AA=African American / HA= Hispanic American/AS = Asian American/Pacific Islander/ NA= Native American)

The undersigned acknowledges that all information is accurate. Any misrepresentation may result in termination of the contract and/or be subject to applicable Federal and State laws concerning false statements and claims.

Company

Company Representative

Date

Title

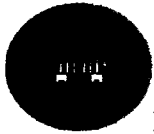

LFUCG SUBCONTRACTOR MONTHLY PAYMENT REPORT

The LFUCG has a 10% goal plan adopted by city council to increase the participation of minority and women owned businesses in the procurement process. The LFUCG also has a 3% goal plan adopted by cited council to increase the participation of veteran owned businesses in the procurement process. In order to measure that goal LFUCG will track spending with MWDBE and Veteran contractors on a monthly basis. By the signature below of an authorized company representative, you certify that the information is correct, and that each of the representations set forth below is true. Any misrepresentation may result in termination of the contract and/or prosecution under applicable Federal and State laws concerning false statements and false claims. Please submit this form monthly to the Division of Central Purchasing/ 200 East Main Street / Room 338 / Lexington, KY 40507.

Bid/RFP/Quote # _____

Total Contract Amount Awarded to Prime Contractor for this Project _____

Project Name/ Contract #	Work Period/ From:	To:
Company Name:	Address:	
Federal Tax ID:	Contact Person:	

Subcontractor Vendor ID (name, address, phone, email)	Description of Work	Total Subcontract Amount	% of Total Contract Awarded to Prime for this Project	Total Amount Paid for this Period	Purchase Order number for subcontractor work (please attach PO)	Scheduled Project Start Date	Scheduled Project End Date

By the signature below of an authorized company representative, you certify that the information is correct, and that each of the representations set forth below is true. Any misrepresentations may result in the termination of the contract and/or prosecution under applicable Federal and State laws concerning false statements and false claims.

Company

Company Representative

Date

Title

LFUCG STATEMENT OF GOOD FAITH EFFORTS

Bid/RFP/Quote # _____

By the signature below of an authorized company representative, we certify that we have utilized the following Good Faith Efforts to obtain the maximum participation by MWDBE and Veteran-Owned business enterprises on the project and can supply the appropriate documentation.

_____ Advertised opportunities to participate in the contract in at least two (2) publications of general circulation media; trade and professional association publications; small and minority business or trade publications; and publications or trades targeting minority, women and disadvantaged businesses not less than fifteen (15) days prior to the deadline for submission of bids to allow MWDBE firms and Veteran-Owned businesses to participate.

_____ Included documentation of advertising in the above publications with the bidders good faith efforts package

_____ Attended LFUCG Central Purchasing Economic Inclusion Outreach event

_____ Attended pre-bid meetings that were scheduled by LFUCG to inform MWDBEs and/or Veteran-Owned Businesses of subcontracting opportunities

_____ Sponsored Economic Inclusion event to provide networking opportunities for prime contractors and MWDBE firms and Veteran-Owned businesses

_____ Requested a list of MWDBE and/or Veteran subcontractors or suppliers from LFUCG and showed evidence of contacting the companies on the list(s).

_____ Contacted organizations that work with MWDBE companies for assistance in finding certified MWBDE firms and Veteran-Owned businesses to work on this project. Those contacted and their responses should be a part of the bidder's good faith efforts documentation.

_____ Sent written notices, by certified mail, email or facsimile, to qualified, certified MWDBEs soliciting their participation in the contract not less than seven (7) days prior to the deadline for submission of bids to allow them to participate effectively.

_____ Followed up initial solicitations by contacting MWDBEs and Veteran-Owned businesses to determine their level of interest.

_____ Provided the interested MWBDE firm and/or Veteran-Owned business with adequate and timely information about the plans, specifications, and requirements of the contract.

_____ Selected portions of the work to be performed by MWDBE firms and/or Veteran-Owned businesses in order to increase the likelihood of meeting the contract goals. This includes, where appropriate, breaking out contract work items into economically feasible units to facilitate MWDBE and Veteran

participation, even when the prime contractor may otherwise perform these work items with its own workforce

_____ Negotiated in good faith with interested MWDBE firms and Veteran-Owned businesses not rejecting them as unqualified without sound reasons based on a thorough investigation of their capabilities. Any rejection should be so noted in writing with a description as to why an agreement could not be reached.

_____ Included documentation of quotations received from interested MWDBE firms and Veteran-Owned businesses which were not used due to uncompetitive pricing or were rejected as unacceptable and/or copies of responses from firms indicating that they would not be submitting a bid.

_____ Bidder has to submit sound reasons why the quotations were considered unacceptable. The fact that the bidder has the ability and/or desire to perform the contract work with its own forces will not be considered a sound reason for rejecting a MWDBE and/or Veteran-Owned business's quote. Nothing in this provision shall be construed to require the bidder to accept unreasonable quotes in order to satisfy MWDBE and Veteran goals.

_____ Made an effort to offer assistance to or refer interested MWDBE firms and Veteran-Owned businesses to obtain the necessary equipment, supplies, materials, insurance and/or bonding to satisfy the work requirements of the bid proposal

_____ Made efforts to expand the search for MWBE firms and Veteran-Owned businesses beyond the usual geographic boundaries.

_____ Other--any other evidence that the bidder submits which may show that the bidder has made reasonable good faith efforts to include MWDBE and Veteran participation.

NOTE: Failure to submit any of the documentation requested in this section may be cause for rejection of bid. Bidders may include any other documentation deemed relevant to this requirement which is subject to approval by the MBE Liaison. Documentation of Good Faith Efforts must be submitted with the Bid, if the participation Goal is not met.

The undersigned acknowledges that all information is accurate. Any misrepresentations may result in termination of the contract and/or be subject to applicable Federal and State laws concerning false statements and claims.

Company

Company Representative

Date

Title

23. REQUIRED SUBMITTALS

The entire proposal must be completed and submitted or your bid will be considered non-responsive and rejected.

24. LFUCG NON-APPROPRIATION CLAUSE

Contractor acknowledges that the LFUCG is a governmental entity, and the contract validity is based upon the availability of public funding under the authority of its statutory mandate.

In the event that public funds are unavailable and not appropriated for the performance of the LFUCG's obligations under this contract, then this contract shall automatically expire without penalty to the LFUCG thirty (30) days after written notice to Contractor of the unavailability and non-appropriation of public funds. It is expressly agreed that the LFUCG shall not activate this non-appropriation provision for its convenience or to circumvent the requirements of this contract, but only as an emergency fiscal measure during a substantial fiscal crisis, which affects generally its governmental operations.

In the event of a change in the LFUCG's statutory authority, mandate and mandated functions, by state and federal legislative or regulatory action, which adversely affects the LFUCG's authority to continue its obligations under this contract, then this contract shall automatically terminate without penalty to the LFUCG upon written notice to Contractor of such limitation or change in the LFUCG's legal authority.

END OF SECTION



PART III
FORM OF PROPOSAL

INDEX

1. FORM OF PROPOSAL
2. LEGAL STATUS OF BIDDER
3. BIDDERS AFFIDAVIT
4. BID SCHEDULE – SCHEDULE OF VALUES
5. STATEMENT OF BIDDER'S QUALIFICATIONS
6. LIST OF PROPOSED SUBCONTRACTORS
7. LIST OF MATERIALS /SUPPLIERS
8. DBE SUB-CONTRACTOR BIDDERS LIST
9. CERTIFICATION FOR FEDERAL-AID CONTRACTS
10. CERTIFICATION OF PERFORMANCE
11. CERTIFICATION OF ORGANIZATION(S)
12. CERTIFICATION OF BID PROPOSAL / DBE
13. KENTUCKY TRANSPORTATION CABINET–DISADVANTAGED BUSINESS
ENTERPRISE PROVISIONS
14. NON-COLLUSION CERTIFICATION
15. STATEMENT OF EXPERIENCE
16. EQUAL OPPORTUNITY AGREEMENT
17. EQUAL EMPLOYMENT OPPORTUNITY AFFIRMATIVE
ACTION POLICY
18. WORKFORCE ANALYSIS FORM
19. EVIDENCE OF INSURABILITY
20. DEBARRED FIRMS
21. DEBARMENT CERTIFICATION
22. PROVISIONS RELATIVE TO SENATE BILL 258 (1994)
23. EXECUTIVE BRANCH CODE OF ETHICS



PART III

Invitation to Bid No. 15-2018

**Winchester Road, East Seventh Street, Liberty Road
Intersection Improvements Project**

1. **FORM OF PROPOSAL**

Place: Lexington, Kentucky

Date: _____

The following Form of Proposal shall be followed exactly in submitting a proposal for this Work.

This Proposal Submitted by _____

(Name and Address of Bidding Contractor)

(Hereinafter called "Bidder"), organized and existing under the laws of the State of _____, doing business as _____
"a corporation," "a partnership", or an "individual" as applicable.

To: Lexington-Fayette Urban County Government
(Hereinafter called "OWNER")
Office of the Director of Purchasing
200 East Main Street, 3rd Floor
Lexington, KY 40507

Gentlemen:

The Bidder, in compliance with your Invitation for Bids for the **Winchester Road, East Seventh Street, Liberty Road Intersection Improvements Project** having examined the Plans and Specifications with related documents, having examined the site for proposed Work, and being familiar with all of the conditions surrounding the construction of the proposed Project, including the availability of materials and labor, hereby proposes to furnish all labor, materials, and supplies, and to construct the Project in accordance with the Contract Documents, within the time set forth therein, and at the lump sum and/or unit prices stated hereinafter. These prices are to cover all expenses incurred in performing the Work required under the Contract Documents, of which this proposal is a part.

BIDDER hereby agrees to commence work under this contract as to be specified in the Notice to Proceed and to fully complete the project within **one-hundred and eighty (180) consecutive calendar days** thereafter. BIDDER further agrees to pay liquidated damages, the sum of \$750.00 for each consecutive calendar day thereafter.

The Bidder hereby acknowledges receipt of the following addenda:

Addendum No. _____ Date _____

Addendum No. _____ Date _____

Addendum No. _____ Date _____

Addendum No. _____ Date _____

Addendum No. _____ Date _____

Addendum No. _____ Date _____

Addendum No. _____ Date _____

Addendum No. _____ Date _____

Insert above the number and the date of any Addendum issued and received. If none has been issued and received, the word "NONE" should be inserted.

2. **LEGAL STATUS OF BIDDER**

Bidder _____

Date _____

* 1. A corporation duly organized and doing business under the laws of the State of _____, for whom _____, bearing the official title of _____, whose signature is affixed to this Bid/Proposal, is duly authorized to execute contracts.

* 2. A Partnership, all of the members of which, with addresses are: (Designate general partners as such)

* 3. An individual, whose signature is affixed to this Bid/Proposal (please print name)

*(The Bidder shall fill out the appropriate form and strike out the other two.)

3. BIDDERS AFFIDAVIT

**REQUIRED AFFIDAVIT FOR BIDDERS, OFFERORS AND CONTRACTORS
FOR BIDS AND CONTRACTS IN GENERAL:**

I. Each bidder or offeror swears and affirms under penalty of perjury, that:

a. In accordance with KRS 45A.110 and KRS 45A.115, neither the bidder or offeror as defined in KRS 45A.070(6), nor the entity which he/she represents, has knowingly violated any provisions of the campaign finance laws of the Commonwealth of Kentucky; and the award of a contract to the bidder or offeror or the entity which he/she represents will not violate any provisions of the campaign finance laws of the Commonwealth.

b. The bidder or offeror swears and affirms under penalty of perjury that, to the extent required by Kentucky law, the entity bidding, and all subcontractors therein, are aware of the requirements and penalties outlined in KRS 45A.485; have properly disclosed all information required by this statute; and will continue to comply with such requirements for the duration of any contract awarded.

c. The bidder or offeror swears and affirms under penalty of perjury that, to the extent required by Kentucky law, the entity bidding, and its affiliates, are duly registered with the Kentucky Department of Revenue to collect and remit the sales and use tax imposed by KRS Chapter 139, and will remain registered for the duration of any contract awarded.

d. The bidder or offeror swears and affirms under penalty of perjury that the entity bidding is not delinquent on any state taxes or fees owed to the Commonwealth of Kentucky and will remain in good standing for the duration of any contract awarded.

**FOR "NON-BID" CONTRACTS (I.E. SOLE-SOURCE; NOT-PRACTICAL OR
FEASIBLE TO BID; OR EMERGENCY CONTRACTS, ETC):**

II. Each contractor further swears and affirms under penalty of perjury, that:

a. In accordance with KRS 121.056, and if this is a non-bid contract, neither the contractor, nor any member of his/her immediate family having an interest of 10% or more in any business entity involved in the performance of any contract awarded, have contributed more than the amount specified in KRS 121.150 to the campaign of the gubernatorial slate elected in the election last preceding the date of contract award.

b. In accordance with KRS 121.330(1) and (2), and if this is a non-bid contract, neither the contractor, nor officers or employees of the contractor or any entity affiliated with the contractor, nor the spouses of officers or employees of the

contractor or any entity affiliated with the contractor, have knowingly contributed more than \$5,000 in aggregate to the campaign of a candidate elected in the election last preceding the date of contract award that has jurisdiction over this contract award.

c. In accordance with KRS 121.330(3) and (4), and if this is a non-bid contract, to the best of his/her knowledge, neither the contractor, nor any member of his/her immediate family, his/her employer, or his/her employees, or any entity affiliated with any of these entities or individuals, have directly solicited contributions in excess of \$30,000 in the aggregate for the campaign of a candidate elected in the election last preceding the date of contract award that has jurisdiction over this contract.

As a duly authorized representative for the bidder, offeror, or contractor, I have fully informed myself regarding the accuracy of all statements made in this affidavit, and acknowledge that the Commonwealth is reasonably relying upon these statements, in making a decision for contract award and any failure to accurately disclose such information may result in contract termination, repayment of funds and other available remedies under law.

BIDDERS AFFIDAVIT (LFUCG)

Comes the Affiant, _____, and after being first duly sworn, states under penalty of perjury as follows:

1. His/her name is _____ and he/she is the individual submitting the bid or is the authorized representative of _____, the entity submitting the bid (hereinafter referred to as "Bidder").
2. Bidder will pay all taxes and fees, which are owed to the Lexington-Fayette Urban County Government at the time the bid is submitted, prior to award of the contract and will maintain a "current" status in regard to those taxes and fees during the life of the contract.
3. Bidder will obtain a Lexington-Fayette Urban County Government business license, if applicable, prior to award of the contract.
4. Bidder has authorized the Division of Central Purchasing to verify the above-mentioned information with the Division of Revenue and to disclose to the Urban County Council that taxes and/or fees are delinquent or that a business license has not been obtained.
5. Bidder has not knowingly violated any provision of Chapter 25 of the Lexington-Fayette Urban County Government Code of Ordinances, known as the "Ethics Act."
6. Bidder acknowledges that "knowingly" for purposes of this Affidavit means, with respect to conduct or to circumstances described by a statute or ordinance defining an offense, that a person is aware or should have been aware that his conduct is of that nature or that the circumstance exists.

(Affiant)

STATE OF _____

COUNTY OF _____

The foregoing instrument was subscribed, sworn to and acknowledged before me by _____ on this the _____ day of _____, 20_____.

My Commission expires: _____

NOTARY PUBLIC, STATE AT LARGE

4. **BID SCHEDULE – SCHEDULE OF VALUES**

The Bidder agrees to perform all the Work described in the Specifications and shown on the Plans for the following proposed lump sum and/or unit prices, if applicable, which shall include the furnishing of all labor, materials, supplies, equipment and/or vehicle usage, services, all items of cost, overhead, taxes (federal, state, local), and profit for the Contractor and any Subcontractor involved, within the time set forth herein. If unit prices are applicable, Bidder must make the extensions and additions showing the total amount of bid.

If a discrepancy between the unit price and the item total exists, the unit price prevails except:

If the unit price is illegible, omitted, or the same as the item total, item total prevails and the unit price is the quotient of the item total and the quantity.

If the unit price and the item total are illegible or are omitted, the bid may be determined nonresponsive. If a lump sum total price is illegible or is omitted, the bid may be determined nonresponsive.

For a unit price based bid, the sum of the item totals is the bid amount the Division uses for bid comparison.

The LFUCG's decision on the bid amount is final.

The contract, if awarded, will be on the basis of materials and equipment specified in the specifications without consideration of possible substitute or "or equal" items.

The estimated quantities of items of unit price work are not guaranteed and are solely for the purpose of comparison of bids and determining an initial Contract price. Determination of the actual quantities and classification of unit price work performed by the Contractor will be made by the Engineer in accordance with the General Conditions.

Payment:

Accepted quantities for Work shall be paid for at their respective Contract "Unit Price" as quoted (which shall be for all Work required under this Section) and paid per "Unit To Bid On" of specified "Description" satisfactorily placed. All labor, materials, equipment, and excavation shall be incidental to the Work.

Digital Bid Submittals:

Bidders will also be required to submit a digital version of the Unit Prices and Total Amount Bid. The excel spreadsheet is available through the LFUCG's Economic Engine website (<https://lfucg.economicengine.com>). If there is a discrepancy between the digital and written versions, then the written version shall prevail.

Base Bid Items

Item No.	Quantity	Unit to Bid On	Description	Unit Price	Total Amount Bid
1	66	LF	Remove curb _____ Dollars _____ Cents	\$ _____	\$ _____
2	411	SY	Remove concrete pavement _____ Dollars _____ Cents	\$ _____	\$ _____
3	198	SY	Install monolithic curb & concrete pavement - 4-1/2" _____ Dollars _____ Cents	\$ _____	\$ _____
4	223	SY	Install monolithic curb & concrete pavement - 6" _____ Dollars _____ Cents	\$ _____	\$ _____
5	20	SY	Install monolithic curb & concrete pavement - 12" _____ Dollars _____ Cents	\$ _____	\$ _____
6	27	TON	No. 2 stone _____ Dollars _____ Cents	\$ _____	\$ _____

7	97	TON	No. 57 stone _____ _____ Dollars _____ Cents	\$ _____	\$ _____
8	52	SY	Geotextile construction _____ _____ Dollars _____ Cents	\$ _____	\$ _____
9	43	LF	Stop Bar – 24" thermoplastic (<i>white</i>) _____ _____ Dollars _____ Cents	\$ _____	\$ _____
10	50	SF	ADA Detectable Warning surface (<i>yellow</i>) _____ _____ Dollars _____ Cents	\$ _____	\$ _____
11	1	LS	Pavement Striping Removal _____ _____ Dollars _____ Cents	\$ _____	\$ _____
12	1	LS	Maintain Traffic Control _____ _____ Dollars _____ Cents	\$ _____	\$ _____
13	1	LS	Erosion & Sediment Control _____ _____ Dollars _____ Cents	\$ _____	\$ _____
14	1400	LF	Conduit 2" Schedule 80 PVC _____ _____ Dollars _____ Cents	\$ _____	\$ _____
15	150	LF	Conduit 2" Schedule 80 HDPE _____ _____ Dollars _____ Cents	\$ _____	\$ _____
16	2	EA	Junction Box – Electrical Type A _____ _____ Dollars _____ Cents	\$ _____	\$ _____
17	3	EA	Junction Box – Electrical Type C _____ _____ Dollars _____ Cents	\$ _____	\$ _____

18	7400	LF	Cable No. 14/7C _____ _____ Dollars _____ Cents	\$ _____	\$ _____
19	2	EA	9' Pedestal Pole (spun aluminum) _____ _____ Dollars _____ Cents	\$ _____	\$ _____
20	1	EA	12' Pedestal Pole (Pelco PB-5201 or equiv.) _____ _____ Dollars _____ Cents	\$ _____	\$ _____
21	1	EA	22' Steel Pole _____ _____ Dollars _____ Cents	\$ _____	\$ _____
22	2	EA	30' Steel Pole _____ _____ Dollars _____ Cents	\$ _____	\$ _____
23	1	EA	35' Mast Arm _____ _____ Dollars _____ Cents	\$ _____	\$ _____
24	1	EA	40' Mast Arm _____ _____ Dollars _____ Cents	\$ _____	\$ _____
25	2	EA	43' Mast Arm _____ _____ Dollars _____ Cents	\$ _____	\$ _____
26	1	EA	45' Mast Arm _____ _____ Dollars _____ Cents	\$ _____	\$ _____
27	1	EA	70' Mast Arm _____ _____ Dollars _____ Cents	\$ _____	\$ _____
28	15	EA	Signal - 3 Section 12" _____ _____ Dollars _____ Cents	\$ _____	\$ _____

29	3	EA	Signal – 3 Section Arrow 12" _____ _____ Dollars _____ Cents	\$ _____	\$ _____
30	1	EA	Signal – 4 Section FYA 12" _____ _____ Dollars _____ Cents	\$ _____	\$ _____
31	6	EA	Signal – Pedestrian (Countdown) _____ _____ Dollars _____ Cents	\$ _____	\$ _____
32	6	EA	Pedestrian Detector w/ Sign R10-3e _____ _____ Dollars _____ Cents	\$ _____	\$ _____
33	1	EA	Electric Service w/ disconnect _____ _____ Dollars _____ Cents	\$ _____	\$ _____
34	1	EA	Mast Arm Dampener _____ _____ Dollars _____ Cents	\$ _____	\$ _____
35	12.6	CY	Traffic Signal Pole Base _____ _____ Dollars _____ Cents	\$ _____	\$ _____
36	1	LS	Remove Signal Equipment _____ _____ Dollars _____ Cents	\$ _____	\$ _____
37	4	EA	Street Sign (Non-illuminated) _____ _____ Dollars _____ Cents	\$ _____	\$ _____
38	1	EA	Fiber Optic Novice Kit _____ _____ Dollars _____ Cents	\$ _____	\$ _____
39	1	EA	Signal Controller – Type 2070L & Cabinet _____ _____ Dollars _____ Cents	\$ _____	\$ _____

40	1	LS	Mobilization (Max. 5%) _____ _____ Dollars _____ Cents	\$ _____	\$ _____
41	1	LS	Demobilization (Min. 1.5%) _____ _____ Dollars _____ Cents	\$ _____	\$ _____

Alternate 1 - Bid Items

Item No.	Quantity	Unit to Bid On	Description	Unit Price	Total Amount Bid
42	28	LF	Remove curb _____ _____ Dollars _____ Cents	\$ _____	\$ _____
43	32	SY	Remove concrete pavement _____ _____ Dollars _____ Cents	\$ _____	\$ _____
44	38	SY	Install monolithic curb & concrete pavement - 4-1/2" _____ _____ Dollars _____ Cents	\$ _____	\$ _____
45	9	TON	No. 57 Stone _____ _____ Dollars _____ Cents	\$ _____	\$ _____
46	424	LF	Enhanced Crosswalk – 12" thermoplastic (white) _____ _____ Dollars _____ Cents	\$ _____	\$ _____
47	1	LS	Mobilization (Max. 5%) _____ _____ Dollars _____ Cents	\$ _____	\$ _____
48	1	LS	Demobilization (Min. 1.5%) _____ _____ Dollars _____ Cents	\$ _____	\$ _____

Alternate 2 - Bid Items

Item No.	Quantity	Unit to Bid On	Description	Unit Price	Total Amount Bid
49	2	EA	Illuminated Street Sign _____ Dollars _____ Cents	\$ _____	\$ _____
50	1	LS	Mobilization (Max. 5%) _____ Dollars _____ Cents	\$ _____	\$ _____
51	1	LS	Demobilization (Min. 1.5%) _____ Dollars _____ Cents	\$ _____	\$ _____

****Alternates shall only be considered and added to the Base Bid provided funding is available. LPA reserves the right to add the unselected alternates should additional funding for the project become available.***

TOTAL OF BASE BID PRICES FOR Winchester Road, East Seventh Street, Liberty Road Intersection Improvements Project (Items 1 through 41) in figures.

 _____ (\$ _____).

TOTAL OF BASE BID & ALTERNATE 1 PRICES FOR Winchester Road, East Seventh Street, Liberty Road Intersection Improvements Project (Items 42 through 48) in figures.

 _____ (\$ _____).

TOTAL OF ALL BID PRICES FOR Winchester Road, East Seventh Street, Liberty Road Intersection Improvements Project (Items 49 through 51) in figures.

 _____ (\$ _____).

Submitted by:

Firm

Address

City, State & Zip

***Bid must be signed:
(original signature)***

Signature of Authorized Company Representative – Title

Representative/s Name (Typed or Printed)

Area Code – Phone – Fax #

E-Mail Address

OFFICIAL ADDRESS:

(Seal if Bid is by Corporation)

By signing this form you agree to ALL terms, conditions, and associated forms in this bid package

5. **STATEMENT OF BIDDER'S QUALIFICATIONS**

The following statement of the Bidder's qualifications is required to be filled in, executed, and submitted with the Proposal:

- 1. Name of Bidder: _____
- 2. Permanent Place of Business: _____
- 3. When Organized: _____
- 4. Where Incorporated: _____
- 5. Construction Plant and Equipment Available for this Project:

(Attach Separate Sheet If Necessary)

- 6. Financial Condition:

If specifically requested by the OWNER, the apparent low Bidder is required to submit its latest three (3) years audited financial statements to the OWNER'S Division of Central Purchasing within seven (7) calendar days following the bid opening.

- 7. In the event the Contract is awarded to the undersigned, surety bonds will be furnished by:

_____ (Surety)

Signed: _____ (Representative of Surety)

8. The following is a list of similar projects performed by the Bidder: (Attach separate sheet if necessary).

<u>NAME</u>	<u>LOCATION</u>	<u>CONTRACT SUM</u>
_____	_____	_____
_____	_____	_____
_____	_____	_____
_____	_____	_____
_____	_____	_____

9. The Bidder has now under contract and bonded the following projects:

<u>NAME</u>	<u>LOCATION</u>	<u>CONTRACT SUM</u>
_____	_____	_____
_____	_____	_____
_____	_____	_____
_____	_____	_____
_____	_____	_____

10. List Key Bidder Personnel who will work on this Project.

<u>NAME</u>	<u>POSITION DESCRIPTION</u>	<u>NO. OF YEARS WITH BIDDER</u>
_____	_____	_____
_____	_____	_____
_____	_____	_____
_____	_____	_____
_____	_____	_____

11. DBE Participation on current bonded projects under contract:

<u>SUBCONTRACTORS</u> <u>(LIST)</u>	<u>PROJECT</u> <u>(SPECIFIC TYPE)</u>	<u>DBE</u>	<u>% of WORK</u>
_____	_____	_____	_____
_____	_____	_____	_____
_____	_____	_____	_____
_____	_____	_____	_____
_____	_____	_____	_____
_____	_____	_____	_____
_____	_____	_____	_____
_____	_____	_____	_____
_____	_____	_____	_____
_____	_____	_____	_____

(USE ADDITIONAL SHEETS IF NECESSARY)

12. We acknowledge that, if we are the apparent low Bidder, we will submit to the OWNER within 7 calendar days following the Bid Opening, a sworn statement on the OWNER'S form regarding all current work on hand and under contract, and a statement on the OWNER'S form of the experience of our officers, office management and field management personnel. Additionally, if requested by the OWNER, we will within 7 days following the request submit audited financial statements and loss history for insurance claims for the 3 most recent years (or a lesser period stipulated by the OWNER)—all in accordance with the Bid Documents.

Respectfully submitted:

(Name of Contracting Firm)

BY: _____

TITLE: _____

DATE _____, 2014

6. LIST OF PROPOSED SUBCONTRACTORS

The following list of proposed subcontractors is required by the OWNER to be executed, completed and submitted with the BIDDER'S FORM OF PROPOSAL. All subcontractors are subject to approval of the Lexington-Fayette Urban County Government. Failure to submit this list completely filled out may be cause for rejection of bid.

<u>BRANCH OF WORK-LIST EACH</u> <u>MAJOR ITEM</u> Such as: Concrete, bituminous paving, concrete, pavement markings, construction staking, etc.	<u>SUBCONTRACTOR</u>	<u>DBE</u> <u>Yes/No</u>	<u>% of</u> <u>Work</u>
--	----------------------	-----------------------------	----------------------------

1. _____	Name: _____	_____	_____
	Address: _____		
2. _____	Name: _____	_____	_____
	Address: _____		
3. _____	Name: _____	_____	_____
	Address: _____		
4. _____	Name: _____	_____	_____
	Address: _____		
5. _____	Name: _____	_____	_____
	Address: _____		
6. _____	Name: _____	_____	_____
	Address: _____		
7. _____	Name: _____	_____	_____
	Address: _____		

(Attach additional sheet(s) if necessary.)

7. **LIST OF MATERIALS/ SUPPLIERS**

Bidders are hereby advised that this list must be complete and submitted with the Bid.

Listing "as per plans and specifications", will not be considered as sufficient identification. Where more than one "Make or Brand" is listed for any one item, the Owner has the right to select the one to be used.

Item	Brand Name, Manufacturer and/or Supplier
------	--

1. Concrete Supplier	<hr/>
----------------------	-------

END LIST OF MATERIALS AND EQUIPMENT

8. DBE SUB-CONTRACTOR BIDDERS LIST

The Department of Transportation Federal Regulations requires that the Kentucky Transportation Cabinet provide a bidders list to be maintained in the Office of Personnel Management, Small Business Development Branch (49CFR 26:11) for each federally funded project awarded.

Project No.

List all quotes/bids received on this project.

DBE (Disadvantaged Business Enterprise) Contractors, Consultants, and Suppliers submitting quotes/bids for this project:

- 1.
- 2.
- 3.
- 4.
- 5.
- 6.
- 7.
- 8.

DBE (Disadvantaged Business Enterprise) Contractors, Consultants, and Suppliers contacted who did NOT submit quotes/bids for this project.

- 1.
- 2.
- 3.
- 4.
- 5.
- 6.
- 7.
- 8.

Non-DBE (Disadvantaged Business Enterprise) Contractors, Consultants, and Suppliers submitting quotes/bids for this project:

- 1.
- 2.
- 3.
- 4.
- 5.
- 6.
- 7.
- 8.

If you need additional space, please attach a separate page. If you need assistance regarding this form, please contact Melvin Bynes or Anita Hall at (502)564-3601.

9. CERTIFICATION FOR FEDERAL-AID CONTRACT

The prospective participant certifies, by signing and submitting this bid or proposal, to the best of his or her knowledge and belief, that:

1. No Federal appropriated funds have been paid or will be paid, by or on behalf of the undersigned, to any person for influencing or attempting to influence an officer or employee of any Federal agency, a Member of Congress, an officer or employee of Congress, or an employee of a Member of Congress in connection with the awarding of any Federal contract, the making of any Federal grant, the making of any Federal loan, the entering into of any cooperative agreement, and the extension, continuation, renewal, amendment, or modification of any Federal contract, grant, loan, or cooperative agent.

2. If any funds other than the Federal appropriated funds have been paid or will be paid to any person for influencing or attempting to influence an officer or employee of any Federal agency, a Member of Congress, an officer or employee of Congress, or an employee of a Member of Congress in connection with this Federal contract, grant, loan, or cooperative agreement, the undersigned shall complete and submit Standard Form-LLL, "Disclosure Form to Report Lobbying," in accordance with its instructions.

- This certification is a material representation of fact which reliance was placed when this transaction was made or entered into. Submission of this certification is a prerequisite for making or entering into this transaction imposed by Section 1352, Title 31, U.S. Code. Any person who fails to file the required certification shall be subject to a civil penalty of not less than \$10,000 and not more than \$100,000 for each such failure.

The prospective participation also agrees by submitting his or her bid proposal that he or she shall require the language of this certification be included in all lower tier subcontracts, which exceed \$100,000 and that all such subrecipients shall certify and disclose accordingly.

(Name of Individual, Co-Partnership, or Corporation submitting bid)

(Printed Name of officer signing certification) (Title)

(Signature) (Date)

10. CERTIFICATION OF PERFORMANCE

Certification with regard to the Performance of Previous Contracts or Subcontracts subject to the Equal Opportunity Clause and the filing of Required Reports.

The _____, hereby certifies that he/she _____, participated in previous contract or subcontract subject to the equal opportunity clause, as required by Executive Orders 10925, 11114, or 11246, and that he, filed with the Joint Reporting committee, the Director of the Office of Federal Contract Compliance, a Federal Government contracting or administering agency, or the Former President's Committee on Equal Employment Opportunity, all reports due under the applicable filing requirements.

(Name of Individual, Co-Partnership, or Corporation submitting bid)

(Name of Officer or Authorized Agent)

(Title)

(Signature)

(Date)

NOTE: The above certification is required by the Equal Employment Opportunity Regulations of the Secretary of Labor (41 CFR 60-1.7 (b) (1)), and must be submitted by bidders and proposed subcontractors only in connection with the contracts and subcontracts which are subject to the equal opportunity clause. Contracts and subcontracts which are exempt from the equal opportunity clause are set forth in 41 CFR 60-1.5. (Generally only contracts or subcontracts of \$10,000 or under are exempt.)

Currently, Standard Form 100 (EE0-1) is the only report required by the Executive Orders of their implementing regulation.

Proposed prime contractors and subcontractors who have participated in a previous contract or subcontract subject to the Executive Orders and have not filed reports should note that 41 CFR 60-1.7 (b) (1) prevents the award of contracts and subcontracts unless such contractor submits a report covering the delinquent period or such other period specified by the Federal Highway Administration or by the Director or by the Director, Office of Federal Contract Compliance, U.S. Department of Labor.

11. CERTIFICATION OF ORGANIZATION(S)

COMMONWEALTH OF KENTUCKY

COUNTY: FAYETTE

FED PROJECT NO:

I, _____, _____
(Name of officer or Authorized Agent) (Title)

under penalty of perjury under the laws of the United States, do hereby certify that, except as noted below,

(Name of Individual, Co-Partnership, or Corporation submitting bid)

any person associated therewith in the capacity of (owner, partner, director, officer, principal investigator, project director, manager, auditor, or any position involving the Administration of Federal Funds): is not currently under suspension, debarment, voluntarily exclusion, or determination of ineligibility by any federal agency; has not been suspended, debarred, voluntarily excluded or determined ineligible by any federal agency within the past 3 years; does not have a proposed debarment pending; and has not been indicted, convicted, or had a civil judgment rendered against (it) by a court of competent jurisdiction in any matter involving fraud or official misconduct within the past 3 years.

Please list below any exceptions to the foregoing, to whom it applies, initiating agency and dates of action.

Exceptions:

(Name of Individual, Co-Partnership, or Corporation submitting bid)

(Name of Officer or Authorized Agent) (Title)

(Signature) (Date)

12. CERTIFICATION OF BID PROPOSAL/DBE

We (I) proposed to furnish all labor, equipment and material necessary to construct and/or improve the subject project in accordance with the plans, the Transportation Cabinet's Standard Specifications for Road and Bridge Construction, current edition, special provisions, notes applicable to the project as indicated herein and all addenda issued on this project subsequent to purchase of proposal.

We (I) attach a bid guaranty as provided in the special provisions in an amount not less than 5% of the total bid. We agree to execute a contract in accordance with this proposal within 15 calendar days after the receipt of the notice of award for the project.

We (I) have examined the site of proposed work, project plans, specifications, special provisions, and notes applicable to the project referred to herein. We understand that the quantities shown herein are estimated quantities subject increase or decrease as provided in the specifications.

We (I) acknowledge receipt of all addendum(s) (if applicable) and have made necessary revisions to the bid proposal. We have considered all addendum(s) in calculation of the submitted bid and applied the updated bid items, which are included.

"The bidder certifies that it has secured participation by Disadvantaged Business Enterprises (DBE) in amount of [REDACTED] percent ([REDACTED]%) of the total value of this contract and that the DBE participation is in compliance with the requirements of 49 CFR 26 and the policies of the Kentucky Transportation Cabinet pertaining to the DBE Program."

(Name of Individual, Co-Partnership, or Corporation submitting bid)

(Name of Officer or Authorized Agent) (Title)

(Signature) (Date)

When two or more organizations bid as a joint venture, enter names of each organization and an authorized agent for each organization must sign above.

13. KENTUCKY TRANSPORTATION CABINET – DBE PROVISIONS

KENTUCKY TRANSPORTATION CABINET – DISADVANTAGED BUSINESS ENTERPRISE PROVISIONS

SECOND TIER SUBCONTRACTS

Second Tier subcontracts on federally assisted projects shall be permitted. However, in the case of DBE's, second tier subcontracts will only be permitted where the other subcontractor is also a DBE. All second tier subcontracts shall have the consent of both the Contractor and the Engineer.

DISADVANTAGED BUSINESS ENTERPRISE PROGRAM

It is the policy of the Lexington-Fayette Urban County Government ("LFUCG") that Disadvantaged Business Enterprises ("DBE") shall have the opportunity to participate in the performance of highway construction projects financed in whole or in part by Federal Funds in order to create a level playing field for all businesses who wish to contract with the LFUCG. To that end, the LFUCG will comply with the regulations found in 49 CFR Part 26, and the definitions and requirements contained therein shall be adopted as if set out verbatim herein.

The LFUCG, contractors, subcontractors, and sub-recipients shall not discriminate on the basis of race, color, national origin, or sex in the performance of work performed pursuant to LFUCG contracts. The contractor shall carry out applicable requirements of 49 CFR 26 in the award and administration of federally assisted highway construction projects. The contractor will include this provision in all its subcontracts and supply agreements pertaining to contracts with the LFUCG.

Failure by the contractor to carry out these requirements is a material breach of its contract with the LFUCG, which may result in the termination of the contract or such other remedy as the LFUCG deems necessary.

DBE GOAL

The Disadvantaged Business Enterprise (DBE) goal established for this contract by the Kentucky Transportation Cabinet is a three percent (3 %) goal of the total value of the contract.

The contractor shall exercise all necessary and reasonable steps to ensure that Disadvantaged Business Enterprises participate in a least the percent of the contract as set forth above as goals for this contract.

OBLIGATION OF CONTRACTORS

If a formal goal has not been designated for the contract, all contractors are expected to meet LFUCG 10% MWDBE goal, unless otherwise stated. Contractor shall also consider DBEs for subcontract work as well as for the supply of material and services needed to perform this work.

Contractors are encouraged to use the services of banks owned and controlled by minorities and women.

CERTIFICATION OF CONTRACT GOAL

Contractors shall include the following certification in bids for projects for which a DBE goal has been established. BIDS SUBMITTED WHICH DO NOT INCLUDE CERTIFICATION OF DBE PARTICIPATION WILL NOT BE ACCEPTED. These bids will not be considered for award by the LFUCG and they will be returned to the bidder.

"The bidder certifies that it has secured participation by Disadvantaged Business Enterprises ("DBE") in the amount of KYTC **three percent (3)** of the total value of this contract and that the DBE participation is in compliance with the requirements of 49 CFR 26 and the policies of the Lexington-Fayette Urban County Government related to participation and **Kentucky Transportation Cabinet** pertaining to the DBE Program."

DBEs utilized in achieving the DBE goal must be certified and pre-qualified for the work items at the time the bid is submitted.

DBE PARTICIPATION PLAN

Lowest responsive bidders must submit the *DBE Plan/ Subcontractor Request*, form TC 63-35 DBE, within 7 days of the letting. This is necessary before the LFUCG Division of Central Purchasing will review and make a recommendation. The project will not be considered for award prior to submission and approval of the apparent low bidder's DBE Plan/Subcontractor Request.

The DBE Participation Plan shall include the following:

- 1 Name and address of DBE Subcontractor(s) and/or supplier(s) intended to be used in the proposed project;
- 2 Description of the work each is to perform including the work item, unit, quantity, unit price and total amount of the work to be performed by the individual DBE and the project bid number.
- 3 The dollar value of each proposed DBE subcontract and the percentage of total project contract value this represents. DBE participation may be counted as follows:
 - a) If DBE suppliers and manufactures assume actual and contractual responsibility, the dollar value of materials to be furnished will be counted toward the goal as follows:
 - The entire expenditure paid to a DBE manufacturer;
 - 60 percent of expenditures to DBE suppliers that are not manufacturers provided the supplier is a regular dealer in the product involved. A regular dealer must be engaged in, as its principal business and in its own name, the sale of products to the public, maintain an inventory and own and operate distribution equipment; and
 - The amount of fees or commissions charged by the DBE firms for a bona fide service, such as professional, technical, consultant, or managerial services and assistance in the procurement of essential personnel, facilities, equipment, materials, supplies, delivery of materials and supplies or for furnishing bonds, or insurance, providing such fees or commissions are determined to be reasonable and customary.
 - b) The dollar value of services provided by DBEs such as quality control testing, equipment repair and maintenance, engineering, staking, etc;
 - c) The dollar value of joint ventures. DBE credit for joint ventures will be limited to the dollar amount of the work actually performed by the DBE in the joint venture;
- 4 Written and signed documentation of the bidder's commitment to use a DBE contractor whose participation is being utilized to meet the DBE goal; and
- 5 Written and signed confirmation from the DBE that it is participating in the contract as provided in the prime contractor's commitment.

UPON AWARD AND BEFORE A WORK ORDER WILL BE ISSUED

Contractors must submit the signed subcontract between the contractor and the DBE contractor, the DBE's certificate of insurance, and the Required Affidavit of Bidders, Offerors, and Contractors from the DBE to the LFUCG Division of Central Purchasing. The Required Affidavit of Bidders, Offerors and Contractors is included with these bid documents and should be returned with your bid. If the DBE is a supplier of materials for the project, a signed purchase order and a Required Affidavit for Bidders, Offerors, and Contractors must be submitted to the LFUCG Division of Central Purchasing.

Changes to DBE Participation Plans or DBE substitutions must be approved by the LFUCG Division of Central Purchasing. The LFUCG may consider extenuating circumstances including, but not limited to, changes in the nature or scope of the project, the inability or unwillingness of a DBE to perform the work in accordance with the bid, and/or other circumstances beyond the control of the prime contractor.

CONSIDERATION OF GOOD FAITH EFFORTS REQUESTS

If the DBE participation submitted in the bid by the apparent lowest responsive bidder does not meet or exceed the DBE contract goal, the apparent lowest responsive bidder must submit a Good Faith Effort documentation to satisfy the LFUCG that sufficient good faith efforts were made to meet the contract goals prior to submission of the bid. Efforts to increase the goal after bid submission will not be considered in justifying the good faith effort, unless the contractor can show that the proposed DBE was solicited prior to the bid date. DBEs utilized in achieving the DBE goal must be certified and pre-qualified for the work items at the time the bid is submitted. One complete set of this information must be received in the office of the LFUCG Division of Central Purchasing no later than 12:00 noon of the tenth calendar day after receipt of notification that they are the apparent low bidder.

Where the information submitted includes repetitious solicitation letters it will be acceptable to submit a sample representative letter along with a distribution list of the firms solicited. Documentation of DBE quotations shall be a part of the good faith effort submittal as necessary to demonstrate compliance with the factors listed below which the LFUCG considers in judging good faith efforts. This documentation may include written subcontractors' quotations, telephone log notations of verbal quotations, or other types of quotation documentation.

The Good Faith Efforts documentation shall include, but may not be limited to information showing evidence of the following:

- 1 Whether the bidder attended any pre-bid meetings that were scheduled by LFUCG to inform DBEs of subcontracting opportunities;
- 2 Whether the bidder provided solicitations through all reasonable and available means;
- 3 Whether the bidder provided written notice to all DBEs listed in the DBE directory at the time of the letting that are pre-qualified in the areas of work that the bidder will be subcontracting;
- 4 Whether the bidder followed up initial solicitations of interest by contacting DBEs to determine with certainty whether they were interested. If a reasonable amount of DBEs within the targeted districts do not provide an intent to quote or no DBEs are pre-qualified in the subcontracted areas, the bidder must notify the Minority Business Enterprise Liaison in the Division of Central Purchasing to give notification of the bidder's inability to get DBE quotes;
- 5 Whether the bidder selected portions of the work to be performed by DBEs in order to increase the likelihood of meeting the contract goals. This includes, where appropriate, breaking out contract work items into economically feasible units to facilitate DBE participation, even when the prime contractor might otherwise perform these work items with its own forces;
- 6 Whether the bidder provided interested DBEs with adequate and timely information about the plans, specifications, and requirements of the contract;
- 7 Whether the bidder negotiated in good faith with interested DBEs not rejecting them as unqualified without sound reasons based on a thorough investigation of their capabilities. Any rejection should be so noted in writing with a description as to why an agreement could not be reached;
- 8 Whether quotations were received from interested DBE firms but were rejected as unacceptable without sound reasons why the quotations were considered unacceptable. The fact that the DBE firm's quotation for the work is not the lowest quotation received will not in itself be considered as a sound reason for rejecting the quotation as unacceptable. The fact that the bidder has the ability and/or desire to perform the contract work with its own forces will not be considered a sound reason for rejecting a DBE quote. Nothing in this provision shall be construed to require the bidder to accept unreasonable quotes in order to satisfy DBE goals;
- 9 Whether the bidder specifically negotiated with subcontractors to assume part of the responsibility to meet the contract DBE goal when the work to be subcontracted includes potential DBE participation;
- 10 Whether the bidder made any efforts and/or offered assistance to interested DBEs in obtaining the necessary equipment, supplies, materials, insurance and/or bonding to satisfy the work requirements of the bid proposal; and
- 11 Any other evidence that the bidder submits which may show that the bidder has made reasonable good faith efforts to include DBE participation.

FAILURE TO MEET GOOD FAITH REQUIREMENT

Where the apparent lowest responsive bidder fails to submit sufficient participation by DBE firms to meet the contract goal and upon a determination by the LFUCG Division of Central Purchasing based upon the information submitted that the apparent lowest responsive bidder failed to make sufficient reasonable efforts to meet the contract goal, the bidder will be offered the opportunity to meet in person with representatives from the Division of Central Purchasing. The bidder will be notified of the Division of Central Purchasing's decision within 24 hours of its decision. The bidder will have 24 hours to request reconsideration of Central Purchasing's decision. The reconsideration meeting will be held within two days of the receipt of a request by the bidder for reconsideration.

The request for reconsideration will be heard by Central Purchasing. The bidder will have the opportunity to present written documentation or argument concerning the issue of whether it met the goal or made an adequate good faith effort. The bidder will receive a written decision on the reconsideration explaining the basis for the finding that the bidder did or did not meet the goal or made adequate Good Faith efforts to do so.

The result of the reconsideration process is not administratively appealable to the LFUCG Division of Central Purchasing.

The LFUCG Division of Central Purchasing reserves the right to award the contract to the next lowest responsive bidder or to rebid the contract in the event that the contract is not awarded to the low bidder as the result of a failure to meet the good faith requirement.

SANCTIONS FOR FAILURE TO MEET DBE REQUIREMENTS OF THE PROJECT

Failure by the prime contractor to fulfill the DBE requirements of a project under contract or to demonstrate good faith efforts to meet the goal constitutes a breach of contract. When this occurs, the Cabinet will hold the prime contractor accountable, as would be the case with all other contract provisions. Therefore, the contractor's failure to carry out the DBE contract requirements shall constitute a breach of contract and as such the Cabinet reserves the right to exercise all administrative remedies at its disposal including, but not limited to the following:

- **Disallow credit toward the DBE goal;**
- **Withholding progress payments;**
- **Withholding payment to the prime in an amount equal to the unmet portion of the contract goal; and/or**
- **Termination of the contract.**

PROMPT PAYMENT

- **The prime contractor will be required to pay the DBE within seven (7) working days after he or she has received payment from the LFUCG Division of Central Purchasing for work performed or materials furnished**

CONTRACTOR REPORTING All Contractors must report on their progress in meeting the DBE requirement on any construction contracts. These records may include, but shall not be limited to payroll, lease agreements, cancelled payroll checks, executed subcontracting agreements, etc. Prime contractors will be required to submit certified reports on monies paid to each DBE subcontractor or supplier utilized to meet a DBE goal.

Payment information that needs to be reported includes date the payment is sent to the DBE, check number, Contract ID, amount of payment and the check date. Before Final Payment is made on this contract, the Prime Contractor will certify that all payments were made to the DBE subcontractor and/or DBE suppliers and show the documented proof.

The Prime Contractor should supply the payment information at the time the DBE is compensated for their work. Form to use is located at:

<http://transportation.ky.gov/Construction/Pages/Subcontracts.aspx>

Photocopied payments and completed form to be submitted to:

**Office of Civil Rights and Small
Business Development 6th Floor
West 200 Mero Street Frankfort, KY 40622**

DEFAULT OR DECERTIFICATION OF THE DBE

If the DBE subcontractor or supplier is decertified or defaults in the performance of its work, and the overall goal cannot be credited for the uncompleted work, the prime contractor may utilize a substitute DBE or elect to fulfill the DBE goal with another DBE on a different work item. If after exerting good faith effort in accordance with the LFUCG Division of Central Purchasing policies and procedures, the prime contractor is unable to replace the DBE, then the unmet portion of the goal may be waived at the discretion of the LFUCG Division of Central Purchasing.

END OF SECTION

**KENTUCKY TRANSPORTATION CABINET
DEPARTMENT OF HIGHWAYS
DIVISION OF CONSTRUCTION PROCUREMENT
DBE Plan/SUBCONTRACT REQUEST**

CONTRACT ID (CONTID) _____

Subcontract #: _____

TO: _____

Rachel Mills, Director

Division of Construction Procurement

FROM: _____

Prime Contractor

SUBJECT: _____

1st Tier Subcontractor:

(If applicable)

Project Number

I hereby request to utilize for DBE participation a portion of the subject project to:

_____ of _____

_____ of Federal DBE _____

DBE Employer Identification Numbers:

The amount to be subcontracted by this request is _____

(original contract) or a subcontract amount of _____

_____ KY

_____ or _____

_____ Contract

_____ Worth

_____ of the

I have previously requested approval for subcontracts or agreements with other DBE as follows:

Name of DBE firm

DBE Amount

DBE %

Contract "Worth"

Contract %

Totals based on original contract amounts

This section applicable if DBE firm is also a Subcontractor of work on Project:

This subcontractor has been furnished a copy of Appendix B of 49 CFR Part 29 and advised to include the Certification in all lower tier covered transactions and in all solicitations for lower tier transactions (Federal Aid Contracts only).

Prime Contractor's Signature

Date

1st Tier Subcontractor's Signature (if applicable)

Date

DBE Participant Signature

Date

**KENTUCKY TRANSPORTATION CABINET
DEPARTMENT OF HIGHWAYS
DIVISION OF CONSTRUCTION PROCUREMENT
DBE Plan/SUBCONTRACT REQUEST**

TC 14-35
Rev. 07/07/16
Page 3 of 3

Contract ID (ContID) _____ DBE Firm _____

(*) When description is limited by such as "Laying Only" "Erection Only" "Manipulation Only" etc, it should be so indicated and explained.

(**) When the quantity is not the entire amount of (Contract) or (Sub-Contract) estimate, limitations by stations must be shown or definitely designated in some suitable, positive manner.

Unit prices using Contract "worth" Unit Price should be for Bid Unit Price for work to be performed by Sub Contractor. If partial work item is "laying only" then use agreed to price for Contract "worth" Unit Price. DBE Unit price should be for the agreed upon price for item or portion of item of contract work.

The items to be subcontracted are as follows:

Supplier SPX /W	Project Control (PCN) Number	Category Number	Project Line Number	Description	Unit	Contract Quantity	Contract "Worth" Unit Price	Dollar Amount based on Contract Price	DBE Quantity	DBE Unit Price	Dollar Amount based on DBE Price
Comments:								Page Total			

14. NON-COLLUSION CERTIFICATION

COMMONWEALTH OF KENTUCKY

COUNTY: FAYETTE

FED PROJECT NO:

I, _____, _____,
(Name of officer or Authorized Agent) (Title)

under penalty of perjury under the laws of the United States, do hereby certify that

(Name of Individual, Co-Partnership, or Corporation submitting bid)

Its agent, officers or employees have not directly or indirectly entered into any agreement, participated in any collusion, or otherwise taken action in restraint of free competitive bidding in connection with this proposal.

(Name of Officer or Authorized Agent) (Title)

(Signature) (Date)

15. STATEMENT OF EXPERIENCE

NAME OF INDIVIDUAL: _____

POSITION/TITLE: _____

STATEMENT OF EXPERIENCE: _____

NAME OF INDIVIDUAL: _____

POSITION/TITLE: _____

STATEMENT OF EXPERIENCE: _____

NAME OF INDIVIDUAL: _____

POSITION/TITLE: _____

STATEMENT OF EXPERIENCE: _____

NAME OF INDIVIDUAL: _____

POSITION/TITLE: _____

STATEMENT OF EXPERIENCE: _____

NAME OF INDIVIDUAL: _____

POSITION/TITLE: _____

STATEMENT OF EXPERIENCE: _____

NAME OF INDIVIDUAL: _____

POSITION/TITLE: _____

STATEMENT OF EXPERIENCE: _____

*** Include all officers, office management's, Affirmative Action officials, and field management personnel. (Attach separate sheets if necessary.)**

16. EQUAL OPPORTUNITY AGREEMENT

The Law

* Standard Title VI Assurance

The Lexington Fayette-Urban County Government, (hereinafter referred to as the "Recipient") hereby agrees that as a condition to receiving any Federal financial assistance from the U.S. Department of Transportation, it will comply with Title VI of the Civil Rights Act of 1964, 78Stat.252, 42 U.S.C. 2000d-4 (hereinafter referred to as the "Act"), and all requirements imposed by or pursuant to Title 49, Code of Federal Regulations, U.S. Department of Transportation, Subtitle A, Office of the Secretary, (49 CFR, Part 21) Nondiscrimination in Federally Assisted Program of the Department of Transportation – Effectuation of Title VI of the Civil Rights Act of 1964 (hereinafter referred to as the "Regulations") and other pertinent directives, no person in the United States shall, on the grounds of race, color, national origin, sex, age (over 40), religion, sexual orientation, gender identity, veteran status, or disability be excluded from participation in, be denied the benefits of, or be otherwise subjected to discrimination under any program or activity for which the Recipient receives Federal financial assistance from the U.S. Department of Transportation, including the Federal Highway Administration, and hereby gives assurance that will promptly take any necessary measures to effectuate this agreement. This assurance is required by subsection 21.7(a) (1) of the Regulations.

- * Title VII of the Civil Rights Act of 1964 (amended 1972) states that it is unlawful for an employer to discriminate in employment because of race, color, religion, sex, age (40-70 years) or national origin.
- * Executive Order No. 11246 on Nondiscrimination under Federal contract prohibits employment discrimination by contractor and subcontractor doing business with the Federal Government or recipients of Federal funds. This order was later amended by Executive Order No. 11375 to prohibit discrimination on the basis of sex.
- * Section 503 of the Rehabilitation Act of 1973 States:

The Contractor will not discriminate against any employee or applicant for employment because of physical or mental handicap.
- * Section 2012 of the Vietnam Era Veterans Readjustment Act of 1973 requires Affirmative Action on behalf of disabled veterans and veterans of the Vietnam Era by contractors having Federal Contracts.
- * Section 206 (A) of Executive Order 12086, Consolidation of Contract Compliance Functions for Equal Employment Opportunity, states:

The Secretary of Labor may investigate the employment practices of any Government contractor or sub-contractor to determine whether or not the contractual provisions specified in Section 202 of this order have been violated.

The Lexington-Fayette Urban County Government practices Equal Opportunity in recruiting, hiring and promoting. It is the Government's intent to affirmatively provide employment opportunities for those individuals who have previously not been allowed to enter into the mainstream of society. Because of its importance to the local Government, this policy carries the full endorsement of the Mayor, Commissioners, Directors, and all supervisory personnel. In following this commitment to Equal Employment Opportunity and because the Government is the benefactor of the Federal funds, it is both against the Urban County Government policy and illegal for the Government to let contracts to companies which knowingly or unknowingly practice discrimination in their employment practices. Violation of the above mentioned ordinances may cause a contract to be canceled and the contractor may be declared ineligible for future consideration.

Please sign this statement in the appropriate space acknowledging that you have read and understand the provisions contained herein. Return this document as part of your application packet.

Bidders

I/We agree to comply with the Civil Rights Laws listed above that govern employment rights of minorities, women, Vietnam veterans, handicapped, and aged persons.

Signature

Name of Business

The Entity (regardless of whether construction contractor, non-construction contractor or supplier) agrees to provide equal opportunity in employment for all qualified persons, to prohibit discrimination in employment because of race, color, creed, national origin, sex or age, and to promote equal employment through a positive, continuing program from itself and each of its sub-contracting agents. This program of equal employment opportunity shall apply to every aspect of its employment policies and practices.

The Kentucky equal Employment Opportunity Act of 1978 (KRS 45.560-45.640) requires that any count, city, town, school district, water district, hospital district, or other political subdivision of the state shall include in directly or indirectly publicly funded contracts for supplies, materials, services, or equipment hereinafter entered into the following provisions:

During the performance of this contract, the contractor agrees as follows:

- (1) *The contractor will not discriminate against any employee or applicant for employment because of race, color, religion, sex, age or national origin;*
- (2) *The contractor will state in all solicitations or advertisements for employees placed by or on behalf of the contractors that all qualified applicants will receive consideration for employment without regard to race, color, religion, sex, age or national origin;*
- (3) *The contract will post notices in conspicuous places, available to employees and applicants for employment, setting forth the provisions of the non-discrimination clauses required by this section; and*

- (4) *The contractor will send a notice to each labor union or representative of workers with which he has a collective bargaining agreement or other contract or understanding advising the labor union or workers' representative of the contractor's commitments under the nondiscrimination clauses.*

The Act further provides:

KRS 45.610. Hiring minorities – Information required

- (1) *For the length of the contract, each contractor shall hire minorities from other sources within the drawing area, should the union with which he has collective bargaining agreements be unwilling to supply sufficient minorities to satisfy the agreed upon goals and timetable.*
- (2) *Each contractor shall, for the length of the contract, furnish such information as required by KRS 45.560 to KRS 45.640 and by such rules, regulations and orders issued pursuant thereto and will permit access to all books and records pertaining to his employment practices and work sites by the contracting agency and the department for purposes of investigation to ascertain compliance with KRS 45.560 to 45.640 and such rules, regulations and orders issued pursuant thereto.*

KRS 45.620. Action against contractor – Hiring of minority contractor or subcontractor

- (1) *If any contractor is found by the department to have engaged in an unlawful practice under this chapter during the course of performing under a contract or subcontract covered under KRS 45.560 to 45.640, the department shall so certify to the contracting agency and such certification shall be binding upon the contracting agency unless it is reversed in the course of judicial review.*
- (2) *If the contractor is found to have committed an unlawful practice under KRS 45.560 to 45.640, the contracting agency may cancel or terminate the contract, conditioned upon a program for future compliance approved by the contracting agency and the department. The contracting agency may declare such a contractor ineligible to bid on further contracts with that agency until such time as the contractor complies in full with the requirements of KRS 45.560 – 45.640.*
- (3) *The equal employment provisions of KRS 45.560 to 45.640 may be met in part by a contractor by subcontracting to a minority contractor or subcontractor. For the provisions of KRS 45.560 to 45.640, a minority contractor or subcontractor shall mean a business that is owned and controlled by one or more persons disadvantaged by racial or ethnic circumstances.*

KRS 45.630 Termination of existing employee not required, when

Any provision of KRS 45.560 to 45.640 notwithstanding, no contractor shall be required to terminate an existing employee upon proof that that employee was employed prior to the date of the contract.

KRS 45.640 Minimum skills

Nothing in KRS 45.560 to 45.640 shall require a contractor to hire anyone who fails to demonstrate the minimum skills required to perform a particular job.

It is recommended that all of the provisions quoted above to be included as special conditions in each contract. In the case of a contract exceeding \$250,000, the contractor is required to furnish evidence that his work-force in Kentucky is representative of the available work-force in the area from which he draws employees, or to supply an Affirmative Action plan which will achieve such representation during the life of the contract.

17. EQUAL EMPLOYMENT OPPORTUNITY AFFIRMATIVE ACTION POLICY

It is the policy of _____
to assure that all applicants for employment and all employees are treated on a fair and equitable basis without regard to their race, religion, sex, color, handicap, natural origin or age.

Such action shall include employment, promotion, demotion, recruitment or recruitment advertising, layoff or termination, rates of pay and other forms of compensation, and selection for training, whether apprenticeship and/or on-the-job-training.

Furthermore, this company agrees to make special recruitment efforts to hire the protected class whenever feasible. This company also agrees to adhere to all applicable federal, state, and local laws relating to Equal Employment Opportunity for all individuals.

_____ has been appointed Equal Employment Compliance (EEOC) Officer and shall be available for counseling, answering of questions in regards to this company policy, and to hear any complaints of discrimination. The EEOC Officer may be reached by calling _____.

Signature: _____
(Bidding Contractor)

Title: _____

Date: _____

18. WORKFORCE ANALYSIS FORM

Name of Organization: _____

Categories	Total	White (Not Hispanic or Latino)		Hispanic or Latino		Black or African-American (Not Hispanic or Latino)		Native Hawaiian and Other Pacific Islander (Not Hispanic)		Asian (Not Hispanic or Latino)		American Indian or Alaskan Native (not Hispanic or Latino)		Two or more races (Not Hispanic or Latino)		Total	
		M	F	M	F	M	F	M	F	M	F	M	F	M	F	M	F
Administrators																	
Professionals																	
Superintendents																	
Supervisors																	
Foremen																	
Technicians																	
Protective Service																	
Para-Professionals																	
Office/Clerical																	
Skilled Craft																	
Service/Maintenance																	
Total:																	

Prepared by: _____

(Name and Title)

Date: ____ / ____ / ____

Revised 2015-Dec-15

19. EVIDENCE OF INSURABILITY

LEXINGTON-FAYETTE URBAN COUNTY GOVERNMENT CONSTRUCTION PROJECT
 (Use separate form for each Agency or Brokerage agreeing to provide coverage)

Names Insured: _____ Employee ID: _____
 Address: _____ Phone: _____

Project to be insured: _____

In lieu of obtaining certificates of insurance at this time, the undersigned agrees to provide the above Named Insured with the minimum coverage listed below. These are outlined in the Insurance and Risk Management of Part V (Special Conditions), including all requirements, and conditions:

Section Items	Coverage	Minimum Limits and Policy Requirements	Limits Provided To Insured	Name of Insurer	A.M. Best's Code	Rating
SC-3, Section 2, Part 4.1 - see provisions	CGL	\$1,000,000 per occ. And \$2,000,000 aggregate	\$			
SC-3, Section 2, Part 4.1 - see provisions	AUTO	\$2,000,000/per occ.	\$			
SC-3, Section 2, Part 4.1 - see provisions	WC	Statutory w /endorsement as noted	\$			

Section 2 includes required provisions, statements regarding insurance requirements, and the undersigned agrees to abide by all provisions for the coverage's checked above unless stated otherwise when submitting.

Agency or Brokerage _____ Name of Authorized Representative _____

Street Address _____ Title _____

City _____ State _____ Zip _____ Authorized Signature _____

Telephone Number _____ Date _____

NOTE: Authorized signatures may be the agent's if agent has placed insurance through an agency agreement with the insurer. If insurance is brokered, authorized signature must be that of authorized representative of insurer.

20. DEBARRED FIRMS

PROJECT NAME: _____

BID NUMBER: _____

**LEXINGTON-FAYETTE URBAN COUNTY GOVERNMENT
LEXINGTON, KY**

All prime Contractors shall certify that Subcontractors have not and will not be awarded to any firms that has been debarred for noncompliance with the Federal Labor Standards, Title VI of the **Civil Rights Act of 1964 As Amended, Executive Order 11246 As Amended** or any other Federal Law.

All bidders shall complete the attached certification in duplicate and submit both copies to the Owner with the bid proposal. The Owner (grantee) shall transmit one copy to the Lexington-Fayette Urban County Government, Division of Community Development, within fourteen (14) days after bid opening.

The undersigned hereby certifies that the firm of _____ has not and will not award a subcontract, in connection with any contract award to it as the result of this bid, to any firm that has been debarred for noncompliance with the Federal labor Standards, Title VI of the Civil Rights Act of 1964, Executive Order 11246 as amended or any Federal Law.

Name of Firm Submitting Bid

Signature of Authorized Official

Title

Date

21. DEBARMENT CERTIFICATION

All contractors/subcontractors shall complete the following certification and submit it with the bid proposal.

The contractor/subcontractor certifies in accordance with Executive Order 12549 (Debarment and Suspension 2/18/86) that to the best of its knowledge and belief, that it and its principals:

- 1) Are not presently debarred, suspended, proposed for debarment, declared negligible, or voluntarily excluded from covered transactions or contract by any Federal department or agency for noncompliance with the Federal Labor Standards, Title VI of the Civil Rights Act of 1964 as amended, Executive Order 11246 as amended or any other Federal law;
 - a) Have not within a three year period preceding this proposal been convicted of or had a civil judgment rendered against them for commission of fraud or a criminal offense in connection with obtaining, attempting to obtain, or performing a public (Federal, State or local) transaction or contract under a public transaction; violation of Federal or State antitrust statutes or commission of embezzlement, theft, forgery, bribery, falsification or destruction of records, making false statements, or receiving stolen property;
 - b) Are not presently indicted for or otherwise criminally or civilly charged by a government entity (Federal, State or local) with commission of any of the offenses enumerated in paragraph (1)(a) of this certification; and
 - c) Have not within a three year period preceding this bid has one or more public (Federal, State or local) transactions or contracts terminated for cause or default.
- 2) Where the contractor is unable to certify to any of the statements in this certification, such prospective contractors shall attach an explanation to this certification form.

Firm Name: _____

Project: _____

Printed Name and Title of Authorized Representative: _____

Signature: _____

Date: _____

22. PROVISIONS RELATIVE TO SENATE BILL 45A-485

During the performance of the contract, the contractor agrees to comply with the applicable provisions of:

1. KRS 136 Corporation and Utility Tax
2. KRS 139 Sales and Use Taxes
3. KRS 141 Income Taxes
4. KRS 337 Wages and Hours
5. KRS 338 Occupational Safety and Health of Employees
6. KRS 341 Unemployment Compensation
7. KRS 342 Workers Compensation

Any final determinations of a violation by the contractor within the previous (5) years pursuant to the applicable statutes above are revealed as follows:

23. EXECUTIVE BRANCH CODE OF ETHICS

In the 1992 regular legislative session, the General Assembly passed and Governor Brereton Jones signed Senate Bill 63 (codified as KRS 11A), the Executive Branch Code of Ethics, which states, in part:

KRS 11A.040 (7) provides:

No present or former public servant shall, within six (6) months of following termination of his office or employment, accept employment, compensation or other economic benefit from any person or business that contracts or does business with, or is regulated by, the state in matters in which he was directly involved during the last thirty-six (36) months of his tenure. This provision shall not prohibit an individual from returning to the same business, firm, occupation, or profession in which he was involved prior to taking office or beginning his term of employment, or for which he received, prior to his state employment, a professional degree or license, provided that, for a period of six (6) months, he personally refrains from working on any matter in which he was directly involved during the last thirty-six (36) months of his tenure in state government. This subsection shall not prohibit the performance of ministerial functions, including, but not limited to, filing tax returns, filing applications for permits or licenses, or filing incorporation papers, nor shall it prohibit the former officer or public servant from receiving public funds disbursed through entitlement programs.

KRS 11A.040 (9) states:

A former public servant shall not represent a person or business before a state agency in a matter in which the former public servant was directly involved during the last thirty-six (36) months of his tenure, for a period of one (1) year after the latter of:

- a) The date of leaving office or termination of employment; or
- b) The date the term of office expires to which the public servant was elected.

This law is intended to promote public confidence in the integrity of state government and to declare as public policy the idea that state employees should view their work as a public trust and not as a way to obtain private benefits.

If you have worked for the executive branch of state government within the past six months, you may be subject to the law's prohibitions. The law's applicability may be different if you hold elected office or are contemplating representation of another before a state agency.

Also, if you are affiliated with a firm which does business with the state and which employs former state executive-branch employees, you should be aware that the law may apply to them.

In case of doubt, the law permits you to request an advisory opinion from the Executive Branch Ethics Commission, 3 Fountain Place, Frankfort, Kentucky 40601; telephone (502) 564-7954.

Signature of Authorized Official

Title

Date

END OF SECTION



PART IV
GENERAL CONDITIONS
TABLE OF CONTENTS

Article Number	Title	Page
1.	DEFINITIONS	GC-6
2.	PRELIMINARY MATTERS.....	GC-10
3.	CONTRACT DOCUMENTS: INTENT, CONFLICTS, AMENDING AND REUSE	GC-11
4.	AVAILABILITY OF LANDS; PHYSICAL CONDITIONS; REFERENCE POINTS.....	GC-13
5.	CONTRACTOR'S RESPONSIBILITIES	GC-16
6.	OTHER WORK	GC-27
7.	OWNER'S RESPONSIBILITIES	GC-28
8.	CONSULTANT'S STATUS DURING CONSTRUCTION	GC-28
9.	CHANGES IN THE WORK	GC-31
10.	CHANGE OF CONTRACT PRICE.....	GC-32
11.	CHANGE OF CONTRACT TIME	GC-39
12.	WARRANTY AND GUARANTEE; TESTS AND INSPECTIONS; CORRECTION, REMOVAL OR ACCEPTANCE OF DEFECTIVE WORK.....	GC-39
13.	PAYMENTS TO CONTRACTOR AND COMPLETION	GC-43
14.	SUSPENSION OF WORK AND TERMINATION	GC-46
15.	MISCELLANEOUS	GC-49



DETAILED TABLE OF CONTENTS OF GENERAL CONDITIONS

1. Definitions
2. Preliminary Matters
 - 2.1 Delivery of Bonds
 - 2.2 Copies of Documents
 - 2.3 Commencement of Contract Time; Notice to Proceed
 - 2.4 Starting the Project
 - 2.5 Before Starting Construction
 - 2.6 Submittal of Schedules
 - 2.7 Preconstruction Conference
 - 2.8 Finalizing Schedules
3. Contract Documents, Intent, Conflicts, Amending, and Reuse
 - 3.1 General
 - 3.2 Intent
 - 3.3 Conflicts
 - 3.4 Amending and Supplementing Contract Documents
 - 3.5 Reuse of Documents
4. Availability of Lands, Physical Conditions, Reference Points
 - 4.1 Availability of Lands
 - 4.2 Physical Conditions
 - 4.3 Physical Conditions - Underground Facilities
 - 4.4 Reference Points
5. CONTRACTOR'S Responsibilities
 - 5.1 Supervision
 - 5.2 Superintendence
 - 5.3 Labor
 - 5.4 Start-Up and Completion of Work
 - 5.5 Materials and Equipment
 - 5.6 Adjusting Progress Schedule
 - 5.7 Substitutes or "Or-Equal" Items
 - 5.8 Subcontractors, Suppliers and Others
 - 5.9 Patent Fees and Royalties
 - 5.10 Permits
 - 5.11 Laws and Regulations
 - 5.12 Taxes
 - 5.13 Use of Premises

- 5.14 Record Drawings
- 5.15 Shop Drawings and Samples
- 5.16 Continuing the Work
- 5.17 Erosion and Sediment Control

- 6. Other Work
 - 6.1 Related Work at Site
 - 6.2 Other Contractors or Utility Owners
 - 6.3 Delays Caused By Others
 - 6.4 Coordination

- 7. OWNER'S Responsibilities
 - 7.1 Communications
 - 7.2 Data and Payments
 - 7.3 Lands, Easements, and Surveys
 - 7.4 Change Orders
 - 7.5 Inspections, Tests, and Approvals
 - 7.6 Stop or Suspend Work

- 8. CONSULTANT'S Status During Construction
 - 8.1 OWNER'S Representative
 - 8.2 Visits to Site
 - 8.3 Project Representation
 - 8.4 Clarification and Interpretations
 - 8.5 Authorized Variations in Work
 - 8.6 Rejecting Defective Work
 - 8.7 Shop Drawings
 - 8.8 Change Orders
 - 8.9 Payments
 - 8.10 Determinations for Unit Prices
 - 8.11 Decisions on Disputes
 - 8.12 Limitations on CONSULTANT'S Responsibilities

- 9. Changes in the Work
 - 9.1 OWNER May Order Changes
 - 9.2 Claims
 - 9.3 Work Not in Contract Documents
 - 9.4 Change Orders
 - 9.5 Notice of Change

10. Change of Contract Price
 - 10.1 Total Compensation
 - 10.2 Claim for Increase or Decrease in Price
 - 10.3 Value of Work
 - 10.4 Cost of the Work
 - 10.5 Not to Be Included in Cost of the Work
 - 10.6 CONTRACTOR'S Fee
 - 10.7 Itemized Cost Breakdown
 - 10.8 Cash Allowance
 - 10.9 Unit Price Work

11. Change of Contract Time
 - 11.1 Change Order
 - 11.2 Justification for Time Extension
 - 11.3 Time Limits

12. Warranty and Guarantee; Tests and Inspections; Correction, Removal or Acceptance of Defective Work
 - 12.1 Warranty and Guarantee
 - 12.2 Access to Work
 - 12.3 Tests and Inspections
 - 12.4 OWNER May Stop Work
 - 12.5 Correction or Removal of Defective Work
 - 12.6 One Year Correction Period
 - 12.7 Acceptance of Defective work
 - 12.8 Owner May Correct Defective Work

13. Payments to CONTRACTOR and Completion
 - 13.1 Schedule of Values
 - 13.2 Application for Progress Payments
 - 13.3 CONTRACTOR'S Warranty of Title
 - 13.4 Review of Application for Progress Payments
 - 13.5 Partial Utilization
 - 13.6 Final Inspection
 - 13.7 Final Application for Payment
 - 13.8 Final Payment and Acceptance
 - 13.9 CONTRACTOR'S Continuing Obligation
 - 13.10 Waiver of Claims

14. Suspension of Work and Termination

- 14.1 OWNER May Suspend Work
- 14.2 OWNER May Terminate
- 14.3 CONTRACTOR'S Services Terminated
- 14.4 Payment After Termination
- 14.5 CONTRACTOR May Stop or Terminate

15. Miscellaneous

- 15.1 Claims for Injury or Damage
- 15.2 Non-Discrimination in Employment
- 15.3 Temporary Street Closing or Blockage
- 15.4 Percentage of Work Performed by Prime CONTRACTOR
- 15.5 Clean-up
- 15.6 General
- 15.7 Debris Disposal

END OF SECTION

PART IV
GENERAL CONDITIONS

1. DEFINITIONS

Wherever used in these General Conditions or the other Contract Documents, the following terms have the meanings indicated which are applicable to both the singular and plural thereof.

1.1 Addenda

Written or graphic instruments issued prior to the opening of Bids which clarify, correct, or change the Bid Documents or the Contract Documents.

1.2 Agreement

The written agreement between OWNER and CONTRACTOR covering the Work to be performed; other Contract Documents are attached to the Agreement and made a part thereof as provided therein.

1.3 Application for Payment

The form accepted by CONSULTANT which is to be used by CONTRACTOR in requesting progress or final payments and which is to include such supporting documentation as is required by the Contract Documents.

1.4 Bid

The offer or proposal of the Bidder submitted on the prescribed form setting forth the prices for the Work to be performed.

1.5 Bidder

An individual, partnership, or corporation, who submit a Bid for a prime contract with the OWNER, for the Work described in the proposed Contract Documents.

1.6 Bonds

Bid, performance and payment bonds and other instruments of security.

1.7 Calendar Day

A calendar day of twenty-four hours measured from midnight to the next midnight shall constitute a day.

1.8 Change Order

A document recommended by CONSULTANT, which is signed by CONTRACTOR and OWNER and authorizes an addition, deletion or revision in the Work, or an adjustment in the Contract Price or the Contract Time, issued on or after the Effective Date of the Agreement.

1.9 Contract Documents

The Advertisement for Bidders, Information for Bidders, Agreement, Addenda (which pertain to the Contract Documents), CONTRACTOR'S Bid (including documentation accompanying the Bid and any post-bid documentation submitted prior to the Notice of Award) when attached as an exhibit to the Agreement, the Bonds, these General Conditions, the Special Conditions, the Specifications and the Drawings as the same are more specifically identified in the Agreement, together with all amendments, modifications and supplements.

1.10 Contract Unit Price

The monies payable by OWNER to CONTRACTOR under the Contract Documents as stated in the Agreement. Unit Prices are to be firm for the term of this Contract.

1.11 Contract Time

The number of consecutive calendar days between the date of issuance of the Notice to Proceed and the contract completion date.

1.12 CONTRACTOR

The person, firm or corporation with whom OWNER has entered into the Agreement.

1.13 Defective

An adjective which when modifying the word Work refers to Work that is unsatisfactory, faulty or deficient, or does not conform to the Contract Documents, or does not meet the requirements of any inspection, reference standard, test or approval referred to in the Contract Documents, or has been damaged prior to CONSULTANT'S recommendation of final payment (unless responsibility for the protection thereof has been assumed by OWNER).

1.14 Drawings

The drawings which show the character and scope of the Work to be performed and which have been prepared or approved by CONSULTANT and are referred to in the Contract Documents.

1.15 Effective Date of the Agreement

The date indicated in the Agreement on which it becomes effective.

1.16 CONSULTANT

The Lexington-Fayette Urban County Government or its authorized representative.

1.17 Field Order

A documented order issued by CONSULTANT which orders minor changes in the Work, but which does not involve a change in the Contract Price or the Contract Time.

- 1.18 Giving Notice**
Whenever any provision of the Contract Documents requires the giving of written notice, it will be deemed to have been validly given if delivered in person to the individual or to a member of the firm or to an officer of the corporation for whom it is intended, or if delivered at or sent by registered or certified mail, postage prepaid, to the last business address known to the giver of the notice.
- 1.19 Laws and Regulations**
Laws, rules, regulations, ordinances, codes and/or orders.
- 1.20 Notice of Award**
The written notice by OWNER to the apparent successful bidder stating that upon compliance by the apparent successful bidder with the conditions enumerated therein, within the time specified, OWNER will sign and deliver the Agreement.
- 1.21 Notice to Proceed**
A written notice given by OWNER to CONTRACTOR fixing the date on which the Contract Time will commence to run and on which CONTRACTOR shall start to perform CONTRACTOR'S obligations under the Contract Documents.
- 1.22 OWNER**
The Lexington-Fayette Urban County Government.
- 1.23 Partial Utilization**
Placing a portion of the Work in service for the purpose for which it is intended (or related purpose) before reaching Completion for all the Work.
- 1.24 Project**
The total construction of which the Work to be provided under the Contract Documents may be the whole, or a part as indicated elsewhere in the Contract Documents.
- 1.25 Inspector**
The authorized representative who is assigned to the site or any part thereof.
- 1.26 Shop Drawings**
All drawings, diagrams, illustrations, schedules and other data which are specifically prepared by or for CONTRACTOR to illustrate some portion of the Work and all illustrations, brochures, standard schedules, performance charts, instructions, diagrams and other information prepared by a Supplier and submitted by CONTRACTOR to illustrate material or equipment for some portion of the Work.
- 1.27 Specifications**
Those portions of the Contract Documents consisting of written technical descriptions of materials, equipment, construction systems, standards and

workmanship as applied to the Work and certain administrative details applicable thereto.

1.28 Standard Specifications

The "Standard Specifications for Road and Bridge Construction", Transportation Cabinet, Department of Highways, Commonwealth of Kentucky, current edition. MUTCD shall refer to the "Manual of Uniform Traffic Control Devices.

1.29 Subcontractor

An individual, firm or corporation having a direct contract with CONTRACTOR or with any other Subcontractor for the performance of a part of the Work at the site.

1.30 Special Conditions

The part of the Contract Documents which amends or supplements these General Conditions.

1.31 Supplier

A manufacturer, fabricator, supplier, distributor, materialman or vendor.

1.32 Underground Facilities

All pipelines, conduits, ducts, cables, wires, manholes, vaults, tanks, tunnels or other such facilities or attachments, and any encasements containing such facilities which have been installed underground to furnish any of the following services or materials: electricity, gases, steam, liquid petroleum products, telephone or other communications, cable television, sewage and drainage removal, traffic or other control systems or water.

1.33 Unit Price Work

Not applicable

1.34 Work

The entire completed construction or the various separately identifiable parts thereof required to be furnished under the Contract Documents. Work is the result of performing services, furnishing labor and furnishing and incorporating materials and equipment into the construction, all as required by the Contract Documents.

1.35 Time Period

When any period of time is referred to in the Contract Documents by days, it will be computed to exclude the first and include the last day of such period. If the last day of any such period falls on a Saturday or Sunday or on a day made a legal holiday by the law of the applicable jurisdiction, such day will be omitted from the computation.

2. **PRELIMINARY MATTERS**

2.1 **Delivery of Bonds**

When the CONTRACTOR delivers the executed Agreements to OWNER, CONTRACTOR shall also deliver to OWNER, such Bonds, Insurance Certificate, and Power of Attorney as CONTRACTOR may be required to furnish.

2.2 **Copies of Documents**

Owner shall furnish to CONTRACTOR up to three copies (unless otherwise specified in the Special Conditions) of the Contract Documents as are reasonably necessary for the execution of the Work. Additional copies will be furnished, upon request, at the cost of reproduction.

2.3 **Commencement of Contract Time; Notice to Proceed**

The Contract Time will commence to run on the day specified in the Notice to Proceed.

2.4 **Starting the Project**

CONTRACTOR shall start to perform the Work on the date when the Contract Time commences to run, but no Work shall be done at the site prior to the date on which the Contract Time commences to run.

2.5 **Before Starting Construction**

Before undertaking each part of the Work, CONTRACTOR shall carefully study and compare the Contract Documents and check and verify pertinent figures shown thereon and all applicable field measurements. CONTRACTOR shall promptly report in writing to CONSULTANT any conflict, error or discrepancy which CONTRACTOR may discover and shall obtain a written interpretation or clarification from CONSULTANT before proceeding with any Work affected thereby; however, CONTRACTOR shall not be liable to OWNER or CONSULTANT for failure to report any conflict, error or discrepancy in the Contract Documents, unless CONTRACTOR had actual knowledge thereof or should reasonably have known thereof.

2.6 **Submittal of Schedules**

Within ten days after the effective date of the Agreement (unless otherwise specified) CONTRACTOR shall submit to CONSULTANT for review:

2.6.1 an estimated progress schedule indicating the starting and completion dates of the various stages of the Work;

2.6.2 a preliminary schedule of Shop Drawing submissions; and

2.6.3 a preliminary schedule of values for all of the Work which will include quantities and prices of items aggregating the Contract Price and will subdivide the Work into costs per labor and materials by specification

section to serve as the basis for progress payments during construction. Such prices will include an appropriate amount of overhead and profit applicable to each item of Work which will be confirmed in writing by CONTRACTOR at the time of submission. Schedule of values shall be submitted on AIA G702/703 forms, or approved equal.

2.7 Preconstruction Conference

Before CONTRACTOR starts the Work at the proposed site, a conference attended by CONTRACTOR, CONSULTANT, EEO-Affirmative Action Officer, and other appropriate parties will be held to discuss the following issues: (1) The scheduling of the Work to be completed; (2) The procedures for handling shop drawings and other submittals; (3) The processing of applications for payment; (4) The establishment of an understanding among the involved parties in regard to the proposed project; (5) The establishment of procedures for effectively implementing the LFUCG's 10% minimum DBE goals; and (6) Requirement for Mechanic's Lien on Partial Applications for Payment.

2.8 Finalizing Schedules

At least ten days before submission of the first Application for Payment a conference attended by CONTRACTOR, CONSULTANT and others as appropriate will be held to finalize the schedules submitted in accordance with paragraph 2.6. The finalized progress schedule will be acceptable to CONSULTANT as providing orderly progression of the Work to completion within the Contract Time, but such acceptance will neither impose on CONSULTANT responsibility for the progress or scheduling of the Work nor relieve CONTRACTOR from full responsibility thereof. The finalized schedule of Shop Drawing submissions will be acceptable to CONSULTANT as providing a workable arrangement for processing the submissions. The finalized schedule of values will be acceptable to CONSULTANT as to form and substance.

3. CONTRACT DOCUMENTS: INTENT, CONFLICTS, AMENDING AND REUSE

3.1 General

The Contract Documents comprise the entire agreement between OWNER and CONTRACTOR concerning the Work. The Contract Documents are complementary; what is called for by one is as binding as if called for by all. The Contract Documents will be construed in accordance with the law of the place of the Project.

3.2 Intent

It is the intent of the Contract Documents to describe a functionally complete Project (or part thereof) to be constructed in accordance with the Contract Documents. Any Work, materials or equipment that may reasonably be inferred from the Contract Documents as being required to produce the intended result will be supplied whether or not specifically called for. When words which have a well-known technical or trade meaning are used

to describe Work, materials or equipment such words shall be interpreted in accordance with that meaning. Reference to standard specifications, manuals or codes of any technical society, organization or association, or to the laws or regulations of any governmental authority, whether such reference be specific or by implication, shall mean the latest standard specification, manual, code or laws or regulations in effect at the time of opening of Bids (or, on the Effective Date of the Agreement if there were no Bids), except as may be otherwise specifically stated. However, no provision of any referenced standard specification, manual or code (whether or not specifically incorporated by reference in the Contract Documents) shall be effective to change the duties and responsibilities of OWNER, CONTRACTOR or CONSULTANT, or any of their consultants, agents or employees from those set forth in the Contract Documents, nor shall it be effective to assign to CONSULTANT, or any of CONSULTANT'S consultants, agents or employees, any duty or authority to supervise or direct the furnishing or performance of the Work or any duty or authority to undertake responsibility contrary to the provisions of paragraph 8.12.3 or 8.12.4. Clarifications and interpretations of the Contract Documents shall be issued by CONSULTANT as provided in paragraph 8.4.

3.3 Conflicts

If, during the performance of the Work, CONTRACTOR finds a conflict, error or discrepancy in the Contract Documents, CONTRACTOR shall so report to CONSULTANT in writing at once and before proceeding with the Work affected thereby shall obtain a written interpretation or clarification from CONSULTANT; however, CONTRACTOR shall not be liable to OWNER or CONSULTANT for failure to report any conflict, error or discrepancy in the Contract Documents unless CONTRACTOR had actual knowledge thereof or should reasonably have known thereof.

In resolving such conflicts, errors and discrepancies, the documents shall be given precedence in the following order:

1. Agreement
2. Field and Change Orders
3. Addenda
4. Special Conditions
5. Instruction to Bidders
6. General Conditions
7. Specifications and Drawings

Figure dimension on drawings shall govern over scale dimensions and detailed Drawings shall govern over general Drawings.

3.4 Amending and Supplementing Contract Documents

The Contract Documents may be amended to provide for additions, deletions and revisions in the Work or to modify the terms and conditions thereof by means of a Change Order or a Field Order. Contract Price and Contract Time may only be changed by a Change Order.

3.5 Reuse of Documents

Neither CONTRACTOR nor any Subcontractor or Supplier or other person or organization performing or furnishing any of the Work under a direct or indirect contract with OWNER shall have or acquire any title to or ownership rights in any of the Drawings, Specifications or other documents (or copies of any thereof) prepared by or bearing the seal of CONSULTANT; and they shall not reuse any of them on extensions of the Project or any other project without written consent of OWNER and CONSULTANT and specific written verification or adaptation by CONSULTANT.

4. AVAILABILITY OF LANDS; PHYSICAL CONDITIONS, REFERENCE POINTS

4.1 Availability of Lands

OWNER shall furnish, as indicated in the Contract Documents, the lands upon which the Work is to be performed, rights-of-way and easements for access thereto, and such other lands which are designated for the use of CONTRACTOR. Easements for permanent structures or permanent changes in existing facilities will be obtained and paid for by OWNER, unless otherwise provided in the Contract Documents. If CONTRACTOR believes that any delay in OWNER'S furnishing these lands, rights-of-way or easements entitles CONTRACTOR to an extension of the Contract Time, CONTRACTOR may make a claim therefor as provided in Article 11. CONSULTANT shall determine if the claim is legitimate or not. CONTRACTOR shall provide for all additional lands and access thereto that may be required for temporary construction facilities or storage of materials and equipment.

4.2 Physical Conditions

4.2.1 Explorations and Reports

Reference is made to the Special Conditions for identification of those reports of explorations and tests of subsurface conditions at the site that have been utilized by CONSULTANT in preparation of the Contract Documents. CONTRACTOR may rely upon the accuracy of the technical data contained in such reports, but not upon non-technical data, interpretations or opinions contained therein or for the completeness thereof for CONTRACTOR'S purposes. Except as indicated in the immediately preceding sentence and in paragraph 4.2.6, CONTRACTOR shall have full responsibility with respect to subsurface conditions at the site.

4.2.2 Existing Structures

Reference is made to the Special Conditions for identification of those drawings of physical conditions in or relating to existing surface and

subsurface structures (except Underground Facilities referred to in paragraph 4.3 which are at or contiguous to the site that have been utilized by CONSULTANT in preparation of the Contract Documents. CONTRACTOR may rely upon the accuracy of the technical data contained in such drawings, but not for the completeness thereof for CONTRACTOR'S purposes. Except as indicated in the immediately preceding sentence and in paragraph 4.2.6, CONTRACTOR shall have full responsibility with respect to physical conditions in or relating to such structures.

4.2.3 Report of Differing Conditions

If CONTRACTOR believes that:

4.2.3.1 any technical data on which CONTRACTOR is entitled to rely as provided in paragraphs 4.2.1 and 4.2.2 is inaccurate, or

4.2.3.2 any physical conditions uncovered or revealed at the site differ materially from that indicated, reflected or referred to in the Contract Documents,

CONTRACTOR shall, promptly after becoming aware thereof and before performing and WORK in connection therewith (except in an emergency) notify OWNER and CONSULTANT in writing about the inaccuracy or difference.

4.2.4 CONSULTANT'S Review

CONSULTANT will promptly review the pertinent conditions, determine the necessity of obtaining additional explorations or tests with respect thereto and advise CONTRACTOR of CONSULTANT'S findings and conclusions.

4.2.5 Possible Document Change

If CONSULTANT concludes that there is a material error in the Contract Documents or that because of newly discovered conditions a change I the Contract Documents is required, a Change Order will be issued as provided in Article 10 to reflect and document the consequences of the inaccuracy or difference.

4.2.6 Possible Price and Time Adjustments

In each such case, an increase or decrease in the Contract Price or an extension or shortening of the Contract Time, or any combination thereof, will be allowable to the extent that they are attributable to any such inaccuracy or difference.

4.3 **Physical Conditions-Underground Facilities**

4.3.1 Shown or Indicated

The information and data shown or indicated in the Contract Documents with respect to existing Underground Facilities at or contiguous to the site is

based on information and data furnished to OWNER or CONSULTANT by the owners of such underground facilities or by others. Unless it is otherwise expressly provided in the Special Conditions:

4.3.1.1 OWNER and CONSULTANT shall not be responsible for the accuracy or completeness of any such information or data; and,

4.2.1.2 CONTRACTOR shall have full responsibility for reviewing and checking all such information and data; for locating all underground facilities shown or indicated in the Contract Documents; for coordination of the Work with the owners of such underground facilities during construction; and for the safety and protection thereof and repairing any damage thereto resulting from the Work, the cost of all of which will be considered as having been included in the Contract Price.

4.3.2 Not Shown or Indicated

If an underground facility is uncovered or revealed at or contiguous to the site which was not shown or indicated in the Contract Documents and which CONTRACTOR could not reasonably have been expected to be aware of, CONTRACTOR shall, promptly after becoming aware thereof and before performing any Work affected thereby (except in an emergency), identify the owner of such Underground Facility and give written notice thereof to that owner and to OWNER and CONSULTANT. CONSULTANT will promptly review the underground facility to determine the extent to which the Contract Documents should be modified to reflect and document the consequences of the existence of the Underground Facility, and the Contract Documents will be amended or supplemented to the extent necessary. During such time, CONTRACTOR shall be responsible for the safety and protection of such underground facility. CONTRACTOR shall be allowed an increase in the Contract Price or an extension of the Contract Time, or both, to the extent that they are attributable to the existence of any underground facility that was not shown or indicated in the Contract Documents and which CONTRACTOR could not reasonably have been expected to be aware of.

4.4 Reference Points

OWNER shall provide engineering surveys to establish reference points for construction which in CONSULTANT'S judgment are necessary to enable CONTRACTOR to proceed with the Work. CONTRACTOR shall be responsible for laying out the Work (unless otherwise specified), shall protect and preserve the established reference points and shall make no changes or relocations without the prior written approval of OWNER. CONTRACTOR shall report to CONSULTANT whenever any reference point is lost or destroyed or requires relocation because of necessary changes in grades or locations, and shall be responsible for the accurate replacement or relocation of such reference points by a Registered Land Surveyor.

5. CONTRACTOR'S RESPONSIBILITIES

5.1 Supervision

CONTRACTOR shall supervise and direct the Work competently and efficiently, devoting such attention thereto and applying such skills and expertise as may be necessary to perform the Work in accordance with the Contract Documents. CONTRACTOR shall assure that all CONTRACTOR personnel (including subcontractors, etc.) conduct themselves in a courteous and respectful manner toward the CONSULTANT and the general public. CONTRACTOR shall keep at the Project Site during the progress of the Work a competent project manager/superintendent and all necessary assistants, all of whom shall be satisfactory to OWNER. OWNER reserves the right to reject CONTRACTOR'S construction superintendent and project management personnel if they are unsatisfactory to OWNER and upon such rejection CONTRACTOR shall designate and provide competent successors. Failure to comply with this condition of the Contract will result in immediate suspension of the Work. Following a review by the Commissioner of Public Works, the Contract may be terminated (see GC section 14). CONTRACTOR shall be solely responsible for the means, methods, techniques, sequences and procedures of construction, but CONTRACTOR shall not be responsible for the negligence of others in the design or selection of a specific means, method, technique, sequence or procedure of construction which is indicated in and required by the Contract Documents. CONTRACTOR shall be responsible to see that the finished Work complies accurately with the Contract Documents.

5.2 Superintendence

CONTRACTOR shall keep on the Work at all times during its progress a competent resident superintendent, who shall not be replaced without written notice to OWNER and CONSULTANT except under extraordinary circumstances. The superintendent will be CONTRACTOR'S representative at the site and shall have authority to act on behalf of CONTRACTOR. All communications given to the superintendent shall be as binding as if given to CONTRACTOR.

5.3 Labor

CONTRACTOR shall provide competent, suitably qualified personnel to survey and lay out the Work and perform construction as required by the Contract Documents. CONTRACTOR shall at all times maintain good discipline and order at the site. OWNER reserves the right to require CONTRACTOR to remove from the Project any of its personnel, or subcontractor's personnel for violating LFUCG Policies, Rules or Regulations. Except in connection with the safety or protection of persons or the Work or property at the site or adjacent thereto, and except as otherwise indicated in the Contract Documents, all Work at the site shall be performed during regular working hours, and CONTRACTOR will not permit overtime work or the performance of Work on Saturday, Sunday or any legal holiday without OWNER'S written consent given after prior written notice to CONSULTANT.

5.4 Start-Up and Completion of Work

Unless otherwise specified, CONTRACTOR shall furnish and assume full responsibility for all materials, equipment, labor, transportation, construction equipment and machinery, tools, appliances, fuel, power, light, heat, telephone, water, sanitary facilities, temporary facilities and all other facilities and incidentals necessary for the furnishing, performance, testing, start-up and completion of the Work.

5.5 Materials and Equipment

All materials and equipment shall be of good quality and new, except as otherwise provided in the Contract Documents. If required by CONSULTANT, CONTRACTOR shall furnish satisfactory evidence (including reports of required tests) as to the kind and quality of materials and equipment. All materials and equipment shall be applied, installed, connected, erected, used, cleaned and conditioned in accordance with the instructions of the applicable supplier except as otherwise provided in the Contract Documents; but no provision of any such instructions will be effective to assign to CONSULTANT, or any of CONSULTANT'S consultants, agents or employees, any duty or authority to supervise or direct the furnishing or performance of the Work or any duty or authority to undertake responsibility contrary to the provisions of paragraph 8.12.3 or 8.12.4.

5.5.1 Not Clearly Specified or Indicated

In all instances where materials specified are obtainable in different sizes, weights, trade grades, qualities or finishes, etc., whose weights, trade grades, qualities or finishes, etc., are not clearly specified or indicated on the Drawings, the CONTRACTOR shall notify the CONSULTANT of all such instances at least five (5) days in advance of receiving the proposals. The CONSULTANT will then determine which size, weight, trade grade, quality, finish, etc., is required.

5.5.2 Coordination of Work

The CONTRACTOR shall see that for his own Work and for the work of each subcontractor, proper templates and patterns necessary for the coordination of the various parts of the Work are prepared. The CONTRACTOR shall furnish or require the Subcontractor to furnish such duplicates as will enable the Subcontractors to fit together and execute fully their respective portions of the Work.

5.6 Adjusting Progress Schedule

CONTRACTOR shall submit to CONSULTANT for acceptance (to the extent indicated in paragraph 2.8) adjustments in the progress schedule to reflect the impact thereon of new developments; these will conform generally to the progress schedule then in effect and additionally will comply with any provisions of the Contract Documents applicable thereto.

5.7 Substitutes or "Or-Equal" Items

5.7.1 General

Whenever materials or equipment are specified or described in the Contract Documents by using the name of a proprietary item or the name of a particular supplier, the naming of the item is intended to establish the type, function, and quality required. Unless the name is followed by words indicating that no substitution is permitted, materials or equipment of other Suppliers may be accepted by OWNER/CONSULTANT if sufficient information is submitted by CONTRACTOR to allow OWNER/CONSULTANT to determine that the material or equipment proposed is equivalent or equal to that named. The procedure for review by OWNER/CONSULTANT will include the following. Requests for review of substitute items of material and equipment will not be accepted by OWNER/CONSULTANT from anyone, other than CONTRACTOR. If CONTRACTOR wishes to furnish or use a substitute item of material or equipment, CONTRACTOR shall make written application to OWNER/CONSULTANT for acceptance thereof, certifying that the proposed substitute will perform adequately the functions and achieve the results called for by the general design, be similar and of equal substance to that specified and be suited to the same use as that specified. The application will state that the evaluation and acceptance of the proposed substitute will not prejudice CONTRACTOR'S achievement of completion on time, whether or not acceptance of the substitute for use in the Work will require a change in any of the Contract Documents (or in the provisions of any other direct contract with OWNER for work on the Project) to adapt the design to the proposed substitute and whether or not incorporation or use of the substitute in connection with the Work is subject to payment of any license fee or royalty. All variations of the proposed substitute from that specified will be identified in the application and available maintenance, repair and replacement service will be indicated. The application will also contain an itemized estimate of all costs that will result directly or indirectly from acceptance of such substitute, including costs of redesign and claims of other contractors affected by the resulting change, all of which shall be considered by OWNER/CONSULTANT in evaluating the proposed substitute. OWNER/CONSULTANT may require CONTRACTOR to furnish at CONTRACTOR'S expense additional data about the proposed substitute.

5.7.2 Substitutes

If a specific means, method, technique, sequence or procedure of construction is indicated in or required by the Contract Documents, CONTRACTOR may furnish or utilize a substitute means, method, sequence, technique or procedure of construction acceptable to OWNER/CONSULTANT, if CONTRACTOR submits sufficient information to allow OWNER/CONSULTANT to determine that the substitute proposed is equivalent to that indicated or required by the Contract Documents. The procedure for review by OWNER/CONSULTANT will be

similar to that provided in paragraph 5.7.1 as applied by OWNER/CONSULTANT.

5.7.3 OWNER/CONSULTANT'S Approval

OWNER/CONSULTANT will be allowed a reasonable time within which to evaluate each proposed substitute. OWNER/CONSULTANT will be the sole judge of acceptability, and no substitute will be ordered, installed or utilized without OWNER/CONSULTANT'S prior written acceptance which will be evidenced by either a Change Order or an approved Shop Drawing. OWNER may require CONTRACTOR to furnish at CONTRACTOR'S expense a special performance guarantee or other surety with respect to any substitute. OWNER/CONSULTANT will record time required by OWNER/CONSULTANT and OWNER/CONSULTANT'S consultants in evaluating substitutions proposed by CONTRACTOR and in making changes in the Contract Documents occasioned thereby. Whether or not OWNER/CONSULTANT accepts a proposed substitute, CONTRACTOR shall reimburse OWNER for the charges of OWNER/CONSULTANT and OWNER/CONSULTANT'S consultants for evaluating each proposed substitute.

5.8 Subcontractors, Suppliers, and Others

5.8.1 Acceptable to CONSULTANT

CONTRACTOR shall not employ any Subcontractor, Supplier or other person or organization (including those acceptable to OWNER and CONSULTANT as indicated in paragraph 5.8.2), whether initially or as a substitute, against whom OWNER or CONSULTANT may have reasonable objection. CONTRACTOR shall not be required to employ any Subcontractor, Supplier or other person or organization to furnish or perform any of the Work against whom CONTRACTOR has reasonable objection.

5.8.2 Objection After Due Investigation

If the Contract Documents require the identity of certain Subcontractors, Suppliers or other persons or organizations (including those who are to furnish the principal items of materials and equipment) to be submitted to OWNER in advance of the specified date prior to the Effective Date of the Agreement for acceptance by OWNER and CONSULTANT and if CONTRACTOR has submitted a list thereof, OWNER'S or CONSULTANT'S acceptance (either in writing or by failing to make written objection thereto by the date indicated for acceptance or objection in the bidding documents or the Contract Documents) of any such Subcontractor, Supplier or other person or organization so identified may be revoked on the basis of reasonable objection after due investigation, in which case CONTRACTOR shall submit an acceptable substitute. No acceptance by OWNER or CONSULTANT of any such Subcontractor, Supplier or other

person or organization shall constitute a waiver of any right of OWNER or CONSULTANT to reject defective Work.

5.8.3 Contractor Responsible for Acts of Subcontractors

The CONTRACTOR shall perform on the site, and with its own organization, work equivalent to at least fifty (50) percent of the total amount of Work to be performed under the Contract. This percentage may be reduced by a supplemental agreement to this Contract if, during performing the Work, the CONTRACTOR requests a reduction and the Urban County project manager determines that the reduction would be to the advantage of the Urban County Government.

The CONTRACTOR shall, at the time he submits his proposal for the Contract, notify the OWNER in writing of the names of Subcontractors proposed for the Work. He shall not employ any Subcontractor without the prior written approval of the OWNER.

CONTRACTOR shall be fully responsible to OWNER and CONSULTANT for all acts and omissions of the Subcontractors, Suppliers and other persons and organizations performing or furnishing any of the Work under a direct or indirect contract with CONTRACTOR just as CONTRACTOR is responsible for CONTRACTOR'S own acts and omissions. Nothing in the Contract Documents shall create any contractual relationship between OWNER or CONSULTANT and any such Subcontractor, Supplier or other person or organization, nor shall it create any obligation on the part of OWNER or CONSULTANT to pay or to see to the payment of any moneys due any such Subcontractor, Supplier or other person or organization except as may otherwise be required by Laws and Regulations.

5.8.4 Division of Specifications

The divisions and sections of the Specifications and the identifications of any Drawings shall not control CONTRACTOR in dividing the Work among Subcontractors or Suppliers or delineating the Work to be performed by any specific trade.

5.8.5 Agreement Between Contractor and Subcontractors

All Work performed for CONTRACTOR by a Subcontractor will be pursuant to an appropriate agreement between CONTRACTOR and the Subcontractor which specifically binds the Subcontractor to the applicable terms and conditions of the Contract Documents for the benefit of OWNER and CONSULTANT.

5.8.6 Statements and Comments by CONTRACTOR

Neither the CONTRACTOR, his employees, nor his subcontractors shall at any time make any statement or comment as to the project scope, nature, intention, design, or construction

method to any third party or parties without the explicit written consent of the OWNER.

Any third party requesting such information shall be referred to the OWNER or his representative.

Should there be any change from the original intent of the project as a result of any statement or comment by the contractor, his employees or subcontractors, contractor shall be held liable for any change in the scope, nature, design, or construction method and shall bear the full cost for the previously mentioned changes.

5.9 Patent Fees and Royalties

CONTRACTOR shall pay all license fees and royalties and assume all costs incident to the use in the performance of the Work or the incorporation in the Work of any invention, design, process, product or device which is the subject of patent rights or copyrights held by others.

5.10 Permits

Unless otherwise provided in the Special conditions, CONTRACTOR shall obtain and pay for all construction permits and licenses. OWNER shall assist CONTRACTOR, when necessary, in obtaining such permits and licenses. CONTRACTOR shall pay all governmental charges and inspection fees necessary for the prosecution of the Work, which are applicable at the time of opening of Bids, or if there are no Bids on the Effective Date of the Agreement. CONTRACTOR shall pay all charges of utility owners for connections to the Work, and OWNER shall pay all charges of such utility owners for capital costs related thereto such as plant investment fees.

5.11 Laws and Regulations

5.11.1 CONTRACTOR to Comply

CONTRACTOR shall give all notices and comply with all Laws and Regulations applicable to furnishing and performance of the Work. Except where otherwise expressly required by applicable Laws and Regulations, neither OWNER nor CONSULTANT shall be responsible for monitoring CONTRACTOR'S compliance with any Laws and Regulations.

5.11.2 Specifications and Drawings at Variance

If CONTRACTOR observes that the Specifications or Drawings are at variance with any Laws or Regulations, CONTRACTOR shall give CONSULTANT prompt written notice thereof, and any necessary changes will be authorized by one of the methods indicated in paragraph 3.4. If CONTRACTOR performs any Work knowing or having reason to know that it is contrary to such Laws, or Regulations, and without such notice to CONSULTANT, CONTRACTOR shall bear all costs arising therefrom; however, it shall not be CONTRACTOR'S primary responsibility to make certain that the Specifications and Drawings are in accordance with such Laws and Regulations.

Any party, firm or individual submitting a proposal pursuant to invitation must have paid all taxes owed to the Lexington-Fayette Urban County Government at the time the proposal is submitted, and must maintain a "current" status in regard to those taxes throughout the Contract. If applicable, business must be licensed in Fayette County.

5.12 Taxes

CONTRACTOR shall pay all sales, consumer, use and other similar taxes required to be paid by CONTRACTOR in accordance with the Laws and Regulations of the place of the Project which are applicable during the performance of the Work. Any party, firm or individual submitting a proposal pursuant to invitation must have paid all taxes owed to the Lexington-Fayette Urban County Government at the time the proposal is submitted, and must maintain a "current" status in regard to those taxes throughout the Contract. If applicable, business must be licensed in Fayette County.

5.13 Use of Premises

5.13.1 Project Site

CONTRACTOR shall confine construction equipment, the storage of materials and equipment and the operations of workers to the staging areas or work site areas identified in and permitted by the Contract Documents and other land and areas permitted by Laws and Regulations, rights-of-way, permits and easements, and shall not unreasonably encumber the premises with construction equipment or other materials or equipment. CONTRACTOR shall assume full responsibility for any damage to any such

land or area, or to the owner or occupant thereof or of any land or areas contiguous thereto, resulting from the performance of the Work. Should any claim be made against OWNER or CONSULTANT by any such owner or occupant because of the performance of the Work, CONTRACTOR shall promptly attempt to settle with such other party by agreement or otherwise resolve the claim by arbitration or at law. CONTRACTOR shall, to the fullest extent permitted by Laws and Regulations, indemnify and hold OWNER and CONSULTANT harmless from and against all claims, damages, losses and expenses (including, but not limited to, fees of engineers, architects, attorneys and other professionals and court and arbitration costs) arising directly, indirectly or consequentially out of any action, legal or equitable, brought by any such other party against OWNER or CONSULTANT to the extent based on a claim arising out of CONTRACTOR'S performance of the Work.

5.13.2 Clean UP

During the progress of the Work, CONTRACTOR shall keep the premises free from accumulations of waste materials, rubbish and other debris resulting from the Work. At the completion of the Work, CONTRACTOR shall remove all waste materials, rubbish and debris from and about the premises as well as all tools, appliances, construction equipment and machinery, and surplus materials, and shall leave the site clean and ready for occupancy by OWNER. CONTRACTOR shall restore to original condition all property not designated for alteration by the Contract Documents.

5.13.1 Loading of Structures

CONTRACTOR shall not load nor permit any part of any structure to be loaded in any manner that will endanger the structure, nor shall CONTRACTOR subject any part of the Work or adjacent property to stresses or pressures that will endanger it.

5.14 **Record Drawings**

CONTRACTOR shall maintain in a safe place at the site one record copy of all Drawings, Specifications, Addenda, Change Orders, Field Orders and written interpretations and clarifications (issued pursuant to paragraph 9.4) in good order and annotated to show all changes made during construction. These record documents together with all approved samples and a counterpart of all approved Shop Drawings will be available to CONSULTANT for reference. Upon completion of the Work, these record documents, samples and Shop Drawings will be delivered to CONSULTANT for OWNER.

5.15 **Shop Drawings and Samples**

5.15.1 Shop Drawing Submittals

After checking and verifying all field measurements and after complying

with applicable procedures specified, CONTRACTOR shall submit to CONSULTANT for review and approval in accordance with the accepted schedule of Shop Drawing submissions (see paragraph 2.8), or for other appropriate action if so indicated in the Special Conditions, five copies (unless otherwise specified) of all Shop Drawings, which will bear a stamp or specific written indication that CONTRACTOR has satisfied CONTRACTOR'S responsibilities under the Contract Documents with respect to the review of the submission. All submissions will be identified as CONSULTANT may require. The data shown on the Shop Drawings will be complete with respect to quantities, dimensions, specified performance and design criteria, materials and similar data to enable CONSULTANT to review the information as required.

5.15.2 Sample Submittals

CONTRACTOR shall also submit to CONSULTANT for review and approval with such promptness as to cause no delay in Work, all samples required by the Contract Documents. All samples will have been checked by and accompanied by a specific written indication that CONTRACTOR has satisfied CONTRACTOR'S responsibilities under the Contract Documents with respect to the review of the submission and will be identified clearly as to material, Supplier, pertinent data such as catalog numbers and the use for which intended.

5.15.3 Review by CONTRACTOR

Before submission of each Shop Drawing or sample CONTRACTOR shall have determined and verified all quantities, dimensions, specified performance criteria, installation requirements, materials, catalog numbers and similar data with respect thereto and reviewed or coordinated each Shop Drawing or sample with other Shop Drawings and samples and with the requirements of the Work and the Contract Documents.

5.15.4 Notice of Variation

At the time of each submission, CONTRACTOR shall give CONSULTANT specific written notice of each variation that the Shop Drawings or samples may have from the requirements of the Contract Documents, and, in addition, shall cause a specific notation to be made on each Shop Drawing submitted to CONSULTANT for review and approval of each such variation.

5.15.5 CONSULTANT'S Approval

CONSULTANT will review and approve with reasonable promptness Shop Drawings and samples, but CONSULTANT'S review and approval will be only for conformance with the design concept of the Project and for compliance with the information given in the Contract Documents and shall not extend to means, methods, techniques, sequences or procedures of construction (except where a specific means, method, technique, sequence or

procedure of construction is indicated in or required by the Contract Documents) or to safety precautions or programs incident thereto. The review and approval of a separate item as such will not indicate approval of the assembly in which the item functions. CONTRACTOR shall make corrections required by CONSULTANT, and shall return the required number of corrected copies of Shop Drawings and submit, as required, new samples for review and approval. CONTRACTOR shall direct specific attention in writing to revisions other than the corrections called for by CONSULTANT on previous submittals.

5.15.6 Responsibility for Errors and Omissions

CONSULTANT'S review and approval of Shop Drawings or samples shall not relieve CONTRACTOR from responsibility for any variation from the requirements of the Contract Documents unless CONTRACTOR has in writing called CONSULTANT'S attention to each such variation at the time of submission as required by paragraph 5.15.4 and CONSULTANT has given written approval of each such variation by a specific written notation thereof incorporated in or accompanying the Shop Drawing or sample approval; nor will any approval by CONSULTANT relieve CONTRACTOR from responsibility for errors or omissions in the Shop Drawings or from responsibility for having complied with the provisions of paragraph 5.15.3.

5.15.7 Cost of Related Work

Where a Shop or sample is required by the Specifications, any related Work performed prior to CONSULTANT'S review and approval of the pertinent submission will be the sole expense and responsibility of CONTRACTOR.

5.16 Continuing the Work

CONTRACTOR shall carry on the Work and adhere to the progress schedule during all disputes or disagreements with OWNER. No Work shall be delayed or postponed pending resolutions of any disputes or disagreements, except as permitted by paragraph 14.5 or as CONTRACTOR and OWNER may otherwise agree in writing.

5.17 Erosion and Sediment Control

5.17.1 General Environmental Requirements

The CONTRACTOR and Subcontractors performing work on projects on behalf of the OWNER shall comply with all applicable federal, state, and local environmental regulations and all requirements and conditions set forth in "special" permits including but not limited to Corp of Engineers 404 permits, 401 Water Quality Certifications, Stream Crossing and Floodplain Encroachment Permits.

Any fines or penalties resulting from the failure to comply with the terms of the federal, state or local permits or perform necessary corrective action are solely the obligation of the CONTRACTOR.

5.17.2 Stormwater Pollution Prevention

A. The CONTRACTOR shall exercise due care to prevent or minimize any damage to any stream or wetland from pollution by debris, sediment or other material. The operation of equipment and/or materials in a jurisdictional wetland is expressly prohibited. Water that has been used for washing or processing, or that contains oils, sediments or other pollutants shall not be discharged from the job site. Such waters shall be collected and properly disposed of by the CONTRACTOR in accordance with applicable local, state and federal law.

B. The CONTRACTOR is solely responsible for securing all required state and local permits associated with stormwater discharges from the project including, but not necessarily limited to the KY Notice of Intent to Disturb (NOI) for Coverage of Storm Water Discharges Associated with Construction Activities under the KPDES Storm Water General Permit KYR100000 and the LFUCG, Land Disturbance Permit. Permit application preparation and all required documentation are the responsibility of the CONTRACTOR. The CONTRACTOR is solely responsible for maintaining compliance with the stormwater pollution prevention plan or erosion and sediment control plan and ensuring the following:

- a. That the Stormwater Pollution Prevention Plan (SWPPP) or erosion control plan is current and available for review on site;
- b. That any and all stormwater inspection reports required by the permit are conducted by qualified personnel and are available for review onsite; and
- c. That all best management practices (BMPs) are adequately maintained and effective at controlling erosion and preventing sediment from leaving the site.

C. The CONTRACTOR shall provide the necessary equipment and personnel to perform any and all emergency measures that may be required to contain any spillage or leakage and to remove materials, soils or liquids that become contaminated. The collected spill material shall be properly disposed at the CONTRACTOR's expense.

D. Upon completion of the work and with the concurrence of the OWNER, the CONTRACTOR must file a Notice of Termination (NOT) of Coverage Under the KPDES General Permit for Storm Water Discharges Associated with Construction Activity with the appropriate local and state authorities.

E. Any fines or penalties resulting from the failure to comply with the terms of the state or local stormwater permits or perform necessary corrective action are solely the obligation of the CONTRACTOR.

6. OTHER WORK

6.1 Related Work at Site

OWNER may perform other work related to the Project at the site by OWNER'S own forces, have other work performed by utility owners or let other direct contracts therefor which shall contain General Conditions similar to these. If the fact that such other work is to be performed was not noted in the Contract Documents, written notice thereof will be given to CONTRACTOR prior to starting any such other work; and, if such performance will involve additional expense to CONTRACTOR or requires additional time, a Change Order to the Contract will be negotiated.

6.2 Other Contractors or Utility Owners

CONTRACTOR shall afford each utility owner and other contractor who is a party to such a direct contract (or OWNER, if OWNER is performing the additional work with OWNER'S employees) proper and safe access to the site and a reasonable opportunity for the introduction and storage of materials and equipment and the execution of such work, and shall properly connect and coordinate the Work with theirs. CONTRACTOR shall do all cutting, fitting and patching of the Work that may be required to make its several parts come together properly and integrate with such other work. CONTRACTOR shall not endanger any work of others by cutting, excavating or otherwise altering their work and will only cut or alter their work with the written consent of CONSULTANT and the others whose work will be affected. The duties and responsibilities of CONTRACTOR under this paragraph are for the benefit of such utility owners and other contractors to the extent that there are comparable provisions for the benefit of CONTRACTOR in said direct contracts between OWNER and such utility owners and other contractors.

6.3 Delays Caused by Others

If any part of CONTRACTOR'S Work depends for proper execution or results upon the work of any such other contractor or utility owner (or OWNER), CONTRACTOR shall inspect and promptly report to CONSULTANT in writing any delays, defects or deficiencies in such work that render it unavailable or unsuitable for such proper execution and results. CONTRACTOR'S failure so to report will constitute an acceptance of the other work as fit and proper for integration with CONTRACTOR'S Work except for latent or non-apparent defects and deficiencies in the other work.

6.4 Coordination

If OWNER contracts with others for the performance of other work on the Project at the site, the person or organization who will have authority and responsibility for coordination of the activities among the various prime contractors will be identified in the Special Conditions, and the specific matters to be covered by such authority and

responsibility will be itemized, and the extent of such authority and responsibilities will be provided, in the Special Conditions.

7. OWNER'S RESPONSIBILITIES

7.1 Communications

OWNER shall issue all communications to CONTRACTOR through CONSULTANT.

7.2 Data and Payments

OWNER shall furnish the data required of OWNER under the Contract Documents promptly after they are due.

7.3 Lands, Easements, and Surveys

OWNER'S duties in respect of providing lands and easements and providing engineering surveys to establish reference points are set forth in paragraphs 4.1 and 4.4. Paragraph 4.2 refers to OWNER'S identifying and making available to CONTRACTOR copies of reports of explorations and tests of subsurface conditions at the site and in existing structures which have been utilized by CONSULTANT in preparing the Drawings and Specifications.

7.4 Change Orders

OWNER is obligated to execute Change Orders as indicated in paragraph 9.4.

7.5 Inspections, Tests and Approvals

OWNER'S responsibility in respect to certain inspections, tests and approvals is set forth in paragraph 13.3.

7.6 Stop or Suspend Work

In connection with OWNER'S right to stop Work or suspend Work, see paragraph 12.4 and 14.1 Paragraph 14.2 deals with OWNER'S rights to terminate services of CONTRACTOR under certain circumstances.

8. CONSULTANT'S STATUS DURING CONSTRUCTION

8.1 OWNER'S Representative

CONSULTANT will be OWNER'S representative during the construction period. The duties and responsibilities and the limitations of authority of CONSULTANT as OWNER'S representative during construction are set forth in the Contract Documents and shall not be extended without written consent of OWNER and CONSULTANT.

8.2 Visits to Site

CONSULTANT will make visits to the site at intervals appropriate to the various stages of construction to observe the progress and quality of the executed Work and to determine, in general, if the Work is proceeding in accordance with the Contract Documents. CONSULTANT will not be required to make exhaustive or

continuous on-site inspections to check the quality or quantity of the Work. CONSULTANT'S efforts will be directed toward providing for OWNER a greater degree of confidence that the completed Work will conform to the Contract Documents. On the basis of such visits and on-site observations, CONSULTANT will keep OWNER informed of the progress of the Work and will endeavor to guard OWNER against defects and deficiencies in the Work.

8.3 Project Representation

CONSULTANT will provide an Inspector to assist CONSULTANT in observing the performance of the Work. If OWNER designates another agent to represent OWNER at the site who is not CONSULTANT'S agent or employee, the duties, responsibilities and limitations of authority of such other person will be as provided in the Special Conditions.

8.4 Clarifications and Interpretations

CONSULTANT will issue with reasonable promptness such written clarifications or interpretations of the requirements of the Contract Documents (in the form of Drawings or otherwise) as CONSULTANT may determine necessary, which shall be consistent with or reasonably inferable from the overall intent of the Contract Documents.

8.5 Authorized Variations in Work

CONSULTANT may authorize minor variations in the Work from the requirements of the Contract Documents which do not involve an adjustment in the Contract Price or the Contract Time and are consistent with the overall intent of the Contract Documents. These may be accomplished by a Field Order.

8.6 Rejecting Defective Work

CONSULTANT will have authority to disapprove or reject Work which CONSULTANT believes to be defective, and will also have authority to require special inspection or testing of the Work as provided in paragraph 12.3, whether or not the Work is fabricated, installed or completed.

8.7 Shop Drawings

In connection with CONSULTANT'S responsibility for Shop Drawings and samples, see paragraphs 5.15.1 through 5.16 inclusive.

8.8 Change Orders

In connection with CONSULTANT'S responsibilities as to Change Orders, see Articles 10, 11 and 12.

8.9 Payments

In connection with CONSULTANT'S responsibilities with respect to Applications for Payment, etc., see Article 13.

8.10 Determinations for Unit Prices

CONSULTANT will determine the actual quantities and classifications of Unit Price Work performed by CONTRACTOR.

CONSULTANT will review with CONTRACTOR CONSULTANT'S preliminary determinations on such matters before rendering a written decision thereon (by recommendation of an Application for Payment or otherwise).

8.11 Decision on Disputes

CONSULTANT will be the initial interpreter of the requirements of the Contract Documents and judge of the acceptability of the Work thereunder. Claims, disputes and other matters relating to the acceptability of the Work or the interpretation of the requirements of the Contract Documents pertaining to the performance and furnishing of the Work and claims under Articles 10 and 11 in respect of changes in the Contract Price or Contract Time will be referred initially to CONSULTANT in writing with a request for a formal decision in accordance with this paragraph, which CONSULTANT will render in writing within a reasonable time. Written notice of each such claim, dispute and other matter will be delivered to CONSULTANT promptly (but in no event later than thirty days) after the occurrence of the event giving rise thereto, and written supporting data will be submitted to CONSULTANT within sixty days after such occurrence unless CONSULTANT allows an additional period of time to ascertain more accurate data in support of the claim.

8.12 Limitations on CONSULTANT's Responsibilities

8.12.1 CONTRACTOR, Supplier, or Surety

Neither CONSULTANT'S authority to act under this Article 8 or elsewhere in the Contract Documents nor any decision made by CONSULTANT in good faith either to exercise or not exercise such authority shall give rise to any duty or responsibility of CONSULTANT to CONTRACTOR, any Subcontractor, any Supplier, or any other person or organization performing any of the Work, or to any surety for any of them.

8.12.2 To Evaluate the Work

Whenever in the Contract Documents the terms "as ordered", "as directed", "as required", "as allowed", "as approved" or terms of like effect or import are used, or the adjectives "reasonable", "suitable", "acceptable", "proper", or "satisfactory" or adjectives or like "effect" or "import" are used to describe a requirement, direction, review or judgment of CONSULTANT as to the Work, it is intended that such requirement, direction, review or judgment will be solely to evaluate the Work for compliance with the Contract Documents (unless there is a specific statement indicating otherwise). The use of any such term or adjective shall not be effective to assign CONSULTANT any duty or authority to supervise or direct the furnishing or performance of the Work or any duty or authority to undertake responsibility contrary to the provisions of paragraph 8.12.3 or 8.12.4.

8.12.3 CONTRACTOR'S Means, Methods, Etc.

CONSULTANT will not be responsible for CONTRACTOR'S means, methods, techniques, sequences or procedures of construction, or the safety precautions and programs incident thereto, and CONSULTANT will not be responsible for CONTRACTOR'S failure to perform or furnish the Work in accordance with the Contract Documents.

8.12.4 Acts of Omissions of CONTRACTOR

CONSULTANT will not be responsible for the acts or omissions of CONTRACTOR or of any Subcontractor, any Supplier, or of any other person or organization performing or furnishing any of the Work.

9. **CHANGES IN THE WORK**

9.1 **OWNER May Order Change**

Without invalidating the Agreement and without notice to any surety, OWNER may, at any time or from time to time, order additions, deletions or revisions in the Work; these will be authorized by a Change Order. Upon receipt of such notice, CONTRACTOR shall promptly proceed with the Work involved which will be performed under the applicable conditions of the Contract Documents (except as otherwise specifically provided).

9.2 **Claims**

Claims for an increase or decrease in the Contract Price or an extension or shortening of the Contract Time that should be allowed as a result of a Change Order will be settled as provided for in Article 10 or Article 11.

9.3 **Work Not in Contract Documents**

CONTRACTOR shall not be entitled to an increase in the Contract Price or an extension of the Contract Time with respect to any Work performed that is not required by the Contract Documents as amended, modified and supplemented as provided in paragraph 3.4, except in the case of an emergency and except in the case of uncovering Work as provided in paragraph 12.3.4.

9.4 **Change Orders**

OWNER and CONTRACTOR shall execute appropriate Change Orders covering:

9.4.1 changes in the Work which are ordered by OWNER pursuant to paragraph 9.1, are required because of acceptance of defective Work under paragraph 12.7 or corrective defective Work under paragraph 12.8, or are agreed to by the parties;

9.4.2 changes in the Contract Price or Contract Time which are agreed to by the parties; and

9.4.3 changes in the Contract Price or Contract Time which embody the substance of any written decision rendered by CONSULTANT pursuant to paragraph 8.11; provided that, in lieu of executing any such Change Order, an appeal may be taken from any such decision in accordance with the provisions of the Contract Documents and applicable Laws and REGULATIONS, but during any such appeal, CONTRACTOR shall carry on the Work and adhere to the progress schedule as provided in paragraph 5.16.

9.5 Notice of Change

If notice of any change affecting the general scope of the Work or the provisions of the Contract Documents (including, but not limited to, Contract Price or Contract Time) is required by the provisions of any Bond to be given to a surety, the giving of any such notice will be CONTRACTOR'S responsibility, and the amount of each applicable Bond will be adjusted accordingly.

10. CHANGE OF CONTRACT PRICE

10.1 Total Compensation

The Contract Price constitutes the total compensation (subject to authorized adjustments) payable to CONTRACTOR for performing the Work. All duties, responsibilities and obligations assigned to or undertaken by CONTRACTOR shall be at his expense without change in the Contract Price.

10.2 Claim for Increase or Decrease in Price

The Contract Price may only be changed by a Change Order. Any claim for an increase or decrease in the Contract Price shall be based on written notice delivered by the CONTRACTOR to the CONSULTANT promptly (but in no event later than thirty days) after the occurrence of the event giving rise to the claim and stating the general nature of the claim. Notice of the amount of the claim with supporting data shall be delivered within sixty days after such occurrence (unless CONSULTANT allows an additional period of time to ascertain more accurate data in support of the claim) and shall be accompanied by CONTRACTOR'S written statement that the amount claimed covers all known amounts (direct, indirect, and consequential) to which the CONTRACTOR is entitled as a result of the occurrence of said event.

10.3 Value of Work

The value of any Work covered by a Change Order or of any claim for an increase or decrease in the Contract Price shall be determined in one of the following ways:

10.3.1 Unit Prices

Where the Work involved is covered by unit prices contained in the Contract Documents, by application of unit prices to the quantities of the items involved (subject to the provisions of paragraphs 10.9.1. through 10.9.3, inclusive).

10.3.2 Lump Sum

By mutual acceptance of a lump sum (which may include an allowance for overhead and profit not necessarily in accordance with paragraph 10.6.2.1).

10.3.3 Cost Plus Fee

On the basis of the Cost of the Work (determined as provided in paragraphs 10.4 and 10.5) plus a CONTRACTOR'S fee for overhead and profit (determined as provided in paragraphs 10.6 and 10.7).

10.4 Cost of the Work

The term Cost of the Work means the sum of all costs necessarily incurred and paid by CONTRACTOR in the proper performance of the Work. Except as otherwise may be agreed to in writing by OWNER, such costs shall be in amounts no higher than those prevailing in the locality of the Project; shall include only the following items; and shall not include any of the costs itemized in paragraph 10.5:

10.4.1 Payroll Costs

Payroll costs for employees in the direct employ of CONTRACTOR in the performance of the Work under schedules of job classifications agreed upon by OWNER and CONTRACTOR. Payroll costs for employees not employed full time on the Work shall be apportioned on the basis of their time spent on the Work. Payroll costs shall include, but not be limited to, salaries and wages plus the cost of fringe benefits which shall include social security contributions, unemployment, excise and payroll taxes, workers' or workmen's compensation, health and retirement benefits, bonuses, sick leave, vacation and holiday pay applicable thereto. Such employees shall include superintendents and foremen at the site. The expenses of performing Work after regular working hours, on Saturday, Sunday or legal holidays, shall be included in the above to the extent authorized by OWNER.

10.4.2 Materials and Equipment Costs

Cost of all materials and equipment furnished and incorporated in the Work, including costs of transportation and storage thereof, and Suppliers' field services required in connection therewith. All cash discounts shall accrue to CONTRACTOR unless OWNER deposits funds with CONTRACTOR with which to make payments, in which case the cash discounts shall accrue to OWNER. All trade discounts, rebates and refunds and all returns from sale of surplus materials and equipment shall accrue to OWNER, and CONTRACTOR shall make provisions so that they may be obtained.

10.4.3 Subcontractor Costs

Payments made by CONTRACTOR to the Subcontractors for Work performed by Subcontractors. If required by OWNER, CONTRACTOR shall obtain competitive bids from Subcontractors acceptable to CONTRACTOR and shall deliver such bids to OWNER who will then determine, with the advice of CONSULTANT, which bids will be accepted. If a subcontract provides that the Subcontractor is to be paid on the basis of Cost of the Work Plus a Fee, the Subcontractor's Cost of the Work shall be determined in the same manner as CONTRACTOR'S Cost of the Work. All subcontracts shall be subject to the other provisions of the Contract Documents insofar as applicable.

10.4.4 Special Consultant Costs

Costs of special consultants (including but not limited to engineers, architects, testing laboratories, surveyors, attorneys and accountants) employed for services specifically related to the Work.

10.4.5 Supplemental Costs

10.4.5.1 The proportion of necessary transportation, travel and subsistence expenses of CONTRACTOR'S employees incurred in discharge of duties connected with the Work.

10.4.5.2 Cost, including transportation and maintenance, of all materials, supplies, equipment, machinery, appliances, office and temporary facilities at the site and hand tools not owned by the workers, which are consumed in the performance of the Work, and cost less market value of such items used but not consumed which remain the property of CONTRACTOR.

10.4.5.3 Rentals of all construction equipment and machinery and the parts thereof whether rented from CONTRACTOR or others in accordance with rental agreements approved by OWNER with the advice of CONSULTANT, and the costs of transportation, loading, unloading, installation, dismantling and removal shall be in accordance with terms of said rental agreements. The rental of any such equipment, machinery or parts shall cease when the use thereof is no longer necessary for the Work.

10.4.5.4 Sales, consumer, use or similar taxes related to the Work, and for which CONTRACTOR is liable, imposed by Laws and Regulations.

10.4.5.5 Deposits lost for causes other than negligence of CONTRACTOR, any Subcontractor or anyone directly or indirectly employed by any of them or for whose acts any of them may be liable, and royalty payments and fees for permits and licenses.

10.4.5.6 Losses and damages (and related expenses), not compensated by insurance or otherwise, to the Work or otherwise sustained by CONTRACTOR in connection with the performance and furnishing of the Work (except losses and damages within the deductible amounts of property insurance established by OWNER), provided they have resulted from causes other than the negligence of CONTRACTOR, any Subcontractor, or anyone directly or indirectly employed by any of them or for whose acts any of them may be liable. Such losses shall include settlements made with the written consent and approval of OWNER. No such losses, damages and expenses shall be included in the Cost of the Work for the purpose of determining CONTRACTOR'S fee. If, however, any such loss or damage requires reconstruction and CONTRACTOR is placed in charge thereof, CONTRACTOR shall be paid a fee proportionate to that stated in paragraph 10.6.2 for services.

10.4.5.7 The cost of utilities, fuel and sanitary facilities at the site.

10.4.5.8 Minor expenses such as telegrams, long distance telephone calls, telephone service at the site, expressage and similar petty cash items in connection with the Work.

10.4.5.9 Cost of premiums for additional Bonds and insurance required because of changes in the Work and premiums for property insurance coverage within the limits of the deductible amounts established by OWNER.

10.5 Not to Be Included in Cost of the Work

The term Cost of the Work shall not include any of the following:

10.5.1 Costs of Officers and Executives

Payroll costs and other compensation of CONTRACTOR'S officers, executives, principals (of partnership and sole proprietorships), general managers, engineers, architects, estimators, attorneys, auditors, accountants, purchasing and contracting agents, expeditors, timekeepers, clerks and other personnel employed by CONTRACTOR whether at the site or in CONTRACTOR'S principal or a branch office for general administration of

the Work and not specifically included in the agreed upon schedule of job classifications referred to in paragraph 10.4.1 or specifically covered by paragraph 10.4.4 - all of which are to be considered administrative costs covered by the CONTRACTOR'S fee.

10.5.2 Principal Office

Expenses of CONTRACTOR'S principal and branch offices other than CONTRACTOR'S office at the site.

10.5.3 Capital Expense

Any part of CONTRACTOR'S capital expenses, including interest on CONTRACTOR'S capital employed for the Work and charges against CONTRACTOR for delinquent payments.

10.5.4 Bonds and Insurance

Cost of premiums for all Bonds and for all insurance whether or not CONTRACTOR is required by the Contract Documents to purchase and maintain the same (except for the cost of premiums covered by subparagraph 10.4.5.9 above).

10.5.5 Costs Due to Negligence

Costs due to the negligence of CONTRACTOR, any Subcontractor, or anyone directly or indirectly employed by any of them or for whose acts any of them may be liable, including but not limited to, the correction of defective Work, disposal of materials or equipment wrongly supplied and making good any damage to property.

10.5.6 Other Costs

Other overhead or general expense costs of any kind and the costs of any item not specifically and expressly included in paragraph 10.4.

10.6 Contractor's Fee

The CONTRACTOR'S Fee allowed to CONTRACTOR for overhead and profit shall be determined as follows:

10.6.1 a mutually acceptable fixed fee; or if none can be agreed upon,

10.6.2 a fee based on the following percentages of the various portions of the Cost of the Work:

10.6.2.1 for costs incurred under paragraphs 10.4.1 and 10.4.2, the CONTRACTOR'S fee shall be fifteen percent;

10.6.2.2 for costs incurred under paragraph 10.4.3, the CONTRACTOR'S fee shall be five percent; and if a subcontract is on the basis of Cost of the Work Plus a fee, the maximum allowable to CONTRACTOR on account of overhead and profit of all Subcontractors shall be fifteen percent;

10.6.2.3 no fee shall be payable on the basis of costs itemized under paragraphs 10.4.4, 10.4.5 and 10.5;

10.6.2.4 the amount of credit to be allowed by CONTRACTOR to OWNER for any such change which results in a net decrease in cost will be the amount of the actual net decrease plus a deduction in CONTRACTOR'S Fee by an amount equal to ten percent of the net decrease; and

10.6.2.5 when both additions and credits are involved in any one change, the adjustment in CONTRACTOR'S fee shall be computed on the basis of the net change in accordance with paragraphs 10.6.2.1 through 10.6.2.4, inclusive.

10.7 Itemized Cost Breakdown

Whenever the cost of any Work is to be determined pursuant to paragraph 10.4 or 10.5, CONTRACTOR will submit in form acceptable to CONSULTANT an itemized cost breakdown together with supporting data.

10.8 Cash Allowances

It is understood that CONTRACTOR has included in the Contract Price all allowances so named in the Contract Documents and shall cause the Work so covered to be done by such Subcontractors or Suppliers and for such sums within the limit of the allowances as may be acceptable to CONSULTANT, CONTRACTOR agrees that:

10.8.1 Materials and Equipment

The allowances include the cost to CONTRACTOR (less any applicable trade discounts) of materials and equipment required by the allowances to be delivered at the site, and all applicable taxes; and

10.8.2 Other Costs

CONTRACTOR'S costs for unloading and handling on the site, labor, installation costs, overhead, profit and other expenses contemplated for the allowances have been included in the Contract Price and not in the allowances. No demand for additional payment on account of any thereof will be valid.

10.8.3 Change Order

Prior to final payment, an appropriate Change Order will be issued as recommended by CONSULTANT to reflect actual amounts due CONTRACTOR on account of Work covered by allowances, and the Contract Price shall be correspondingly adjusted.

10.9 Unit Price Work

10.9.1 General

Where the Contract Documents provide that all or part of the Work is to be Unit Price Work, initially the Contract Price will be deemed to include for all Unit Price Work an amount equal to the sum of the established unit prices for each separately identified item of Unit Price Work times the estimated quantity of each item as indicated in the Agreement. The estimated quantities of items of Unit Price Work are not guaranteed and are solely for the purpose of comparison of Bids and determining an initial Contract Price. Determinations of the actual quantities and classifications of Unit Price Work performed by CONTRACTOR will be made by CONSULTANT in accordance with Paragraph 8.10.

10.9.2 Overhead and Profit

Each unit price will be deemed to include an amount considered by CONTRACTOR to be adequate to cover CONTRACTOR'S overhead and profit for each separately identified item.

10.9.3 Claim for Increase in Unit Price

Where the quantity of any item of Unit Price Work performed by CONTRACTOR differs materially and significantly from the estimated quantity of such item indicated in the Agreement and there is no corresponding adjustment with respect to any other item of Work and if CONTRACTOR believes that CONTRACTOR has incurred additional expense as a result thereof, CONTRACTOR may make a claim for an increase in the Contract Price in accordance with Article 10.

11. CHANGE OF CONTRACT TIME

11.1 Change Order

The Contract Time may only be changed by a Change Order. Any claim for an extension or shortening of the Contract Time shall be based on written notice delivered to CONSULTANT promptly (but in no event later than thirty days) after the occurrence of the event giving rise to the claim and stating the general nature of the claim. Notice of the extent of the claim with supporting data shall be delivered within sixty days after such occurrence (unless CONSULTANT allows an additional period of time to ascertain more accurate data in support of the claim) and shall be accompanied by the claimant's written statement that the adjustment claimed is the entire adjustment to which the claimant has reason to believe it is entitled as a result of the occurrence of said event. All claims for adjustment in the Contract Time shall be determined by CONSULTANT in accordance with paragraph 8.11. No claim for an adjustment in the Contract Time will be valid if not submitted in accordance with the requirements of this paragraph 11.1.

11.2 Justification for Time Extensions

The Contract Time will be extended in an amount equal to time lost due to delays beyond the control of CONTRACTOR if a claim is made therefore as provided in paragraph 11.1. Such delays shall include, but not be limited to, acts or neglect by OWNER or others performing additional work as contemplated by Article 6, or to fires, floods, labor disputes, epidemics, abnormal weather conditions or acts of God.

11.3 Time Limits

All time limits stated in the Contract Documents are of the essence of the Agreement. The provisions of this Article 11 shall not exclude recovery for damages (including but not limited to fees and charges of engineers, architects, attorneys and other professionals and court costs) for delay by either party.

12. WARRANTY AND GUARANTEE; TESTS AND INSPECTIONS; CORRECTION, REMOVAL OR ACCEPTANCE OF DEFECTIVE WORK

12.1 Warranty and Guarantee

CONTRACTOR warrants and guarantees to OWNER and CONSULTANT that all Work will be in accordance with the Contract Documents and will not be defective. All defective Work, whether or not in place, may be rejected, corrected or accepted as provided in this Article 12.

12.2 Access to Work

CONSULTANT and CONSULTANT'S representatives, other representatives of OWNER, testing agencies and governmental agencies with jurisdictional interests will have access to the Work at reasonable times for their observation, inspecting and testing. CONTRACTOR shall provide proper and safe conditions for such access.

12.3 Tests and Inspections

12.3.1 Timely Notice

CONTRACTOR shall give CONSULTANT timely notice of readiness of the Work for all required inspections, tests or approvals.

12.3.2 Requirements and Responsibilities

The CONSULTANT may require such inspection and testing during the course of the Work as he/she deems necessary to ascertain and assure the integrity and acceptable quality of the materials incorporated and the work performed. Inspection presence may be either full-time or intermittent, and neither the presence nor absence at any time of the CONSULTANT or the INSPECTOR shall relieve the CONTRACTOR of sole responsibility for the acceptability and integrity of the Work or any part thereof.

The costs of sampling, testing, and inspection on-site to ascertain acceptability of the Work and materials will be borne by the OWNER except as otherwise provided. The OWNER will select a testing laboratory to perform such sampling and testing. Sampling and/or testing required by the CONTRACTOR or necessitated by failure of Work or materials to meet the above acceptability test shall be at the expense of the CONTRACTOR.

Inspection services may be performed by the employees of the OWNER or by others selected or designated by the OWNER or the CONSULTANT.

Sampling and/or testing required for manufacturing quality and/or process control, for certification that raw mineral materials or manufactured products are the quality specified in the contract, or to assure the acceptability for incorporation into the Work shall be borne by the CONTRACTOR or the material supplier.

Cost for inspection, sampling, testing, and approvals required by the laws or regulations of any public body having competent jurisdiction shall be borne by the CONTRACTOR or the material supplier.

Sampling and testing will be in accord with pertinent codes and regulations and with appropriate standards of the American Society of Testing Materials or other specified standards.

12.3.3 On-Site Construction Test and Other Testing

All inspections, tests or approvals other than those required by Laws or Regulations of any public body having jurisdiction shall be performed by organizations acceptable to OWNER and CONTRACTOR (or by CONSULTANT if so specified).

12.3.4 Covered Work

If any Work (including the work of others) that is to be inspected, tested or approved is covered without written concurrence of CONSULTANT, it must, if requested by CONSULTANT, be uncovered for observation. Such uncovering shall be at CONTRACTOR'S expense unless CONTRACTOR has given CONSULTANT timely notice of CONTRACTOR'S intention to cover the same and CONSULTANT has not acted with reasonable promptness in response to such notice.

12.3.5 CONTRACTOR'S Obligation

Neither observations by CONSULTANT nor inspections, tests or approvals by others shall relieve CONTRACTOR from CONTRACTOR'S obligations to perform the Work in accordance with the Contract Documents.

12.4 OWNER May Stop the Work

If the Work is defective, or CONTRACTOR fails to supply sufficient skilled workers or suitable materials or equipment, or fails to furnish or perform the Work in such a way that the completed Work will conform to the Contract Documents, OWNER may order CONTRACTOR to stop the Work, or any portion thereof, until the cause for such order has been eliminated; however, this right of OWNER to stop the Work shall not give rise to any duty on the part of OWNER to exercise this right for the benefit of CONTRACTOR or any other party.

12.5 Correction or Removal of Defective Work

If required by CONSULTANT, CONTRACTOR shall promptly, as directed, either correct all defective Work, whether or not fabricated, installed or completed, or, if the Work has been rejected by CONSULTANT, remove it from the site and replace it with non-defective Work. CONTRACTOR shall bear all direct, indirect and consequential costs of such correction or removal (including but not limited to fees and charges of engineers, architects, attorneys and other professionals) made necessary thereby.

12.6 One Year Correction Period

If within one year after the date of Completion or such longer period of time as may be prescribed by Laws or Regulations or by the terms of any applicable special guarantee required by the Contract Documents or by any specific provision of the Contract Documents, any Work is found to be defective, CONTRACTOR shall promptly, without cost to OWNER and in accordance with OWNER'S written instructions, either correct such defective Work, or, if it has been rejected by OWNER, remove it from the site and replace it with non-defective Work. If CONTRACTOR does not promptly comply with the terms of such instructions, or in an emergency where delay would cause serious risk of loss or damage, OWNER may have the defective Work corrected or the rejected Work removed and replaced, and all direct, indirect and consequential costs of such removal and replacement

(including but not limited to fees and charges of engineers, architects, attorneys and other professionals) will be paid by CONTRACTOR. In special circumstances where a particular item of equipment is placed in continuous service before Completion of all the Work, the correction period for that item may start to run from an earlier date if so provided in the Specifications or by Change Order.

12.7 Acceptance of Defective Work

If, instead of requiring correction or removal and replacement of defective Work, OWNER prefers to accept it, OWNER may do so. CONTRACTOR shall bear all direct, indirect and consequential costs attributable to OWNER'S evaluation of and determination to accept such defective Work (such costs to be approved by CONSULTANT as to reasonableness and to include but not be limited to fees and charges of engineers, architects, attorneys and other professionals).

12.8 OWNER May Correct Defective Work

If CONTRACTOR fails within a reasonable time after written notice of CONSULTANT to proceed to correct and to correct defective Work or to remove and replace rejected Work as required by CONSULTANT in accordance with paragraph 12.5, or if CONTRACTOR fails to perform the Work in accordance with the Contract Documents, or if CONTRACTOR fails to comply with any other provision of the Contract Documents, OWNER may, after seven days' written notice to CONTRACTOR, correct and remedy any such deficiency. In exercising the rights and remedies under this paragraph OWNER shall proceed expeditiously. To the extent necessary to complete corrective and remedial action, OWNER may exclude CONTRACTOR from all or part of the site, take possession of all or part of the Work, and suspend CONTRACTOR'S services related thereto, take possession of CONTRACTOR'S tools, appliances, construction equipment and machinery at the site and incorporate in the Work all materials and equipment stored at the site or for which OWNER has paid CONTRACTOR but which are stored elsewhere. CONTRACTOR shall allow OWNER, OWNER'S representatives, agents and employees such access to the site as may be necessary to enable OWNER to exercise the rights and remedies under this paragraph. All direct, indirect and consequential costs of OWNER in exercising such rights and remedies will be charged against CONTRACTOR in an amount approved as to reasonableness by CONSULTANT, and a Change Order will be issued incorporating the necessary revisions in the Contract Documents with respect to the Work; and OWNER shall be entitled to an appropriate decrease in the Contract Price. Such direct, indirect and consequential costs will include but not be limited to fees and charges of engineers, architects, attorneys and other professionals, all court costs and all costs of repair and replacement of work of others destroyed or damaged by correction, removal or replacement of CONTRACTOR'S defective Work. CONTRACTOR shall not be allowed an extension of the Contract Time because of any delay in performance of the Work attributable to the exercise by OWNER of OWNER'S rights and remedies hereunder.

13. PAYMENTS TO CONTRACTOR AND COMPLETION

13.1 Schedule of Values

The schedule of values established as provided in paragraph 2.8 will serve as the basis for progress payments and will be incorporated into a form of Application for Payment acceptable to CONSULTANT. Progress payments on account of Unit Price Work will be based on the number of units completed.

13.2 Application for Progress Payment

At least ten days before each progress payment is scheduled (but not more often than once a month), CONTRACTOR shall submit to CONSULTANT for review an Application for Payment filled out and signed by CONTRACTOR covering the Work completed as of the date of the Application and accompanied by such supporting documentation as is required by the Contract Documents. If payment is requested on the basis of materials and equipment not incorporated in the Work but delivered and suitably stored at the site or at another location agreed to in writing, the Application for Payment shall also be accompanied by a bill of sale, invoice or other documentation warranting that OWNER has received the materials and equipment free and clear of all liens, charges, security interests and encumbrances (which are hereinafter in these General Conditions referred to as "Liens") and evidence that the materials and equipment are covered by appropriate property insurance and other arrangements to protect OWNER'S interest therein, all of which will be satisfactory to OWNER. OWNER shall, within thirty (30) calendar days of presentation to him of an approved Application for Payment, pay CONTRACTOR the amount approved by CONSULTANT. Monthly progress payments shall be ninety (90) percent of the sum obtained by applying the respective bid unit prices to the approved estimated quantities of work completed by the Contractor during the preceding month. The remaining ten (10) percent will be held by the Owner, as retainage. At such time as the CONSULTANT deems appropriate - based on the quality of work performed, progress of cleanup, and other pertinent factors - the rate of retainage, or the total amount retained, may be reduced; although, any reduction in retainage, below the ten (10) percent level, is made solely at the CONSULTANT's discretion. All remaining retainage held will be included in the final payment to the Contractor.

13.2.1 Waivers of Mechanic's Lien

With each Application for Payment OWNER may require CONTRACTOR to submit waivers of mechanic's lien from entities lawfully entitled to file a mechanic's lien arising out of the Contract and related to the Work covered by the payment.

13.2.1.1 Requirement for waivers of Mechanic's Lien on Partial Applications for Payment will be determined and communicated at the Preconstruction Conference.

13.2.1.2 Submit partial waivers on each item for amount requested in previous application, after deduction for retainage, on each item.

13.2.1.3 When an application shows completion of an item, submit conditional final or full waivers.

13.2.1.4 Owner reserves the right to designate which entities involved in the Work must submit waivers.

13.2.1.5 Waiver Forms: Submit executed waivers of lien on forms acceptable to Owner.

13.3 CONTRACTOR'S Warranty of Title

CONTRACTOR warrants and guarantees that title to all Work, materials and equipment covered by any Application for Payment, whether incorporated in the Project or not, will pass to OWNER no later than the time of payment free and clear of all Liens.

13.4 Review of Applications for Progress Payment

13.4.1 Submission of Application for Payment

CONSULTANT will, after receipt of each Application for Payment, either indicate in writing a recommendation of payment and present the Application to OWNER, or return the Application to CONTRACTOR indicating in writing CONSULTANT'S reasons for refusing to recommend payment. In the latter case, CONTRACTOR may make the necessary corrections and resubmit the Application.

13.4.2 CONSULTANT'S Recommendation

CONSULTANT may refuse to recommend the whole or any part of any payment, if, in CONSULTANT'S opinion, it would be incorrect to make such representations to OWNER. CONSULTANT may also refuse to recommend any such payment, or, because of subsequently discovered evidence or the results of subsequent inspections or tests, nullify any such payment previously recommended, to such extent as may be necessary in CONSULTANT'S opinion to protect OWNER from loss because:

13.4.2.1 the Work is defective, or completed Work has been damaged requiring correction or replacement;

13.4.2.2 the Contract Price has been reduced by Written Amendment or Change Order;

13.4.2.3 OWNER has been required to correct defective Work or complete Work in accordance with paragraph 12.8; or

13.4.2.4 of CONSULTANT's actual knowledge of the occurrence of any of the events enumerated in paragraphs 14.2.1 through 14.2.9 inclusive.

13.5 Partial Utilization

OWNER at any time may request CONTRACTOR in writing to permit OWNER to use any such part of the Work which OWNER believes to be ready for its intended use and has been completed. If CONTRACTOR agrees, CONTRACTOR will certify to OWNER that said part of the Work is complete and request that a Certificate of Completion be issued for that part of the Work.

13.6 Final Inspection

Upon written notice from CONTRACTOR that the entire Work or an agreed portion thereof is complete, CONSULTANT will make a final inspection with CONTRACTOR and will notify CONTRACTOR in writing of all particulars in which this inspection reveals that the Work is incomplete or defective. CONTRACTOR shall immediately take such measures as are necessary to remedy such deficiencies.

13.7 Final Application for Payment

After CONTRACTOR has completed all such corrections to the satisfaction of CONSULTANT and delivered all maintenance and operating instructions, schedules, guarantees, Bonds, certificates of inspection, marked-up record documents (as provided in paragraph 5.14) and other documents - all as required by the Contract Documents, and after CONSULTANT has indicated that the Work is acceptable (subject to the provisions of paragraph 13.10), CONTRACTOR may make application for final payment following the procedure for progress payments. The final Application for Payment shall be accompanied by all documentation called for in the Contract Documents, together with complete and legally effective releases or waivers (satisfactory to OWNER) of all Liens arising out of or filed in connection with the Work. In lieu thereof and as approved by OWNER, CONTRACTOR may furnish receipts or releases in full; an affidavit of CONTRACTOR that the releases and receipts include all labor, services, material and equipment for which a Lien could be filed, and that all payrolls, material and equipment bills, and other indebtedness connected with the Work for which OWNER or OWNER'S property might in any way be responsible, have been paid or otherwise satisfied; and consent of the surety, if any, to final payment. If any Subcontractor or Supplier fails to

furnish a release or receipt in full, CONTRACTOR may furnish a Bond or other collateral satisfactory to OWNER to indemnify OWNER against any Lien.

13.8 Final Payment and Acceptance

13.8.1 CONSULTANT'S Approval

If, on the basis of CONSULTANT'S observation of the Work during construction and final inspection, and CONSULTANT'S review of the final Application for Payment and accompanying documentation - all as required by the Contract Documents, CONSULTANT is satisfied that the Work has been completed and CONTRACTOR'S other obligations under the Contract Documents have been fulfilled, CONSULTANT will, after receipt of the final Application for Payment, indicate in writing CONSULTANT'S recommendation of payment and present the Application to OWNER for payment. Thereupon CONSULTANT will give written notice to OWNER and CONTRACTOR that the Work is acceptable, subject to the provisions of paragraph 13.10. Otherwise, CONSULTANT will return the Application to CONTRACTOR, indicating in writing the reasons for refusing to recommend final payment, in which case CONTRACTOR shall make the necessary corrections and resubmit the Application.

13.8.2 Delay in Completion of Work

If, through no fault of CONTRACTOR, final completion of the Work is significantly delayed, OWNER shall, upon receipt of CONTRACTOR'S final Application for Payment and recommendation of CONSULTANT, and without terminating the Agreement, make payment of the balance due for that portion of the Work fully completed and accepted. If the remaining balance to be held by OWNER for Work not fully completed or corrected is less than the retainage stipulated in the Agreement, and if Bonds have been furnished as required in paragraph 10 of Part II, Information for Bidders, the written consent of the surety to the payment of the balance due for that portion of the Work fully completed and accepted shall be submitted by CONTRACTOR to CONSULTANT with the Application for such payment. Such payment shall be made under the terms and conditions governing final payment, except that it shall not constitute a waiver of claims.

13.9 CONTRACTOR'S Continuing Obligation

CONTRACTOR'S obligation to perform and complete the Work in accordance with the Contract Documents shall be absolute. Neither recommendation of any progress or final payment by CONSULTANT, nor the issuance of a certificate of Completion, nor any payment by OWNER to CONTRACTOR under the Contract Documents, nor any use or occupancy of the Work or any part thereof by OWNER, nor any act of acceptance by OWNER nor any failure to do so, nor any review and approval of a Shop Drawing or sample submission, nor any correction of defective Work by OWNER will constitute an acceptance of Work not in accordance with the Contract Documents or a release of CONTRACTOR'S obligation to perform the

Work in accordance with the Contract Documents (except as provided in paragraph 13.10).

13.10 Waiver of Claims

The making and acceptance of final payment will constitute:

13.10.1 a waiver of all claims by OWNER against CONTRACTOR, except claims arising from unsettled Liens, from defective Work appearing after final inspection or from failure to comply with the Contract Documents or the terms of any special guarantees specified therein; however, it will not constitute a waiver by OWNER of any rights in respect of CONTRACTOR'S continuing obligations under the Contract Documents; and

13.10.2 a waiver of all claims by CONTRACTOR against OWNER other than those previously made in writing and still unsettled.

14. SUSPENSION OF WORK AND TERMINATION

14.1 OWNER May Suspend Work

OWNER may, at any time and without cause, suspend the Work or any portion thereof for a period of not more than ninety days by notice in writing to CONTRACTOR and CONSULTANT which will fix the date on which Work will be resumed. CONTRACTOR shall resume the Work on the date so fixed. CONTRACTOR shall be allowed an increase in the Contract Price or an extension of the Contract Time, or both, directly attributable to any suspension if CONTRACTOR makes an approved claim therefor as provided in Articles 10 and 11.

14.2 OWNER May Terminate

The OWNER may terminate the Work upon the occurrence of any one or more of the following events:

14.2.1 if CONTRACTOR commences a voluntary case under any chapter of the Bankruptcy Code (Title 11, United States Code), as now or hereafter in effect, or if CONTRACTOR takes any equivalent or similar action by filing a petition or otherwise under any other federal or state law in effect at such time relating to the bankruptcy or insolvency;

14.2.2 if a petition is filed against CONTRACTOR under any chapter of the Bankruptcy Code as now or hereafter in effect at the time of filing, or if a petition is filed seeking any such equivalent or similar relief against CONTRACTOR under any other federal or state law in effect at the time relating to bankruptcy or insolvency;

14.2.3 if CONTRACTOR makes a general assignment for the benefit of creditors;

14.2.4 if a trustee, receiver, custodian or agent of CONTRACTOR is appointed under applicable law or under contract, whose appointment or authority to take charge of property of CONTRACTOR is for the purpose of enforcing a Lien against such property or for the purpose of general administration of such property for the benefit of CONTRACTOR'S creditors;

14.2.5 if CONTRACTOR admits in writing an inability to pay its debts generally as they become due;

14.2.6 if CONTRACTOR persistently fails to perform the Work in accordance with the Contract Documents (including, but not limited to, failure to supply sufficient skilled workers or suitable materials or equipment or failure to adhere to the progress schedule established under paragraph 2.8 as revised from time to time);

14.2.7 if CONTRACTOR disregards Laws or Regulations of any public body having jurisdiction;

14.2.8 if CONTRACTOR disregards the authority of CONSULTANT, or

14.2.9 if CONTRACTOR otherwise violates in any substantial way any provisions of the Contract Documents;

OWNER may, after giving CONTRACTOR (and the surety) seven days' written notice and to the extent permitted by Laws and Regulations, terminate the services of CONTRACTOR, exclude CONTRACTOR from the site and take possession of the Work and of all CONTRACTOR'S tools, appliances, construction equipment and machinery at the site and use the same to the full extent they could be used by CONTRACTOR (without liability to CONTRACTOR for trespass or conversion), incorporate in the Work all materials and equipment stored at the site or for which OWNER has paid CONTRACTOR but which are stored elsewhere, and finish the Work as OWNER may deem expedient. In such case CONTRACTOR shall not be entitled to receive any further payment until the Work is finished. If the unpaid balance of the Contract Price exceeds the direct, indirect and consequential costs of completing the Work (including but not limited to fees and charges of engineers, architects, attorneys and other professionals and court and arbitration costs) such excess will be paid to CONTRACTOR. If such costs exceed such unpaid balance, CONTRACTOR shall pay the difference to OWNER. Such costs incurred by OWNER will be approved as to reasonableness by CONSULTANT and incorporated in a Change Order,

but when exercising any rights or remedies under this paragraph OWNER shall not be required to obtain the lowest price for the Work performed.

14.2.10 If safety violations are observed and brought to the Contractors attention and Contractor fails to take immediate corrective measures any repeat of similar safety violations, Owner will order an immediate termination of contract. Note: it is the Contractor's responsibility to know proper safety measures as they pertain to construction and OSHA.

14.2.11 This contract may be canceled by either party thirty (30) days after delivery by canceling party of written notice of intent to cancel to the other contracting party.

14.2.12 This contract may be canceled by the Lexington-Fayette Urban County Government if it is determined that the Bidder has failed to perform under the terms of this agreement, such cancellation to be effective upon receipt of written notice of cancellation by the Bidder.

14.3 CONTRACTOR'S Services Terminated

Where CONTRACTOR'S services have been so terminated by OWNER, the termination will not affect any rights or remedies of OWNER against CONTRACTOR then existing or which may thereafter accrue. Any retention or payment of moneys due CONTRACTOR by OWNER will not release CONTRACTOR from liability.

14.4 Payment After Termination

Upon seven days' written notice to CONTRACTOR, OWNER may, without cause and without prejudice to any other right or remedy, elect to abandon the Work and terminate the Agreement. In such case, CONTRACTOR shall be paid for all Work executed and any expense sustained plus reasonable termination expenses, which will include, but not be limited to, direct, indirect and consequential costs (including, but not limited to, fees and charges of engineers, architects, attorneys and other professionals and court and arbitration costs).

14.5 CONTRACTOR May Stop Work or Terminate

If, through no act or fault of CONTRACTOR, the Work is suspended for a period of more than ninety days by OWNER or under an order of court or other public authority, or CONSULTANT fails to act on any Application for Payment within sixty days after it is submitted, or OWNER fails for sixty days to pay CONTRACTOR any sum finally determined to be due, then CONTRACTOR may, upon seven days' written notice to OWNER and CONSULTANT, terminate the Agreement and recover from OWNER payment for all Work executed and any expense sustained plus reasonable termination expenses. In addition and in lieu of terminating the Agreement, if CONSULTANT has failed to act on an Application for Payment or OWNER has failed to make any payment as aforesaid, CONTRACTOR may upon seven days' written notice to OWNER and

CONSULTANT stop the Work until payment of all amounts then due. The provisions of this paragraph shall not relieve CONTRACTOR of the obligations under paragraph 5.16 to carry on the Work in accordance with the progress schedule and without delay during disputes and disagreements with OWNER.

15. MISCELLANEOUS

15.1 Claims for Injury or Damage

Should OWNER or CONTRACTOR suffer injury or damage to person or property because of any error, omission or act of the other party or of any of the other party's employees or agents or others for whose acts the other party is legally liable, claim will be made in writing to the other party within a reasonable time of the first observance of such injury or damage. The provisions of this paragraph 15.1 shall not be construed as a substitute for or a waiver of the provisions of any applicable statute of limitations or repose.

15.2 Non-Discrimination in Employment

The CONTRACTOR shall comply with the following requirements prohibiting discrimination:

15.2.1 That no person (as defined in KRS 344.010) shall bid on Lexington-Fayette Urban County Government construction projects, or bid to furnish materials or supplies to the Lexington-Fayette Urban County Government, if, within six months prior to the time of opening of bids, said person shall have been found, by declaratory judgment action in Fayette Circuit Court, to be presently engaging in an unlawful practice, as hereinafter defined. Such declaratory judgment action may be brought by an aggrieved individual or upon an allegation that an effort at conciliation pursuant to KRS 344.200 has been attempted and failed, by the Lexington-Fayette County Human Rights Commission.

15.2.2 That it is an unlawful practice for an employer:

15.2.2.1 to fail or refuse to hire, or to discharge any individual or otherwise to discriminate against an individual, with respect to his compensation, terms, conditions, or privileges of employment, because of such individual's race, color, religion, sex, age, or national origin; or

15.2.2.2 to limit, segregate or classify his employees in any way which would deprive or tend to deprive an individual of employment opportunities or otherwise adversely affect his status as an employee because of such individual's sex, race, color, religion, age, or national origin.

15.2.3 That it is an unlawful practice for an employer, labor organization, or joint-labor management committee controlling apprenticeship or other training or retraining, including on-the-job training programs to discriminate against an individual because of his race, color, religion, sex, age, or national origin in admission to, or employment in, any program established to provide apprenticeship or other training.

15.2.4 That a copy of this Ordinance shall be furnished all suppliers and made a part of all bid specifications.

15.2.5 This Ordinance shall take effect after it is signed, published and recorded, as required by law.

15.3 Temporary Street Closing or Blockage

The CONTRACTOR will notify the CONSULTANT at least 72 hours prior to making any temporary street closing or blockage. This will permit orderly notification to all concerned public agencies. Specific details and restrictions on street closure or blockage are contained in the Special Conditions.

15.4 Percentage of Work Performed by prime CONTRACTOR

The CONTRACTOR shall perform on site, and with its own organization, Work equivalent to at least fifty (50%) percent of the total amount of Work to be performed under the Contract. This percentage may be reduced by a supplemental agreement to this Contract if, during performing the Work, the CONTRACTOR requests a reduction and the CONSULTANT determines that the reduction would be to the advantage of the OWNER.

15.5 Clean-up

Cleanup shall progress, to the greatest degree practicable, throughout the course of the Work. The Work will not be considered as completed, and final payment will not be made, until the right-of-way and all ground occupied or affected by the Contractor in connection with the Work has been cleared of all rubbish, equipment, excess materials, temporary structures, and weeds. Rubbish and all waste materials of whatever nature shall be disposed of, off of the project site, in an acceptable manner. All property, both public and private, which has been damaged in the prosecution of the Work, shall be restored in an acceptable manner. All areas shall be draining, and all drainage ways shall be left unobstructed, and in such a condition that drift will not collect or scour be induced.

15.6 General

The duties and obligations imposed by these General Conditions and the rights and remedies available hereunder to the parties hereto, and, in particular but without limitation, the warranties, guarantees and obligations imposed upon CONTRACTOR by paragraphs 12.1, 12.3.5, 13.3, and 15.2 and all of the rights and remedies available to OWNER and CONSULTANT thereunder, are in addition to, and are not to be construed in any way as a limitation of, any rights and remedies

available to any or all of them which are otherwise imposed or available by Laws or Regulations, by special warranty or guarantee or by other provisions of the Contract Documents, and the provisions of this paragraph will be as effective as if repeated specifically in the Contract Documents in connection with each particular duty, obligation, right and remedy to which they apply. All representations, warranties and guarantees made in the Contract Documents will survive final payment and termination or completion of the Agreement.

15.7 Debris Disposal

For all LFUCG projects any trash, construction demolition debris, yard waste, dirt or debris of any kind that is removed from the project site must be disposed of in accordance with local, state, and federal regulations. The disposal site or facility must be approved in advance by the LFUCG and disposal documentation is required. The Contractor will be responsible for payment of any fines associated with improper disposal of material removed from the project site.

END OF SECTION

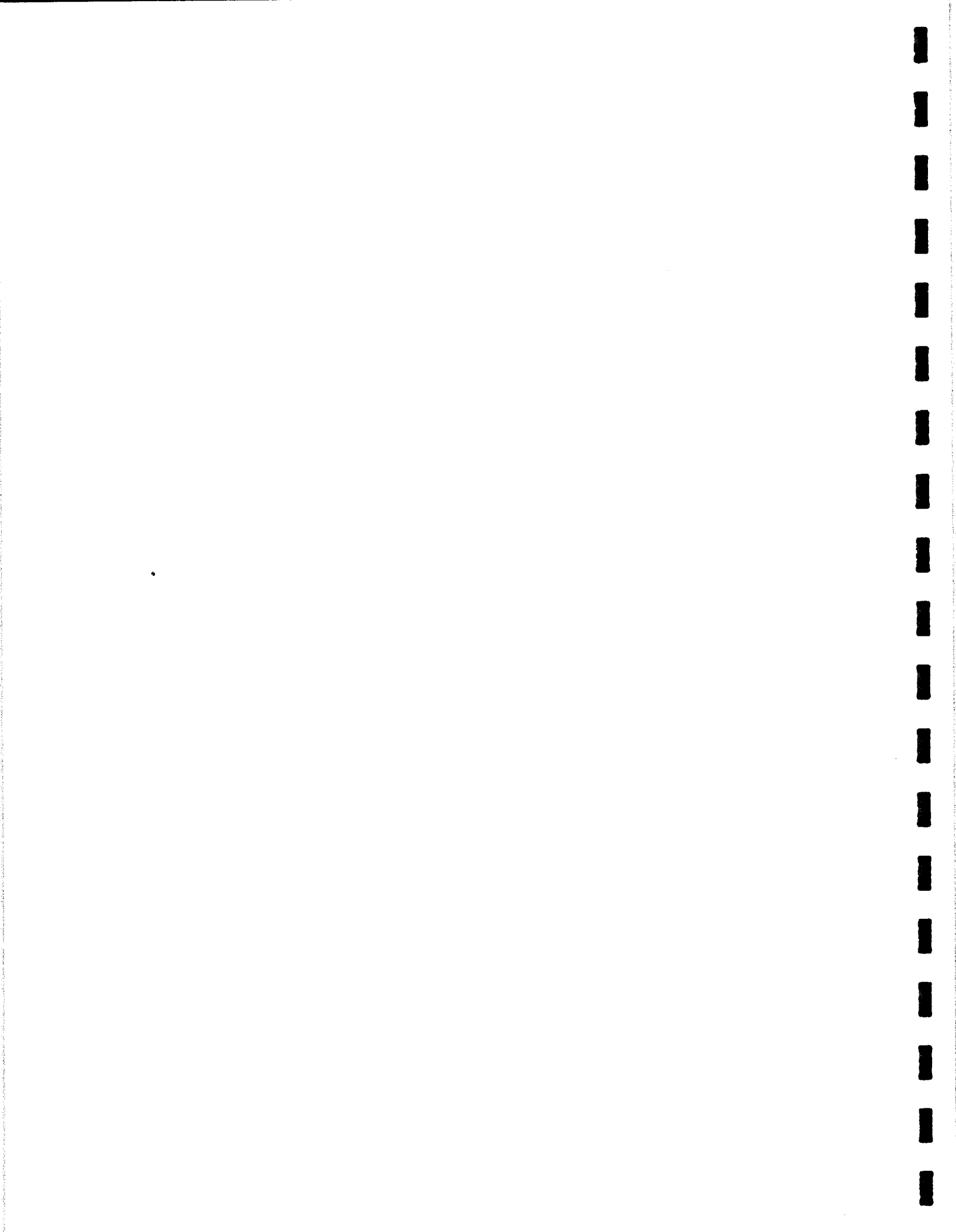

PART V
SPECIAL CONDITIONS
INDEX

- 1 BLASTING
- 2 RISK MANAGEMENT PROVISIONS –
INSURANCE AND INDEMNIFICATION
- 3 WAGE SCALE (if applicable)
- 4 WEATHER RELATED DELAYS



1. BLASTING – not applicable.

2. RISK MANAGEMENT PROVISIONS
INSURANCE AND INDEMNIFICATION

INDEMNIFICATION AND HOLD HARMLESS PROVISION

(1) It is understood and agreed by the parties that Contractor hereby assumes the entire responsibility and liability for any and all damages to persons or property caused by or resulting from or arising out of any act or omission on the part of Contractor or its employees, agents, servants, owners, principals, licensees, assigns or subcontractors of any tier (hereinafter "CONTRACTOR") under or in connection with this agreement and/or the provision of goods or services and the performance or failure to perform any work required thereby.

(2) CONTRACTOR shall indemnify, save, hold harmless and defend the Lexington-Fayette Urban County Government and its elected and appointed officials, employees, agents, volunteers, and successors in interest (hereinafter "LFUCG") from and against all liability, damages, and losses, including but not limited to, demands, claims, obligations, causes of action, judgments, penalties, fines, liens, costs, expenses, interest, defense costs and reasonable attorney's fees that are in any way incidental to or connected with, or that arise or are alleged to have arisen, directly or indirectly, from or by CONTRACTOR's performance or breach of the agreement and/or the provision of goods or services provided that: (a) it is attributable to personal injury, bodily injury, sickness, or death, or to injury to or destruction of property (including the loss of use resulting therefrom), or to or from the negligent acts, errors or omissions or willful misconduct of the CONTRACTOR; and (b) not caused solely by the active negligence or willful misconduct of LFUCG.

(3) In the event LFUCG is alleged to be liable based upon the above, CONTRACTOR shall defend such allegations and shall bear all costs, fees and expenses of such defense, including but not limited to, all reasonable attorneys' fees and expenses, court costs, and expert witness fees and expenses, using attorneys approved in writing by LFUCG, which approval shall not be unreasonably withheld.

(4) These provisions shall in no way be limited by any financial responsibility or insurance requirements, and shall survive the termination of this agreement.

(5) LFUCG is a political subdivision of the Commonwealth of Kentucky. CONTRACTOR acknowledges and agrees that LFUCG is unable to provide indemnity or otherwise save, hold harmless, or defend the CONTRACTOR in any manner.

FINANCIAL RESPONSIBILITY

BIDDER/CONTRACTOR understands and agrees that it shall, prior to final acceptance of its bid and the commencement of any work, demonstrate the ability to assure compliance with the above Indemnity provisions and these other risk management provisions.

INSURANCE REQUIREMENTS

YOUR ATTENTION IS DIRECTED TO THE INSURANCE REQUIREMENTS BELOW, AAND YOU MAY NEED TO CONFER WITH YOUR INSURANCE AGENTS, BROKERS, OR CARRIERS TO DETERMINE IN ADVANCE OF SUBMISSION OF A RESPONSE THE AVAILABILITY OF THE INSURANCE COVERAGES AND ENDORSEMENTS REQUIRED HEREIN. IF YOU FAIL TO COMPLY WITH THE INSURANCE REQUIREMENTS BELOW, YOU MAY BE DISQUALIFIED FROM AWARD OF THE CONTRACT.

Required Insurance Coverage

BIDDER/CONTRACTOR shall procure and maintain for the duration of this contract the following or equivalent insurance policies at no less than the limits shown below and cause its subcontractors to maintain similar insurance with limits acceptable to LFUCG in order to protect LFUCG against claims for injuries to persons or damages to property which may arise from or in connection with the performance of the work hereunder by CONTRACTOR. The cost of such insurance shall be included in any bid:

<u>Coverage</u>	<u>Limits</u>
General Liability aggregate (Insurance Services Office Form CG 00 01)	\$1 million per occurrence, \$2 million or \$2 million combined single limit
Commercial Automobile Liability occurrence (Insurance Services Office Form CA 0001)	combined single, \$1 million per
Worker's Compensation	Statutory
Employer's Liability	\$1,000,000.00

The policies above shall contain the following conditions:

- a. All Certificates of Insurance forms used by the insurance carrier shall be properly filed and approved by the Department of Insurance for the Commonwealth of Kentucky (DOI). LFUCG shall be named as an additional insured in the General Liability Policy and Commercial Automobile Liability Policy using the Kentucky DOI approved forms.
- b. The General Liability Policy shall be primary to any insurance or self-insurance retained by LFUCG.

c. The General Liability Policy shall include a Products and Completed Operations endorsement or Premises and Operations Liability endorsement unless it is deemed not to apply by LFUCG.

d. LFUCG shall be provided at least 30 days advance written notice via certified mail, return receipt requested, in the event any of the required policies are canceled or non-renewed.

e. Said coverage shall be written by insurers acceptable to LFUCG and shall be in a form acceptable to LFUCG. Insurance placed with insurers with a rating classification of no less than Excellent (A or A-) and a financial size category of no less than VIII, as defined by the most current Best's Key Rating Guide shall be deemed automatically acceptable.

Renewals

After insurance has been approved by LFUCG, evidence of renewal of an expiring policy must be submitted to LFUCG, and may be submitted on a manually signed renewal endorsement form. If the policy or carrier has changed, however, new evidence of coverage must be submitted in accordance with these Insurance Requirements.

Deductibles and Self-Insured Programs

IF YOU INTEND TO SUBMIT A SELF-INSURANCE PLAN IT MUST BE FORWARDED TO LEXINGTON-FAYETTE URBAN COUNTY GOVERNMENT, DIVISION OF RISK MANAGEMENT, 200 EAST MAIN STREET, LEXINGTON, KENTUCKY 40507 NO LATER THAN A MINIMUM OF FIVE (5) WORKING DAYS PRIOR TO THE RESPONSE DATE. Self-insurance programs, deductibles, and self-insured retentions in insurance policies are subject to separate approval by Lexington-Fayette Urban County Government's Division of Risk Management, upon review of evidence of BIDDER/CONTRACTOR's financial capacity to respond to claims. Any such programs or retentions must provide LFUCG with at least the same protection from liability and defense of suits as would be afforded by first-dollar insurance coverage. If BIDDER/CONTRACTOR satisfies any portion of the insurance requirements through deductibles, self-insurance programs, or self-insured retentions, BIDDER/CONTRACTOR agrees to provide Lexington-Fayette Urban County Government, Division of Risk Management, the following data prior to the final acceptance of bid and the commencement of any work:

- a. Latest audited financial statement, including auditor's notes.
- b. Any records of any self-insured trust fund plan or policy and related accounting statements.
- c. Actuarial funding reports or retained losses.

- d. Risk Management Manual or a description of the self-insurance and risk management program.
- e. A claim loss run summary for the previous five (5) years.
- f. Self-Insured Associations will be considered.

Safety and Loss Control

CONTRACTOR shall comply with all applicable federal, state, and local safety standards related to the performance of its works or services under this Agreement and take necessary action to protect the life, health and safety and property of all of its personnel on the job site, the public, and LFUCG.

Verification of Coverage

BIDDER/CONTRACTOR agrees to furnish LFUCG with all applicable Certificates of Insurance signed by a person authorized by the insurer to bind coverage on its behalf prior to final award, and if requested, shall provide LFUCG copies of all insurance policies, including all endorsements.

Right to Review, Audit and Inspect

CONTRACTOR understands and agrees that LFUCG may review, audit and inspect any and all of its records and operations to insure compliance with these Insurance Requirements.

DEFAULT

BIDDER/CONTRACTOR understands and agrees that the failure to comply with any of these insurance, safety, or loss control provisions shall constitute default and that LFUCG may elect at its option any single remedy or penalty or any combination of remedies and penalties, as available, including but not limited to purchasing insurance and charging BIDDER/CONTRACTOR for any such insurance premiums purchased, or suspending or terminating the work.

00357187

3. WAGE SCALES

**SPECIAL CONDITIONS
LABOR/EQUAL EMPLOYMENT OPPORTUNITY
INFORMATION PACKAGE**

**FOR
LEXINGTON-FAYETTE URBAN COUNTY GOVERNMENT**

JIM GRAY, MAYOR

LABOR/EEO CONDITIONS INDEX

PROJECT NAME: _____

BID NO. _____

ITEM DESCRIPTION

REQUIRED CONTRACT PROVISIONS FORM FHWA-1273
COMPLIANCE WITH EXECUTIVE ORDER 11246
NOTICE OF REQUIREMENT FOR AFFIRMATIVE ACTION TO ENSURE EQUAL
OPPORTUNITY (EXECUTIVE ORDER 11246)
REPORTING REQUIREMENTS
PATENT RIGHT REQUIREMENTS
COPYRIGHT REQUIREMENTS
ACCESS TO RECORDS REQUIREMENTS AND RECORD RETENTION
REQUIREMENTS
CONTRACT AWARD RESTRICTIONS TO FOREIGN COUNTRIES
KENTUCKY EQUAL EMPLOYMENT OPPORTUNITY ACT
OTHER FEDERAL REQUIREMENTS
PUBLIC LAW 88-352: TITLE VI OF THE CIVIL RIGHTS ACT OF 1964
COMPLIANCE WITH CLEAN AIR AND WATER ACTS
ENERGY EFFICIENCY REQUIREMENTS
LEAD-BASED PAINT CONSIDERATIONS
POTENTIAL DBE CONTRACTOR'S LIST CONTACT
EQUAL EMPLOYMENT OPPORTUNITY AFFIRMATIVE ACTION
DEBARMENT CERTIFICATION (TO BE COMPLETED AND/OR SIGNED)
FEDERAL WAGE SCALE

FORM FHWA-1273

**REQUIRED CONTRACT PROVISIONS FEDERAL - AID CONSTRUCTION
CONTRACTS**

- I. General
- II. Nondiscrimination
- III. Nonsegregated Facilities
- IV. Payment of Predetermined Minimum Wage
- V. Statements and Payrolls
- VI. Record of Materials, Supplies, and Labor
- VII. Subletting or Assigning the Contract
- VIII. Safety: Accident Prevention
- IX. False Statements Concerning Highway Project
- X. Implementation of Clean Air Act and Federal Water Pollution Control Act
- XI. Certification Regarding Debarment, Suspension, Ineligibility, and Voluntary Exclusion
- XII. Certification Regarding Use of Contract Funds for lobbying

ATTACHMENTS

- A. Employment Preference for Appalachian Contracts (included in Appalachian contracts only)

I. GENERAL

- 1. These contract provisions shall apply to all work performed on the contract by the contractor's own organization and with the assistance of workers under the contractor's immediate superintendent and to all work performed on the contract by piecework, station work, or by subcontract.
- 2. Except as otherwise provided for in each section, the contractor shall insert in each subcontract all of the stipulations contained in these Required Contract Provisions, and further require their inclusion in any lower tier subcontract or purchase order that may in turn be made. The Required Contract Provisions shall not be incorporated by reference in any case. The prime contractor shall be responsible for compliance by any subcontractor or lower tier subcontractor with these Required Contract Provisions.
- 3. A breach of any of the stipulations contained in these Required Contract Provisions shall be sufficient grounds for termination of the contract.
- 4. A breach of the following clauses of the Required Contract Provisions may also be grounds for debarment as provided in 29 CFR 5.12:
 - Section I, paragraph 2;
 - Section IV, paragraphs 1, 2, 3, 4, and 7;
 - Section V, paragraphs 1 and 2a through 2g.
- 5. Disputes arising out of the labor standards provisions of Section IV (except paragraph 5) and Section V of these Required Contract Provisions shall not be subject to the general disputes clause of this contract. Such disputes shall be resolved in accordance with the procedures of the U.S. Department of Labor (DOL) as set forth in 29 CFR 5, 6, and 7. Disputes within the meaning of this clause include disputes between the contractor (or

any of its subcontractors) and the contracting agency, the DOL, or the contractor's employees or their representatives.

6. **Selection of Labor:** During the performance of this contract, the contractor shall not:
 - a. discriminate against labor from any other State, possession, or territory of the United States (except for employment preference for Appalachian contracts, when applicable, as specified in Attachment A), or
 - b. employ convict labor for any purpose within the limits of the project unless it is labor performed by convicts who are on parole, supervised release, or probation.

II. NONDISCRIMINATION

(Applicable to all Federal-aid construction contracts and to all related subcontracts of \$10,000 or more.)

1. **Equal Employment Opportunity:** Equal employment opportunity (EEO) requirements not to discriminate and to take affirmative action to assure equal opportunity as set forth under laws, executive orders, rules, regulations (28 CFR 35, 29 CFR 1630 and 41 CFR 60) and orders of the Secretary of Labor as modified by the provisions prescribed herein, and imposed pursuant to 23 U.S.C. 140 shall constitute the EEO and specific affirmative action standards for the contractor's project activities under this contract. The Equal Opportunity Construction Contract Specifications set forth under 41 CFR 60-4.3 and the provisions of the American Disabilities Act of 1990 (42 U.S.C. 12101 *et seq.*) set forth under 28 CFR 35 and 29 CFR 1630 are incorporated by reference in this contract. In the execution of this contract, the contractor agrees to comply with the following minimum specific requirement activities of EEO:
 - a. The contractor will work with the State highway agency (SHA) and the Federal Government in carrying out EEO obligations and in their review of his/her activities under the contract.
 - b. The contractor will accept as his operating policy the following statement:

"It is the policy of this Company to assure that applicants are employed, and that employees are treated during employment, without regard to their race, religion, sex, color, national origin, age or disability. Such action shall include: employment, upgrading, demotion, or transfer; recruitment or recruitment advertising; layoff or termination; rates of pay or other forms of compensation; and selection for training, including apprenticeship, pre-apprenticeship, and/or on-the-job training."
2. **EEO Officer:** The contractor will designate and make known to the SHA contracting officers an EEO Officer who will have the responsibility for and must be capable of effectively administering and promoting an active contractor program of EEO and who must be assigned adequate authority and responsibility to do so.
3. **Dissemination of Policy:** All members of the contractor's staff who are to hire, supervise, promote, and discharge employees, or who recommend such action, or who are substantially involved in such action, will be made fully cognizant of, and will implement, the contractor's EEO policy and contractual will be taken as a minimum:
 - a. Periodic meetings of supervisory and personnel office employees will be conducted before the start of work and then not less often than once every six months, at

- which time the contractor's EEO policy and its implementation will be reviewed and explained. The meetings will be conducted by the EEO Officer.
- b. All new supervisory or personnel office employees will be given a thorough indoctrination by the EEO Officer, covering all major aspects of the contractor's EEO obligations within thirty days following their reporting for duty with the contractor.
 - c. All personnel who are engaged in direct recruitment for the project will be instructed by the EEO Officer in the contractor's procedures for locating and hiring minority group employees.
 - d. Notices and posters setting forth the contractor's EEO policy will be placed in areas readily accessible to employees, applicants for employment and potential employees.
 - e. The contractor's EEO policy and the procedures to implement such policy will be brought to the attention of employees by means of meetings, employee handbooks, or other appropriate means.
4. **Recruitment:** When advertising for employees, the contractor will include in all advertisements for employees the notation: "An Equal Opportunity Employer." All such advertisements will be placed in publications having a large circulation among minority groups in the area from which the project work force would normally be derived.
- a. The contractor will, unless precluded by a valid bargaining agreement, conduct systematic and direct recruitment through public and private employee referral sources likely to yield qualified minority group applicants. To meet this requirement, the contractor will identify sources of potential minority group employees, and establish with such identified sources procedures whereby minority group applicants may be referred to the contractor for employment consideration.
 - b. In the event the contractor has a valid bargaining agreement providing for exclusive hiring hall referrals, he is expected to observe the provisions of that agreement to the extent that the system permits the contractor's compliance with EEO contract provisions. (The DOL has held that where implementation of such agreements have the effect of discriminating against minorities or women, or obligates the contractor to do the same, such implementation violates Executive Order 11246, as amended.)
 - c. The contractor will encourage his present employees to refer minority group applicants for employment. Information and procedures with regard to referring minority group applicants will be discussed with employees.
5. **Personnel Actions:** Wages, working conditions, and employee benefits shall be established and administered, and personnel actions of every type, including hiring, upgrading, promotion, transfer, demotion, layoff, and termination, shall be taken without regard to race, color, religion, sex, national origin, age or disability. The following procedures shall be followed:
- a. The contractor will conduct periodic inspections of project sites to insure that working conditions and employee facilities do not indicate discriminatory treatment of project site personnel.
 - b. The contractor will periodically evaluate the spread of wages paid within each classification to determine any evidence of discriminatory wage practices.

- c. The contractor will periodically review selected personnel actions in depth to determine whether there is evidence of discrimination. Where evidence is found, the contractor will promptly take corrective action. If the review indicates that the discrimination may extend beyond the actions reviewed, such corrective action shall include all affected persons.
 - d. The contractor will promptly investigate all complaints of alleged discrimination made to the contractor in connection with his obligations under this contract, will attempt to resolve such complaints, and will take appropriate corrective action within a reasonable time. If the investigation indicates that the discrimination may affect persons other than the complainant, such corrective action shall include such other persons. Upon completion of each investigation, the contractor will inform every complainant of all of his avenues of appeal.
6. **Training and Promotion:**
- a. The contractor will assist in locating, qualifying, and increasing the skills of minority group and women employees, and applicants for employment.
 - b. Consistent with the contractor's work force requirements and as permissible under Federal and State regulations, the contractor shall make full use of training programs, i.e., apprenticeship, and on-the-job training programs for the geographical area of contract performance. Where feasible, 25 percent of apprentices or trainees in each occupation shall be in their first year of apprenticeship or training. In the event a special provision for training is provided under this contract, this subparagraph will be superseded as indicated in the special provision.
 - c. The contractor will advise employees and applicants for employment of available training programs and entrance requirements for each.
 - d. The contractor will periodically review the training and promotion potential of minority group and women employees and will encourage eligible employees to apply for such training and promotion.
7. **Unions:** If the contractor relies in whole or in part upon unions as a source of employees, the contractor will use his/her best efforts to obtain the cooperation of such unions to increase opportunities for minority groups and women within the unions, and to effect referrals by such unions of minority and female employees. Actions by the contractor either directly or through a contractor's association acting as agent will include the procedures set forth below:
- a. The contractor will use best efforts to develop, in cooperation with the unions, joint training programs aimed toward qualifying more minority group members and women for membership in the unions and increasing the skills of minority group employees and women so that they may qualify for higher paying employment.
 - b. The contractor will use best efforts to incorporate an EEO clause into each union agreement to the end that such union will be contractually bound to refer applicants without regard to their race, color, religion, sex, national origin, age or disability.
 - c. The contractor is to obtain information as to the referral practices and policies of the labor union except that to the extent such information is within the exclusive possession of the labor union and such labor union refuses to furnish such information to the contractor, the contractor shall so certify to the SHA and shall set forth what efforts have been made to obtain such information.

- d. In the event the union is unable to provide the contractor with a reasonable flow of minority and women referrals within the time limit set forth in the collective bargaining agreement, the contractor will, through independent recruitment efforts, fill the employment vacancies without regard to race, color, religion, sex, national origin, age or disability; making full efforts to obtain qualified and/or qualifiable minority group persons and women. (The DOL has held that it shall be no excuse that the union with which the contractor has a collective bargaining agreement providing for exclusive referral failed to refer minority employees.) In the event the union referral practice prevents the contractor from meeting the obligations pursuant to Executive Order 11246, as amended, and these special provisions, such contractor shall immediately notify the SHA.
8. **Selection of Subcontractors, Procurement of Materials and Leasing of Equipment:** The contractor shall not discriminate on the grounds of race, color, religion, sex, national origin, age or disability in the selection and retention of subcontractors, including procurement of materials and leases of equipment.
- a. The contractor shall notify all potential subcontractors and suppliers of his/her EEO obligations under this contract.
 - b. Disadvantaged business enterprises (DBE), as defined in 49 CFR 23, shall have equal opportunity to compete for and perform subcontracts which the contractor enters into pursuant to this contract. The contractor will use his best efforts to solicit bids from and to utilize DBE subcontractors or subcontractors with meaningful minority group and female representation among their employees. Contractors shall obtain lists of DBE construction firms from SHA personnel.
 - c. The contractor will use his best efforts to ensure subcontractor compliance with their EEO obligations.
9. **Records and Reports:** The contractor shall keep such records as necessary to document compliance with the EEO requirements. Such records shall be retained for a period of three years following completion of the contract work and shall be available at reasonable times and places for inspection by authorized representatives of the SHA and the FHWA.
- a. The records kept by the contractor shall document the following:
 - 1. The number of minority and non-minority group members and women employed in each work classification on the project;
 - 2. The progress and efforts being made in cooperation with unions, when applicable, to increase employment opportunities for minorities and women;
 - 3. The progress and efforts being made in locating, hiring, training, qualifying, and upgrading minority and female employees; and
 - 4. The progress and efforts being made in securing the services of DBE subcontractors or subcontractors with meaningful minority and female representation among their employees.
 - b. The contractors will submit an annual report to the SHA each July for the duration of the project, indicating the number of minority, women, and non-minority group employees currently engaged in each work classification required by the contract work. This information is to be reported on Form FHWA-1391. If on-the job training is being required by special provision, the contractor will be required to collect and report training data.

III. NONSEGREGATED FACILITIES

(Applicable to all Federal-aid construction contracts and to all related subcontracts of \$10,000 or more.)

- a. By submission of this bid, the execution of this contract or subcontract, or the consummation of this material supply agreement or purchase order, as appropriate, the bidder, Federal-aid construction contractor, subcontractor, material supplier, or vendor, as appropriate, certifies that the firm does not maintain or provide for its employees any segregated facilities at any of its establishments, and that the firm does not permit its employees to perform their services at any location, under its control, where segregated facilities are maintained. The firm agrees that a breach of this certification is a violation of the EEO provisions of this contract. The firm further certifies that no employee will be denied access to adequate facilities on the basis of sex or disability.
- b. As used in this certification, the term "segregated facilities" means any waiting rooms, work areas, restrooms and washrooms, restaurants and other eating areas, timeclocks, locker rooms, and other storage or dressing areas, parking lots, drinking fountains, recreation or entertainment areas, transportation, and housing facilities provided for employees which are segregated by explicit directive, or are, in fact, segregated on the basis of race, color, religion, national origin, age or disability, because of habit, local custom, or otherwise. The only exception will be for the disabled when the demands for accessibility override (e.g. disabled parking).
- c. The contractor agrees that it has obtained or will obtain identical certification from proposed subcontractors or material suppliers prior to award of subcontracts or consummation of material supply agreements of \$10,000 or more and that it will retain such certifications in its files.

IV. PAYMENT OF PREDETERMINED MINIMUM WAGE

(Applicable to all Federal-aid construction contracts exceeding \$2,000 and to all related subcontracts, except for projects located on roadways classified as local roads or rural minor collectors, which are exempt.)

1. General:

- a. All mechanics and laborers employed or working upon the site of the work will be paid unconditionally and not less often than once a week and without subsequent deduction or rebate on any account [except such payroll deductions as are permitted by regulations (29 CFR 3) issued by the Secretary of Labor under the Copeland Act (40 U.S.C. 276c)] the full amounts of wages and bona fide fringe benefits (or cash equivalents thereof) due at time of payment. The payment shall be computed at wage rates not less than those contained in the wage determination of the Secretary of Labor (hereinafter "the wage determination") which is attached hereto and made a part hereof, regardless of any contractual relationship which may be alleged to exist between the contractor or its subcontractors and such laborers and mechanics. The wage determination (including any additional classifications and wage rates conformed under paragraph 2 of this Section IV and the DOL poster (WH-1321) or Form FHWA-1495) shall be posted at all times by the contractor and its subcontractors at the site of the work in a prominent and accessible place where it

can be easily seen by the workers. For the purpose of this Section, contributions made or costs reasonably anticipated for bona fide fringe benefits under Section 1(b)(2) of the Davis-Bacon Act (40 U.S.C. 276a) on behalf of laborers or mechanics are considered wages paid to such laborers or mechanics, subject to the provisions of Section IV, paragraph 3b, hereof. Also, for the purpose of this Section, regular contributions made or costs incurred for more than a weekly period (but not less often than quarterly) under plans, funds, or programs, which cover the particular weekly period, are deemed to be constructively made or incurred during such weekly period. Such laborers and mechanics shall be paid the appropriate wage rate and fringe benefits on the wage determination for the classification of work actually performed, without regard to skill, except as provided in paragraphs 4 and 5 of this Section IV.

- b. Laborers or mechanics performing work in more than one classification may be compensated at the rate specified for each classification for the time actually worked therein, provided, that the employer's payroll records accurately set forth the time spent in each classification in which work is performed.
- c. All rulings and interpretations of the Davis-Bacon Act and related acts contained in 29 CFR 1, 3, and 5 are herein incorporated by reference in this contract.

2. **Classification:**

- a. The SHA contracting officer shall require that any class of laborers or mechanics employed under the contract, which is not listed in the wage determination, shall be classified in conformance with the wage determination.
- b. The contracting officer shall approve an additional classification, wage rate and fringe benefits only when the following criteria have been met:
 - 1. the work to be performed by the additional classification requested is not performed by a classification in the wage determination;
 - 2. the additional classification is utilized in the area by the construction industry;
 - 3. the proposed wage rate, including any bona fide fringe benefits, bears a reasonable relationship to the wage rates contained in the wage determination; and
 - 4. with respect to helpers, when such a classification prevails in the area in which the work is performed.
- c. If the contractor or subcontractors, as appropriate, the laborers and mechanics (if known) to be employed in the additional classification or their representatives, and the contracting officer agree on the classification and wage rate (including the amount designated for fringe benefits where appropriate), a report of the action taken shall be sent by the contracting officer to the DOL, Administrator of the Wage and Hour Division, Employment Standards Administration, Washington, D.C. 20210. The Wage and Hour Administrator, or an authorized representative, will approve, modify, or disapprove every additional classification action within 30 days of receipt and so advise the contracting officer or will notify the contracting officer within the 30-day period that additional time is necessary.
- d. In the event the contractor or subcontractors, as appropriate, the laborers or mechanics to be employed in the additional classification or their representatives, and the contracting officer do not agree on the proposed classification and wage rate (including the amount designated for fringe benefits, where appropriate), the

contracting officer shall refer the questions, including the views of all interested parties and the recommendation of the contracting officer, to the Wage and Hour Administrator for determination. Said Administrator, or an authorized representative, will issue a determination within 30 days of receipt and so advise the contracting officer or will notify the contracting officer within the 30-day period that additional time is necessary

- e. The wage rate (including fringe benefits where appropriate) determined pursuant to paragraph 2c or 2d of this Section IV shall be paid to all workers performing work in the additional classification from the first day on which work is performed in the classification.

3. **Payment of Fringe Benefits:**

- a. Whenever the minimum wage rate prescribed in the contract for a class of laborers or mechanics includes a fringe benefit which is not expressed as an hourly rate, the contractor or subcontractors, as appropriate, shall either pay the benefit as stated in the wage determination or shall pay another bona fide fringe benefit or an hourly case equivalent thereof.
- b. If the contractor or subcontractor, as appropriate, does not make payments to a trustee or other third person, he/she may consider as a part of the wages of any laborer or mechanic the amount of any costs reasonably anticipated in providing bona fide fringe benefits under a plan or program, provided, that the Secretary of Labor has found, upon the written request of the contractor, that the applicable standards of the Davis-Bacon Act have been met. The Secretary of Labor may require the contractor to set aside in a separate account assets for the meeting of obligations under the plan or program.

4. **Apprentices and Trainees (Programs of U.S. DOL) and Helpers:**

a. Apprentices:

- 1. Apprentices will be permitted to work at less than the predetermined rate for the work they performed when they are employed pursuant to and individually registered in a bona fide apprenticeship program registered with the DOL, Employment and Training Administration, Bureau of Apprenticeship and Training, or with a State apprenticeship agency recognized by the Bureau, or if a person is employed in his/her first 90 days of probationary employment as an apprentice in such an apprenticeship program, who is not individually registered in the program, but who has been certified by the Bureau of Apprenticeship and Training or a State apprenticeship agency (where appropriate) to be eligible for probationary employment as an apprentice.
- 2. The allowable ratio of apprentices to journeyman-level employees on the job site in any craft classification shall not be greater than the ratio permitted to the contractor as to the entire work force under the registered program. Any employee listed on a payroll at an apprentice wage rate, who is not registered or otherwise employed as stated above, shall be paid not less than the applicable wage rate listed in the wage determination for the classification of work actually performed. In addition, any apprentice performing work on the job site in excess of the ratio permitted under the registered program shall be paid not less than the applicable wage rate on

the wage determination for the work actually performed. Where a contractor or subcontractor is performing construction on a project in a locality other than that in which its program is registered, the ratios and wage rates (expressed in percentages of the journeyman-level hourly rate) specified in the contractor's or subcontractor's registered program shall be observed.

3. Every apprentice must be paid at not less than the rate specified in the registered program for the apprentice's level of progress, expressed as a percentage of the journeyman-level hourly rate specified in the applicable wage determination. Apprentices shall be paid fringe benefits in accordance with the provisions of the apprenticeship program. If the apprenticeship program does not specify fringe benefits, apprentices must be paid the full amount of fringe benefits listed on the wage determination for the applicable classification. If the Administrator for the Wage and Hour Division determines that a different practice prevails for the applicable apprentice classification, fringes shall be paid in accordance with that determination.
 4. In the event the Bureau of Apprenticeship and Training, or a State apprenticeship agency recognized by the Bureau, withdraws approval of an apprenticeship program, the contractor or subcontractor will no longer be permitted to utilize apprentices at less than the applicable predetermined rate for the comparable work performed by regular employees until an acceptable program is approved.
- b. Trainees:
1. Except as provided in 29 CFR 5.16, trainees will not be permitted to work at less than the predetermined rate for the work performed unless they are employed pursuant to and individually registered in a program which has received prior approval, evidenced by formal certification by the DOL, Employment and Training Administration.
 2. The ratio of trainees to journeyman-level employees on the job site shall not be greater than permitted under the plan approved by the Employment and Training Administration. Any employee listed on the payroll at a trainee rate who is not registered and participating in a training plan approved by the Employment and Training Administration shall be paid not less than the applicable wage rate on the wage determination for the classification of work actually performed. In addition, any trainee performing work on the job site in excess of the ratio permitted under the registered program shall be paid not less than the applicable wage rate on the wage determination for the work actually performed.
 3. Every trainee must be paid at not less than the rate specified in the approved program for his/her level of progress, expressed as a percentage of the journeyman-level hourly rate specified in the applicable wage determination. Trainees shall be paid fringe benefits in accordance with the provisions of the trainee program. If the trainee program does not mention fringe benefits, trainees shall be paid the full amount of fringe benefits listed on the wage determination unless the Administrator of the Wage and Hour

Division determines that there is an apprenticeship program associated with the corresponding journeyman-level wage rate on the wage determination which provides for less than full fringe benefits for apprentices, in which case such trainees shall receive the same fringe benefits as apprentices.

4. In the event the Employment and Training Administration withdraws approval of a training program, the contractor or subcontractor will no longer be permitted to utilize trainees at less than the applicable predetermined rate for the work performed until an acceptable program is approved.

c. **Helpers:**

Helpers will be permitted to work on a project if the helper classification is specified and defined on the applicable wage determination or is approved pursuant to the conformance procedure set forth in Section IV.2. Any worker listed on a payroll at a helper wage rate, who is not a helper under an approved definition, shall be paid not less than the applicable wage rate on the wage determination for the classification of work actually performed.

5. **Apprentices and Trainees (Programs of the U.S. DOT):**

Apprentices and trainees working under apprenticeship and skill training programs which have been certified by the Secretary of Transportation as promoting EEO in connection with Federal-aid highway construction programs are not subject to the requirements of paragraph 4 of this Section IV. The straight time hourly wage rates for apprentices and trainees under such programs will be established by the particular programs. The ratio of apprentices and trainees to journeymen shall not be greater than permitted by the terms of the particular program.

6. **Withholding:**

The SHA shall upon its own action or upon written request of an authorized representative of the DOL withhold, or cause to be withheld, from the contractor or subcontractor under this contract or any other Federal contract with the same prime contractor, or any other Federally-assisted contract subject to Davis-Bacon prevailing wage requirements which is held by the same prime contractor, as much of the accrued payments or advances as may be considered necessary to pay laborers and mechanics, including apprentices, trainees, and helpers, employed by the contractor or any subcontractor the full amount of wages required by the contract. In the event of failure to pay any laborer or mechanic, including any apprentice, trainee, or helper, employed or working on the site of the work, all or part of the wages required by the contract, the SHA contracting officer may, after written notice to the contractor, take such action as may be necessary to cause the suspension of any further payment, advance, or guarantee of funds until such violations have ceased.

7. **Overtime Requirements:**

No contractor or subcontractor contracting for any part of the contract work which may require or involve the employment of laborers, mechanics, watchmen, or guards (including apprentices, trainees, and helpers described in paragraphs 4 and 5 above) shall require or permit any laborer, mechanic, watchman, or guard in any workweek in which he/she is employed on such work, to work in excess of 40 hours in such workweek unless such laborer, mechanic, watchman, or guard receives compensation at

a rate not less than one-and-one-half times his/her basic rate of pay for all hours worked in excess of 40 hours in such workweek.

8. **Violation:**

Liability for Unpaid Wages; Liquidated Damages: In the event of any violation of the clause set forth in paragraph 7 above, the contractor and any subcontractor responsible thereof shall be liable to the affected employee for his/her unpaid wages. In addition, such contractor and subcontractor shall be liable to the United States (in the case of work done under contract for the District of Columbia or a territory, to such District or to such territory) for liquidated damages. Such liquidated damages shall be computed with respect to each individual laborer, mechanic, watchman, or guard employed in violation of the clause set forth in paragraph 7, in the sum of \$10 for each calendar day on which such employee was required or permitted to work in excess of the standard work week of 40 hours without payment of the overtime wages required by the clause set forth in paragraph 7.

9. **Withholding for Unpaid Wages and Liquidated Damages:**

The SHA shall upon its own action or upon written request of any authorized representative of the DOL withhold, or cause to be withheld, from any monies payable on account of work performed by the contractor or subcontractor under any such contract or any other Federal contract with the same prime contractor, or any other Federally-assisted contract subject to the Contract Work Hours and Safety Standards Act, which is held by the same prime contractor, such sums as may be determined to be necessary to satisfy any liabilities of such contractor or subcontractor for unpaid wages and liquidated damages as provided in the clause set forth in paragraph 8 above.

V. STATEMENTS AND PAYROLLS

(Applicable to all Federal-aid construction contracts exceeding \$2,000 and to all related subcontracts, except for projects located on roadways classified as local roads or rural collectors, which are exempt.)

1. **Compliance with Copeland Regulations (29 CFR 3):**

The contractor shall comply with the Copeland Regulations of the Secretary of Labor which are herein incorporated by reference.

2. **Payrolls and Payroll Records:**

- a. Payrolls and basic records relating thereto shall be maintained by the contractor and each subcontractor during the course of the work and preserved for a period of 3 years from the date of completion of the contract for all laborers, mechanics, apprentices, trainees, watchmen, helpers, and guards working at the site of the work.
- b. The payroll records shall contain the name, social security number, and address of each such employee; his or her correct classification; hourly rates of wages paid (including rates of contributions or costs anticipated for bona fide fringe benefits or cash equivalent thereof the types described in Section 1(b)(2)(B) of the Davis Bacon Act); daily and weekly number of hours worked; deductions made; and actual wages paid. In addition, for Appalachian contracts, the payroll records shall contain a notation indicating whether the employee does, or does not, normally reside in the labor area as defined in Attachment A, paragraph 1. Whenever the

Secretary of Labor, pursuant to Section IV, paragraph 3b, has found that the wages of any laborer or mechanic include the amount of any costs reasonably anticipated in providing benefits under a plan or program described in Section 1(b)(2)(B) of the Davis Bacon Act, the contractor and each subcontractor shall maintain records which show that the commitment to provide such benefits is enforceable, that the plan or program is financially responsible, that the plan or program has been communicated in writing to the laborers or mechanics affected, and show the cost anticipated or the actual cost incurred in providing benefits. Contractors or subcontractors employing apprentices or trainees under approved programs shall maintain written evidence of the registration of apprentices and trainees, and ratios and wage rates prescribed in the applicable programs.

- c. Each contractor and subcontractor shall furnish, each week in which any contract work is performed, to the SHA resident engineer a payroll of wages paid each of its employees (including apprentices, trainees, and helpers, described in Section IV, paragraphs 4 and 5, and watchmen and guards engaged on work during the preceding weekly payroll period). The payroll submitted shall set out accurately and completely all of the information required to be maintained under paragraph 2b of this Section V. This information may be submitted in any form desired. Optional Form WH-347 is available for this purpose and may be purchased from the Superintendent of Documents (Federal stock number 029-005-0014-1), U.S. Government Printing Office, Washington, D.C. 20402. The prime contractor is responsible for the submission of copies of payrolls by all subcontractors.
- d. Each payroll submitted shall be accompanied by a "Statement of Compliance," signed by the contractor or subcontractor or his/her agent who pays or supervises the payment of the persons employed under the contract and shall certify the following:
 - 1. that the payroll for the payroll period contains the information required to be maintained under paragraph 2b of this Section V and that such information is correct and complete;
 - 2. that such laborer or mechanic (including each helper, apprentice, and trainee) employed on the contract during the payroll period has been paid the full weekly wages earned, without rebate, either directly or indirectly, and that no deductions have been made either directly or indirectly from the full wages earned, other than permissible deductions as set forth in the Regulations, 29 CFR 3;
 - 3. that each laborer or mechanic has been paid not less than the applicable wage rate and fringe benefits or cash equivalent for the classification of work performed, as specified in the applicable wage determination incorporated into the contract.
- e. The weekly submission of a properly executed certification set forth on the reverse side of Optional Form WH-347 shall satisfy the requirement for submission of the "Statement of Compliance" required by paragraph 2d of this Section V.
- f. The falsification of any of the above certifications may subject the contractor to civil or criminal prosecution under 18 U.S.C. 1001 and 31 U.S.C. 231.
- g. The contractor or subcontractor shall make the records required under paragraph 2b of this Section V available for inspection, copying, or transcription by authorized

representatives of the SHA, the FHWA, or the DOL, and shall permit such representatives to interview employees during working hours on the job. If the contractor or subcontractor fails to submit the required records or to make them available, the SHA, the FHWA, the DOL, or all may, after written notice to the contractor, sponsor, applicant, or owner, take such actions as may be necessary to cause the suspension of any further payment, advance, or guarantee of funds. Furthermore, failure to submit the required records upon request or to make such records available may be grounds for debarment action pursuant to 29 CFR 5.12.

**VI. RECORD OF MATERIALS, SUPPLIES AND LABOR THIS SECTION DELETED
JUNE 4, 2007.**

VII. SUBLETTING OR ASSIGNING THE CONTRACT

1. The contractor shall perform with its own organization contract work amounting to not less than 30 percent (or a greater percentage if specified elsewhere in the contract) of the total original contract price, excluding any specialty items designated by the State. Specialty items may be performed by subcontract and the amount of any such specialty items performed may be deducted from the total original contract price before computing the amount of work required to be performed by the contractor's own organization (23 CFR 635).
 - a. "Its own organization" shall be construed to include only workers employed and paid directly by the prime contractor and equipment owned or rented by the prime contractor, with or without operators. Such term does not include employees or equipment of a subcontractor, assignee, or agent of the prime contractor.
 - b. "Specialty Items" shall be construed to be limited to work that requires highly specialized knowledge, abilities, or equipment not ordinarily available in the type of contracting organizations qualified and expected to bid on the contract as a whole and in general are to be limited to minor components of the overall contract.
2. The contract amount upon which the requirements set forth in paragraph 1 of Section VII is computed includes the cost of material and manufactured products which are to be purchased or produced by the contractor under the contract provisions.
3. The contractor shall furnish (a) a competent superintendent or supervisor who is employed by the firm, has full authority to direct performance of the work in accordance with the contract requirements, and is in charge of all construction operations (regardless of who performs the work) and (b) such other of its own organizational resources (supervision, management, and engineering services) as the SHA contracting officer determines is necessary to assure the performance of the contract.
4. No portion of the contract shall be sublet, assigned or otherwise disposed of except with the written consent of the SHA contracting officer, or authorized representative, and such consent when given shall not be construed to relieve the contractor of any responsibility for the fulfillment of the contract. Written consent will be given only after the SHA has assured that each subcontract is evidenced in writing and that it contains all pertinent provisions and requirements of the prime contract.

VIII. SAFETY: ACCIDENT PREVENTION

1. In the performance of this contract the contractor shall comply with all applicable Federal, State, and local laws governing safety, health, and sanitation (23 CFR 635). The contractor shall provide all safeguards, safety devices and protective equipment and take any other needed actions as it determines, or as the SHA contracting officer may determine, to be reasonably necessary to protect the life and health of employees on the job and the safety of the public and to protect property in connection with the performance of the work covered by the contract.
2. It is a condition of this contract, and shall be made a condition of each subcontract, which the contractor enters into pursuant to this contract, that the contractor and any subcontractor shall not permit any employee, in performance of the contract, to work in surroundings or under conditions which are unsanitary, hazardous or dangerous to his/her health or safety, as determined under construction safety and health standards (29 CFR 1926) promulgated by the Secretary of Labor, in accordance with Section 107 of the Contract Work Hours and Safety Standards Act (40 U.S.C. 333).
3. Pursuant to 29 CFR 1926.3, it is a condition of this contract that the Secretary of Labor or authorized representative thereof, shall have right of entry to any site of contract performance to inspect or investigate the matter of compliance with the construction safety and health standards and to carry out the duties of the Secretary under Section 107 of the Contract Work Hours and Safety Standards Act (40 U.S.C. 333).

IX. FALSE STATEMENTS CONCERNING HIGHWAY PROJECTS

In order to assure high quality and durable construction in conformity with approved plans and specifications and a high degree of reliability on statements and representations made by engineers, contractors, suppliers, and workers on Federal-aid highway projects, it is essential that all persons concerned with the project perform their functions as carefully, thoroughly, and honestly as possible. Willful falsification, distortion, or misrepresentation with respect to any facts related to the project is a violation of Federal law. To prevent any misunderstanding regarding the seriousness of these and similar acts, the following notice shall be posted on each Federal-aid highway project (23 CFR 635) in one or more places where it is readily available to all persons concerned with the project:

NOTICE TO ALL PERSONNEL ENGAGED ON FEDERAL-AID HIGHWAY PROJECTS

18 U.S.C. 1020 reads as follows:

"Whoever, being an officer, agent, or employee of the United States, or of any State or Territory, or whoever, whether a person, association, firm, or corporation, knowingly makes any false statement, false representation, or false report as to the character, quality, quantity, or cost of the material used or to be used, or the quantity or quality of the work performed or to be performed, or the cost thereof in connection with the submission of

plans, maps, specifications, contracts, or costs of construction on any highway or related project submitted for approval to the Secretary of Transportation; or

Whoever knowingly makes any false statement, false representation, false report or false claim with respect to the character, quality, quantity, or cost of any work performed or to be performed, or materials furnished or to be furnished, in connection with the construction of any highway or related project approved by the Secretary of Transportation; or

Whoever knowingly makes any false statement or false representation as to material fact in any statement, certificate, or report submitted pursuant to provisions of the Federal-aid Roads Act approved July 1, 1916, (39 Stat. 355), as amended and supplemented;

Shall be fined not more than \$10,000 or imprisoned not more than 5 years or both."

X. IMPLEMENTATION OF CLEAN AIR ACT AND FEDERAL WATER POLLUTION CONTROL ACT

(Applicable to all Federal-aid construction contracts and to all related subcontracts of \$100,000 or more.)

By submission of this bid or the execution of this contract, or subcontract, as appropriate, the bidder, Federal-aid construction contractor, or subcontractor, as appropriate, will be deemed to have stipulated as follows:

1. That any facility that is or will be utilized in the performance of this contract, unless such contract is exempt under the Clean Air Act, as amended (42 U.S.C. 1857 et seq., as amended by Pub.L. 91-604), and under the Federal Water Pollution Control Act, as amended (33 U.S.C. 1251 et seq., as amended by Pub.L. 92-500), Executive Order 11738, and regulations in implementation thereof (40 CFR 15) is not listed, on the date of contract award, on the U.S. Environmental Protection Agency (EPA) List of Violating Facilities pursuant to 40 CFR 15.20.
2. That the firm agrees to comply and remain in compliance with all the requirements of Section 114 of the Clean Air Act and Section 308 of the Federal Water Pollution Control Act and all regulations and guidelines listed thereunder.
3. That the firm shall promptly notify the SHA of the receipt of any communication from the Director, Office of Federal Activities, EPA, indicating that a facility that is or will be utilized for the contract is under consideration to be listed on the EPA List of Violating Facilities.
4. That the firm agrees to include or cause to be included the requirements of paragraph 1 through 4 of this Section X in every nonexempt subcontract, and further agrees to take such action as the government may direct as a means of enforcing such requirements.

XI. CERTIFICATION REGARDING DEBARMENT, SUSPENSION, INELIGIBILITY AND VOLUNTARY EXCLUSION

1. **Instructions for Certification - Primary Covered Transactions:**
(Applicable to all Federal-aid contracts - 49 CFR 29)

- a. By signing and submitting this proposal, the prospective primary participant is providing the certification set out below.
- b. The inability of a person to provide the certification set out below will not necessarily result in denial of participation in this covered transaction. The prospective participant shall submit an explanation of why it cannot provide the certification set out below. The certification or explanation will be considered in connection with the department or agency's determination whether to enter into this transaction. However, failure of the prospective primary participant to furnish a certification or an explanation shall disqualify such a person from participation in this transaction.
- c. The certification in this clause is a material representation of fact upon which reliance was placed when the department or agency determined to enter into this transaction. If it is later determined that the prospective primary participant knowingly rendered an erroneous certification, in addition to other remedies available to the Federal Government, the department or agency may terminate this transaction for cause of default.
- d. The prospective primary participant shall provide immediate written notice to the department or agency to whom this proposal is submitted if any time the prospective primary participant learns that its certification was erroneous when submitted or has become erroneous by reason of changed circumstances.
- e. The terms "covered transaction," "debarred," "suspended," "ineligible," "lower tier covered transaction," "participant," "person," "primary covered transaction," "principal," "proposal," and "voluntarily excluded," as used in this clause, have the meanings set out in the Definitions and Coverage sections of rules implementing Executive Order 12549. You may contact the department or agency to which this proposal is submitted for assistance in obtaining a copy of those regulations.
- f. The prospective primary participant agrees by submitting this proposal that, should the proposed covered transaction be entered into, it shall not knowingly enter into any lower tier covered transaction with a person who is debarred, suspended, declared ineligible, or voluntarily excluded from participation in this covered transaction, unless authorized by the department or agency entering into this transaction.
- g. The prospective primary participant further agrees by submitting this proposal that it will include the clause titled "Certification Regarding Debarment, Suspension, Ineligibility and Voluntary Exclusion-Lower Tier Covered Transaction," provided by the department or agency entering into this covered transaction, without modification, in all lower tier covered transactions and in all solicitations for lower tier covered transactions.
- h. A participant in a covered transaction may rely upon a certification of a prospective participant in a lower tier covered transaction that is not debarred, suspended, ineligible, or voluntarily excluded from the covered transaction, unless it knows that the certification is erroneous. A participant may decide the method and frequency by which it determines the eligibility of its principals. Each participant may, but is not required to, check the nonprocurement portion of the "Lists of Parties Excluded From Federal Procurement or Nonprocurement Programs" (Nonprocurement List) which is compiled by the General Services Administration.

- i. Nothing contained in the foregoing shall be construed to require establishment of a system of records in order to render in good faith the certification required by this clause. The knowledge and information of participant is not required to exceed that which is normally possessed by a prudent person in the ordinary course of business dealings.
- j. Except for transactions authorized under paragraph f of these instructions, if a participant in a covered transaction knowingly enters into a lower tier covered transaction with a person who is suspended, debarred, ineligible, or voluntarily excluded from participation in this transaction, in addition to other remedies available to the Federal Government, the department or agency may terminate this transaction for cause or default.

* * * * *

Certification Regarding Debarment, Suspension, Ineligibility and Voluntary Exclusion--Primary Covered Transactions

1. The prospective primary participant certifies to the best of its knowledge and belief, that it and its principals:
 - a. Are not presently debarred, suspended, proposed for debarment, declared ineligible, or voluntarily excluded from covered transactions by any Federal department or agency;
 - b. Have not within a 3-year period preceding this proposal been convicted of or had a civil judgment rendered against them for commission of fraud or a criminal offense in connection with obtaining, attempting to obtain, or performing a public (Federal, State or local) transaction or contract under a public transaction; violation of Federal or State antitrust statutes or commission of embezzlement, theft, forgery, bribery, falsification or destruction of records, making false statements, or receiving stolen property;
 - c. Are not presently indicted for or otherwise criminally or civilly charged by a governmental entity (Federal, State or local) with commission of any of the offenses enumerated in paragraph 1b of this certification; and
 - d. Have not within a 3-year period preceding this application/proposal had one or more public transactions (Federal, State or local) terminated for cause or default.
2. Where the prospective primary participant is unable to certify to any of the statements in this certification, such prospective participant shall attach an explanation to this proposal.

* * * * *

2. Instructions for Certification - Lower Tier Covered Transactions:

(Applicable to all subcontracts, purchase orders and other lower tier transactions of \$25,000 or more - 49 CFR 29)

- a. By signing and submitting this proposal, the prospective lower tier is providing the certification set out below.

- b. The certification in this clause is a material representation of fact upon which reliance was placed when this transaction was entered into. If it is later determined that the prospective lower tier participant knowingly rendered an erroneous certification, in addition to other remedies available to the Federal Government, the department, or agency with which this transaction originated may pursue available remedies, including suspension and/or debarment.
- c. The prospective lower tier participant shall provide immediate written notice to the person to which this proposal is submitted if at any time the prospective lower tier participant learns that its certification was erroneous by reason of changed circumstances.
- d. The terms "covered transaction," "debarred," "suspended," "ineligible," "primary covered transaction," "participant," "person," "principal," "proposal," and "voluntarily excluded," as used in this clause, have the meanings set out in the Definitions and Coverage sections of rules implementing Executive Order 12549. You may contact the person to which this proposal is submitted for assistance in obtaining a copy of those regulations.
- e. The prospective lower tier participant agrees by submitting this proposal that, should the proposed covered transaction be entered into, it shall not knowingly enter into any lower tier covered transaction with a person who is debarred, suspended, declared ineligible, or voluntarily excluded from participation in this covered transaction, unless authorized by the department or agency with which this transaction originated.
- f. The prospective lower tier participant further agrees by submitting this proposal that it will include this clause titled "Certification Regarding Debarment, Suspension, Ineligibility and Voluntary Exclusion-Lower Tier Covered Transaction," without modification, in all lower tier covered transactions and in all solicitations for lower tier covered transactions.
- g. A participant in a covered transaction may rely upon a certification of a prospective participant in a lower tier covered transaction that is not debarred, suspended, ineligible, or voluntarily excluded from the covered transaction, unless it knows that the certification is erroneous. A participant may decide the method and frequency by which it determines the eligibility of its principals. Each participant may, but is not required to, check the Nonprocurement List.
- h. Nothing contained in the foregoing shall be construed to require establishment of a system of records in order to render in good faith the certification required by this clause. The knowledge and information of participant is not required to exceed that which is normally possessed by a prudent person in the ordinary course of business dealings.
- i. Except for transactions authorized under paragraph e of these instructions, if a participant in a covered transaction knowingly enters into a lower tier covered transaction with a person who is suspended, debarred, ineligible, or voluntarily excluded from participation in this transaction, in addition to other remedies available to the Federal Government, the department or agency with which this transaction originated may pursue available remedies, including suspension and/or debarment.

* * * * *

Certification Regarding Debarment, Suspension, Ineligibility and Voluntary Exclusion--Lower Tier Covered Transactions:

1. The prospective lower tier participant certifies, by submission of this proposal, that neither it nor its principals is presently debarred, suspended, proposed for debarment, declared ineligible, or voluntarily excluded from participation in this transaction by any Federal department or agency.
2. Where the prospective lower tier participant is unable to certify to any of the statements in this certification, such prospective participant shall attach an explanation to this proposal.

* * * * *

XII. CERTIFICATION REGARDING USE OF CONTRACT FUNDS FOR LOBBYING

(Applicable to all Federal-aid construction contracts and to all related subcontracts which exceed \$100,000 - 49 CFR 20)

1. The prospective participant certifies, by signing and submitting this bid or proposal, to the best of his or her knowledge and belief, that:
 - a. No Federal appropriated funds have been paid or will be paid, by or on behalf of the undersigned, to any person for influencing or attempting to influence an officer or employee of any Federal agency, a Member of Congress, an officer or employee of Congress, or an employee of a Member of Congress in connection with the awarding of any Federal contract, the making of any Federal grant, the making of any Federal loan, the entering into of any cooperative agreement, and the extension, continuation, renewal, amendment, or modification of any Federal contract, grant, loan, or cooperative agreement.
 - b. If any funds other than Federal appropriated funds have been paid or will be paid to any person for influencing or attempting to influence an officer or employee of any Federal agency, a Member of Congress, an officer or employee of Congress, or an employee of a Member of Congress in connection with this Federal contract, grant, loan, or cooperative agreement, the undersigned shall complete and submit Standard Form-LLL, "Disclosure Form to Report Lobbying," in accordance with its instructions.
2. This certification is a material representation of fact upon which reliance was placed when this transaction was made or entered into. Submission of this certification is a prerequisite for making or entering into this transaction imposed by 31 U.S.C. 1352. Any person who fails to file the required certification shall be subject to a civil penalty of not less than \$10,000 and not more than \$100,000 for each such failure.
3. The prospective participant also agrees by submitting his or her bid or proposal that he or she shall require that the language of this certification be included in all lower tier subcontracts, which exceed \$100,000 and that all such recipients shall certify and disclose accordingly.

COMPLIANCE WITH EXECUTIVE ORDER 11246

During the performance of this contract, the contractor agrees as follows:

1. The contractor will not discriminate against any employee or applicant for employment because of race, creed, color, or national origin. The contractor will take affirmative action to ensure that applicants are employed, and that employees are treated, during employment without regard to their race, creed, color, or national origin. Such action shall include, but not be limited to the following: Employment, upgrading, demotion or transfer, recruitment or recruitment advertising; layoff or termination; rates of pay or other forms of compensation; and selection for training, including apprenticeship. The contractor agrees to post in conspicuous place, available to employees and applicants for employment, notices to be provided setting forth the provisions of this non-discrimination clause.
2. The contractor will, in all solicitations or advertisements for employees placed on behalf of the contractor, state that all qualified applicants will receive consideration for employment without regard to race, creed, color, or national origin.
3. The contractor will send to each labor union or representative of workers with which he has a collective bargaining agreement or other contract of understanding, a notice to be provided advising the said labor union or worker's representative of the contractor's commitments under this section, and shall post copies of the notice in conspicuous place available to employees and applicants for employment. The contractor will take such action with respect to any subcontract or purchase order as the administering agency may direct as a means of enforcing such provisions, including sanctions for noncompliance.

In case the work to be performed is paid for in whole or in part with funds obtained from the Federal Government or borrowed on the credit of the Federal Government pursuant to a grant, contract, loan, insurance or guarantee, or undertaken pursuant to any Federal Program involving such grant, contract, loan, insurance or guarantee, during the performance of this contract, the Contractor, in addition, agrees to comply with:

4. All provisions of the latest current Executive Order and executive amendments, of the rules, regulations and relevant orders of the President's Committee on Equal Employment Opportunity created thereby.
5. The contractor will furnish all information and reports required by the Executive, and by the rules, regulations and orders of the said committee, or pursuant thereto, and will permit access to his books, records and accounts by the administering agency and the Committee for purposes of investigation to ascertain compliance with such rules, regulations and orders.
6. In the event of the contractor's noncompliance with the non-discrimination clauses of this contract or with any of the said rules, regulations or orders, this contract may be canceled, terminated or suspended in whole or in part and the contractor may be declared ineligible for further Government contracts or Federally assigned construction contracts in accordance with procedures authorized in the Executive Order, and such other sanctions may be imposed and remedies invoked

as provided in the said Executive Order or by rule, regulation or order of the President's Committee on Equal Employment Opportunity or as otherwise provided by law.

7. The contractor will include the provisions of Paragraphs (1) through (7) in every sub-contract or purchase order unless exempted by rules, regulations or orders of the President's Committee on Equal Employment Opportunity, so that provisions will be binding upon each sub-contractor or vendor. The contractor will take such action with respect to any sub-contractor purchase order as the administering agency may direct as a means of enforcing such provisions, including sanctions for noncompliance; provided, however, that in the event a contractor becomes involved in, or is threatened with, litigation with a sub-contractor or vendor as a result of such direction by the agency, the contractor may request the United States to enter into such litigation to protect the interests of the United States.

NOTICE OF REQUIREMENT FOR AFFIRMATIVE ACTION TO ENSURE EQUAL
EMPLOYMENT OPPORTUNITY
(EXECUTIVE ORDER 11246)

1. The Offeror's or Bidder's attention is called to the "Equal Opportunity Clause" and the Standard Federal Equal Employment Opportunity Construction Specifications" set forth herein.
2. The goals and timetables for minority and female participation, expressed in percentage terms for the Contractor's aggregate workforce in each trade on all construction work in the covered area, are as follows:

<u>Timetables</u>	Goals for minority	Goals for female
Current	participation for each trade 10.8%	participation in each trade 6.9%

These goals are applicable to all the Contractor's construction work performed in the covered area, whether or not it is federally assisted.

The Contractor's compliance with the Executive Order and the regulations in 41 CFR Part 60-4 shall be based on its implementation of the Equal Opportunity Clause, specific affirmative action obligations required by the specifications set forth in 41 CFR 60.4.3(a), and its efforts to meet the goals established for the geographical area where the contract resulting from this solicitation is to be performed. The hours of minority and female employment and training must be substantially uniform throughout the length of the contract, and in each trade, and the contractor shall make a good faith effort to employ minorities and women evenly on each of its projects. The transfer of minority or female employees or trainees from Contractor to Contractor or from project to project to project for the sole purpose of meeting the Contractor's goals shall be a violation of the contract, the Executive Order and the regulations in 41 CFR Part 60-4. Compliance with the goals will be measured against the total work hours performed.

3. The Contractor shall provide written notification to the Director of the Office of Federal Contract Compliance Programs within 10 working days of award of any construction subcontract in excess of \$10,000 at any tier for construction work under the contract resulting from this solicitation. The notification shall list the name, address and telephone number of the subcontractor; employer identification number; estimated dollar amount of the subcontract; estimated starting and completion dates of the subcontract; and the geographical area in which the contract is to be performed.
4. As used in this Notice, and in the contract resulting from this solicitation, the "covered area" is the State of Kentucky, County of Fayette, City of Lexington.

REPORTING REQUIREMENTS

Notice of awarding agency requirements and regulations pertaining to reporting.

A. Preconstruction Conference

Before Contractor starts the work at the proposed site, a conference attended by the Contractor, Engineer/Architect, Contract Compliance Officer, and other appropriate parties will be held to discuss the following issues: (1) The scheduling of the work to be completed; (2) The procedures for handling shop drawings and other submittals; (3) The processing of applications for payment; (4) The establishment of an understanding among the involved parties in regard to the proposed project; and (5) The establishment of procedures for effectively implementing the 10% minimum DBE goals.

B. Documents Required of Contractor

Documentation showing the percentage of the DBE employment levels on each project of the Bidder's current work force, and DBE participation levels for Subcontractors.

C. Optional Owner Requirements

The Owner, at its discretion, may require the Contractor to provide: (1) financial security in amounts and kind deemed necessary by the Owner or require other financial security to meet the financial responsibility requirements of the Contractor to indemnify the Owner; (2) Additional information and/or DBE work data, as well as DBE participation data.

PATENT RIGHT REQUIREMENTS

Notice of awarding agency requirements and regulations pertaining to patent rights with respect to any discovery or invention which arises or is developed in the course of or under such contract.

§ 401.14 STANDARD PATENT RIGHTS CLAUSES

The following is the standard patent rights clause to be used as specified in -
§401.3(a).

Patent Rights (Small Business Firms and Nonprofit Organizations)

A. Definitions

1. "Invention" means any invention or discovery which is or may be patentable or otherwise protectable under Title 35 of the United States Code, or any novel variety of plant which is or may be protected under the Plant Variety Protection Act (7 U.S.C. 2321 et seq.).
2. "Subject invention" means any invention of the **contractor** conceived or first actually reduced to practice in the performance of work under this **contract**, provided that in the case of a variety of plant, the date of determination (as defined in section 41(d) of the Plant Variety Protection Act, 7 U.S.C. 2401(d) must also occur during the period of **contract** performance.
3. "Practical Application" means to manufacture in the case of a composition or product, to practice in the case of a process or method, or to operate in the case of a machine or system; and, in each case, under such conditions as to establish that the invention is being utilized and that its benefits are, to the extent permitted by law or government regulations, available to the public on reasonable terms.
4. "Made" when used in relation to any invention means the conception or first actual reduction to practice such invention.
5. "Small Business Firm" means a small business concern as defined at section 2 of Pub. L. 85-536 (15 U.S.C. 632) and implementing regulations of the Administrator of the Small Business Administration. For the purpose of this clause, the size standards for small business concerns involved in government procurement and subcontracting at 13 CFR 121.3-8 and 13 CFR 121.3-12, respectively, will be used.
6. "Nonprofit Organization" means a university or other institution of higher education or an organization of the type described in section 501(c)(3) of the Internal Revenue Code of 1954 (26 U.S.C. 501(c) and exempt from taxation under section 501(a) of the Internal Revenue Code (25 U.S.C 501 (a)) or any nonprofit scientific or educational organization qualified under a state nonprofit organization statute.

B. Allocation of Principal Rights

1. The **Contractor** may retain the entire right, title, and interest throughout the world to each subject invention, subject to the provisions of this clause and 35 U.S.C. 203. With respect to any subject invention in which the **Contractor** retains title, the Federal Government shall have a nonexclusive, nontransferable, irrevocable, paid-up license to practice or have practiced for or on behalf of the United States the subject invention throughout the world.

C. Invention Disclosure, Election of Title and Filing of Patent Application by **Contractor**.

1. The **Contractor** will disclose each subject invention to the Federal Agency within two months after the inventor discloses it in writing to **contractor** personnel responsible for patent matters. The disclosure to the agency shall be in the form of a written report and shall identify the contract under which the invention was made and the inventor(s). It shall be sufficiently complete in technical detail to convey a clear understanding to the extent known at the time of the disclosure, of the nature, purpose, operation, and the physical, chemical, biological or electrical characteristics of the invention. The disclosure shall also identify any publication, on sale or public use of the invention and whether a manuscript describing the invention has been submitted for publication and, if so, whether it has been accepted for publication at the time of disclosure. In addition, after disclosure to the agency the Contractor will promptly notify the agency of the acceptance of any manuscript describing the invention for publication or of any on sale or public use planned by the contractor.
2. The Contractor will elect in writing whether or not to retain title to any such invention by notifying the Federal agency within two years of disclosure to the Federal agency. However, in any case where publication, on sale or public use has initiated the one year statutory period wherein valid patent protection can still be obtained in the United States, the period for election of title may be shortened by the agency to a date that is no more than 60 days prior to the end of the statutory period.
3. The Contractor will file its initial patent application on a subject invention to which it elects to retain title within one year after election of title or, if earlier, prior to the end of any statutory period wherein valid patent protection can be obtained in the United States after a publication, on sale, or public use. The Contractor will file patent applications in additional countries or international patent offices within either ten months of the corresponding initial patent application or six months from the date permission is granted by the Commissioner of Patents and Trademarks to file foreign patent applications where such filing has been prohibited by a Secrecy Order.
4. Requests for extension of the time for disclosure, election, and filing under subparagraphs (1), (2), and (3) may, at the discretion of the agency, be granted.

D. Conditions When the Government May Obtain Title

The Contractor will convey to the Federal agency, upon written request, title to any subject invention--

1. If the contractor fails to disclose or elect title to the subject invention within the times specified in (C), above, or elects not to retain title; provided that the agency may only request title within 60 days after learning of the failure of the contractor to disclose or elect within the specified times.
2. In those countries in which the contractor fails to file patent applications within the times specified in (C) above; provided, however, that if the contractor has filed a patent application in a country after the times specified in (C) above, but prior to its receipt of the written request of the Federal agency, the contractor shall continue to retain title in that country.
3. In any country in which the contractor decides not to continue the prosecution of any application for, to pay the maintenance fees on, or defend in reexamination or opposition proceeding on, a patent on a subject invention.

E. Minimum Rights to Contractor and Protection of the Contractor Right to File

1. The contractor will retain a nonexclusive royalty-free license throughout the world in each subject invention to which the Government obtains title, except if the contractor fails to disclose the invention within the times specified in (C), above. The contractor's license extends to its domestic subsidiary and affiliates, if any, within the corporate structure of which the contractor is a party and includes the right to grant sublicenses of the same scope to the extent the contractor was legally obligated to do so at the time the contract was awarded. The license is transferable only with the approval of the Federal agency except when transferred to the successor of that party of the contractor's business to which the invention pertains.
2. The contractor's domestic license may be revoked or modified by the funding Federal agency to the extent necessary to achieve expeditious practical application of the subject invention pursuant to an application for an exclusive license submitted in accordance with applicable provisions at 37 CFR Part 404 and agency licensing regulations (if any). This license will not be revoked in that field of use or the geographical areas in which the contractor has achieved practical application and continues to make the benefits of the invention reasonably accessible to the public. The license in any foreign country may be revoked or modified at the discretion of the funding Federal agency to the extent the contractor, its licensees, or the domestic subsidiaries or affiliates have failed to achieve practical application in that foreign country.
3. Before revocation or modification of the license, the funding Federal agency will furnish the contractor a written notice of its intention to revoke or modify the

license, and the contractor will be allowed thirty days (or such other time as may be authorized by the funding Federal agency for good cause shown by the contractor) after the notice to show cause why the license should not be revoked or modified. The contractor has the right to appeal, in accordance with applicable regulations in 37 CFR Part 404 and agency regulations (if any) concerning the licensing of Government-owned inventions, any decision concerning the revocation or modification of the license.

F. Contractor Action to Protect the Government's Interest

1. The contractor agrees to execute or to have executed and promptly deliver to the Federal agency all instruments necessary to (i) establish or confirm the rights the Government has throughout the world in those subject inventions to which the contractor elects to retain title, and (ii) convey title to the Federal agency when requested under paragraph (D) above and to enable the government to obtain patent protection throughout the world in that subject invention.
2. The contractor agrees to require, by written agreement, its employees, other than clerical and non-technical employees, to disclose promptly in writing to personnel identified as responsible for the administration of patent matters and in a format suggested by the contractor each subject invention made under contract in order that the contractor can comply with the disclosure provisions of paragraph (C), above, and to execute all papers necessary to file patent applications on subject inventions and to establish the government's rights in the subject inventions. This disclosure format should require, as a minimum, the information required by (C)(1), above. The contractor shall instruct such employees through employee agreements or other suitable educational programs on the importance of reporting inventions in sufficient time to permit the filing of patent applications prior to U.S. or foreign statutory bars.
3. The contractor will notify the Federal agency of any decisions not to continue the prosecution of a patent application, pay maintenance fees, or defend in a reexamination or opposition proceeding on a patent, in any country, not less than thirty days before the expiration of the response period required by the relevant patent office.
4. The contractor agrees to include, within the specification of any United States patent applications and any patent issuing thereon covering a subject invention, the following statement, "This invention was made with government support under (identify the contract) awarded by (identify the Federal agency). The government has certain rights in the invention."

G. Subcontracts

1. The contractor will include this clause, suitably modified to identify the parties, in all subcontracts, regardless of tier for experimental, developmental or research work to be performed by a small business firm or domestic nonprofit organization. The

subcontractor will retain all rights provided for the contractor in this clause, and the contractor will not, as part of the consideration for awarding the subcontractor, obtain rights in the subcontractor's subject inventions.

2. The contractor will include in all other subcontracts, regardless of tier, for experimental developmental or research work the patent rights clause required by (cite section of agency implementing regulations or FAR).
3. In the case of subcontracts, at any tier, when the prime award with the Federal agency was a contract (but not a grant or cooperative agreement), the agency, subcontractor, and the contractor agree that the mutual obligations of the parties created by this clause constitute a contract between the subcontractor and the Federal agency with respect to the matters covered by the clause; provided, however, that nothing in this paragraph is intended to confer any jurisdiction under the Contract Disputes Act in connection with proceedings under paragraph (J) of this clause.

H. Reporting Utilization of Subject Inventions

1. The Contractor agrees to submit on request periodic reports no more frequently than annually on the utilization of a subject invention or on efforts at obtaining such utilization that are being made by the contractor or its licensees or assignees. Such reports shall include information regarding the status of development, date of first commercial sale or use, gross royalties received by the contractor, and such other data and information as the agency may reasonably specify. The contractor also agrees to provide additional reports as may be requested by the agency in connection with any march-in proceeding undertaken by the agency in accordance with paragraph (J) of this clause. As required by 35 U.S.C. 202 (C)(5), the agency agrees it will not disclose such information to persons outside the government without permission of the contractor.

I. Preference for United States Industry

Notwithstanding any other provision of this clause, the contractor agrees that neither it nor any assignee will grant to any person the exclusive right to use or sell any subject inventions in the United States unless such person agrees that any products embodying the subject invention or produced through the use of the subject invention will be manufactured substantially in the United States. However, in individual cases, the requirement for such an agreement may be waived by the Federal agency upon a showing by the contractor or its assignee that reasonable but unsuccessful efforts have been made to grant licensees that would be likely to manufacture substantially in the United States or that under the circumstances domestic manufacture is not commercially feasible.

J. March-in Rights

The contractor agrees that with respect to any subject invention in which it has acquired title, the Federal agency has the right in accordance with the procedures in 37 CFR 401.6

and any supplemental regulations of the agency to require the contractor, an assignee or exclusive licensee of a subject invention to grant a nonexclusive, partially exclusive, or exclusive license in any field of use to a responsible applicant or applicants, upon terms that are reasonable under the circumstances, and if the contractor, assignee, or exclusive licensee refuses such a request the Federal agency has the right to grant such a license itself if the Federal agency determines that:

1. Such action is necessary because the contractor or assignee has not taken, or is not expected to take within a reasonable time, effective steps to achieve practical application of the subject invention in such field of use.
2. Such action is necessary to alleviate health or safety needs which are not reasonably satisfied by the contractor, assignee or their licensees:
3. Such action is necessary to meet requirements for public use specified by Federal regulations and such requirements are not reasonably satisfied by the contractor, assignee or licensees; or
4. Such action is necessary because the agreement required by paragraph (I) of this clause has not been obtained or waived or because a licensee of the exclusive right to use or sell any subject invention in the United States is in breach of such agreement.

K. Special Provisions for Contracts with Nonprofit Organizations

If the Contractor is a nonprofit organization, it agrees that:

1. Rights to a subject invention in the United States may not be assigned without the approval of the Federal agency, except where such assignment is made to an organization which has as one of its primary functions the management of inventions, provided that such assignee will be subject to the same provisions as the contractor.
2. The contractor will share royalties collected on a subject invention with the inventor, including Federal employee co-inventors (when the agency deems it appropriate) when the subject invention is assigned in accordance with 35 U.S.C. 202(e) and 37 CFR 401.10;
3. The balance of any royalties or income earned by the contractor with respect to subject inventions, after payment of expenses (including payments to inventors) incidental to the administration of subject inventions, will be utilized for the support of scientific research or education; and
4. It will make efforts that are reasonable under the circumstances to attract licensees of subject invention that are small business firms and that it will give a preference to a small business firm when licensing a subject invention if the contractor determines that the small business firm has a plan or proposal for marketing the invention

which, if executed, is equally as likely to bring the invention to practical application as any plans or proposals from applicants that are not small business firms; provided, that the contractor is also satisfied that the small business firm has the capability and resources to carry out its plan or proposal. The decision whether to give a preference in any specific case will be at the discretion of the contractor. However, the contractor agrees that the Secretary may review the contractor's licensing program and decisions regarding small business applicants, and the contractor will negotiate changes to its licensing policies, procedures, or practices with the Secretary when the Secretary's review discloses that the contractor could take reasonable steps to implement more effectively the requires of this paragraph (K)(4).

1. Communication

(Complete According to Instruction at 401.5(b))

(b) When the Department of Energy (DOE) determines to use alternative provisions under § 401.3(a)(4), the standard clause at § 401.14(a), above, shall be used with the following modifications unless a substitute clause is drafted by DOE:

(1) The title of the clause shall be changed to read as follows: Patent Rights to Nonprofit DOE Facility Operators

(2) Add an "(A)" after "(1)" in paragraph (c)(1) and add subparagraphs (B) and (C) to paragraph (c)(1) as follows:

(B) If the subject invention occurred under activities funded by the naval nuclear propulsion or weapons related programs of DOE, then the provisions of this subparagraph (c)(1)(B) will apply in lieu of paragraphs (c)(2) and (3). In such cases the contractor agrees to assign the government the entire right, title, and interest thereto throughout the world in and to the subject invention except to the extent that rights are retained by the contractor through a greater rights determination or under paragraph (e), below. The contractor, or an employee-inventor, with authorization of the contractor, may submit a request for greater rights at the time the invention is disclosed or within a reasonable time thereafter. DOE will process such a request in accordance with procedures at 37 CFR 401.15. Each determination of greater rights will be subject to paragraphs (h)-(k) of this clause and such additional conditions, if any, deemed to be appropriate by the Department of Energy.

(C) At the time an invention is disclosed in accordance with (c)(1)(A) above, or within 90 days thereafter, the contractor will submit a written statement as to whether or not the invention occurred under a naval nuclear propulsion or weapons-related program of the Department of Energy. If this statement is not filed within this time,

subparagraph (c)(1)(B) will apply in lieu of paragraphs (c)(2) and (3). The contractor statement will be deemed conclusive unless, within 60 days thereafter, the Contracting Officer disagrees in writing, in which case the determination of the Contracting Officer will be deemed conclusive unless the contractor files a claim under the Contract Disputes Act within 60 days after the Contracting Officer's determination. Pending resolution of the matter, the invention will be subject to subparagraph (c)(1)(B).

3. Paragraph (k)(3) of the clause will be modified as prescribed at § 401.5(g).

§ 401.15 Deferred Determinations

- (a) This section applies to requests for greater rights in subject inventions made by contractors when deferred determination provisions were included in the funding agreement because one of the exceptions at § 401.3(a) was applied, except that the Department of Energy is authorized to process deferred determinations either in accordance with its waiver regulations or this section. A contractor requesting greater rights should include with its request information on its plans and intentions to being the invention to practical application. Within 90 days after receiving a request and supporting information, or sooner if a statutory bar to patenting is imminent, the agency should seek to make a determination. In any event, if a bar to patenting is imminent, unless the agency plans to file on its own, it shall authorize the contractor to file a patent application pending a determination by the agency. Such a filing shall normally be at the contractor's own risk and expense. However, if the agency subsequently refuses to allow the contractor to retain title and elects to proceed with the patent application under government ownership, it shall reimburse the contractor for the cost of preparing and filing the patent application.
- (b) If the circumstances of concerns which originally led the agency to invoke an exception under § 401.3(a) are not applicable to the actual subject invention or are no longer valid because of subsequent events, the agency should allow the contractor to retain title to the invention on the same conditions as would have applied if the standard clause at § 401.14(a) had been used originally, unless it has been licensed.
- (c) If paragraph (b) is not applicable, the agency shall make its determination based on an assessment whether its own plans regarding the invention will better promote the policies and objectives of 35 U.S.C. 200 than will contractor ownership of the invention. Moreover, if the agency is concerned only about specific uses or applications of the invention, it shall consider leaving title in the contractor with additional conditions imposed upon the

contractor's use of the invention for such applications or with expanded government license rights in such applications.

- (d) A determination not to allow the contractor to retain title to a subject invention or to restrict or condition its title with conditions differing from those in the clause at § 401.14(a), unless made by the head of the agency, shall be appealable by the contractor to an agency official at a level above the person who made the determination. This appeal shall be subject to the procedures applicable to appeals under § 401.11 of this part.

§ 401.16 Submissions and Inquiries

All submissions or inquiries should be directed to Federal Technology Management Policy Division, telephone number 202-377-0659, Room H4837, U.S. Department of Commerce, Washington, DC 20230
(FR Doc. 87-5618 Filed 3-17-87: 8:45 am)

COPYRIGHT REQUIREMENTS

Awarding agency requirements and regulations pertaining to copyrights and rights in data.

COPYRIGHTS

Federally supported grant research projects frequently result in the production of books, brochures, manuals, articles, films, or other written materials. In most instances they are technical reports which serve to disseminate the results of a project to the public and to the scientific community or other researchers. Often, however, these documents are publishable and occasionally they have significant commercial value. Who controls the rights to these materials? What rights does the Government retain? What are the grantee's responsibilities in handling the materials?

There is a widely held notion that written materials produced with the support of public money are automatically in the public domain. That view is erroneous, and in fact no member of the public has an inherent right to use grant-produced materials merely because they were prepared under Government assistance. Because of the confusion, however, it is important for grantees to note a few features of the copyright law which relate to the subject of the grants.

In general, researchers have exclusive rights in any original works of their authorship. Under the most recent amendment to the copyright law, statutory copyright protection extends to both published and unpublished works of the author. Researchers are cautioned to observe the publication policies of their institutions or organizations in this regard, and unless there is an express agreement to the contrary, their employing institution may be considered the author of any materials prepared in the course of their employment, under the "works for hire" doctrine.

Under the most recent amendments to the copyright law, it is clear that grant reports are not considered works of the Government which are in the public domain. The legislative history of the law shows that Congress expressly left it to the discretion of the individual grant-making agencies to determine whether written materials produced by their grantees should be placed in the public domain, and it expected the questions to be resolved by the terms and conditions of grants. The House Report No. 94-1476, September 3, 1976, stated on page 59:

A more difficult and far-reaching problem is whether the definition should be broadened to prohibit copyright in works prepared under U.S. Government contract or grant. As the bill is written, the Government agency concerned could determine in each case whether to allow an independent contractor or grantee to secure copyright in works prepared in whole or in part with the use of Government funds. The argument that has been made against allowing copyright in this situation is that the public should not be required to pay a "double subsidy," and that it is inconsistent to prohibit copyright in works by Government employees while permitting private copyrights in a growing body of works created by persons who are paid with Government funds. Those arguing in favor of potential copyright protection have stressed the importance of copyright as an incentive to creation and dissemination in this situation, and the basically different policy considerations, applicable to works

written by Government employees and those applicable to works prepared by private organizations with the use of Federal funds.

The bill deliberately avoids making any sort of outright, unqualified prohibition against copyright in works prepared under Government contract or grant. There may be cases where it would be in the public interest to deny copyright in the writings generated by Government research contracts and the like; it can be assumed that, where a Government agency commissions a work for its own use merely as an alternative to having one of its own employees prepare the work, the right to secure a private copyright would be withheld. However, there are almost certainly many other cases where the denial of copyright protection would be unfair or would hamper the production and publication of important works. Where, under the particular circumstances, Congress or the agency involved finds the need to have a work freely available outweighs the need of the private author to secure copyright, the problem can be dealt with by specific legislation, agency regulations, or contractual restrictions.

Agency Policy

Government-wide policies contained in Office of Management and Budget Circulars A-102 and A-110 speak to the issue of copyrightable materials through their respective Attachments N. Circular A-110 states:

8b. Copyrights. - Except as otherwise provided in the terms and conditions of the agreement, the author or the recipient organization is free to copyright any books, publications, or other copyrightable materials developed in the course of or under a Federal agreement, but the Federal sponsoring agency shall reserve a royalty-free, nonexclusive and irrevocable right to reproduce, publish, or otherwise use, and to authorize others to use, the work for Government purposes.

Except for minor, nonsubstantive differences, the provisions of A-102 are identical. Each permits the grantee to copyright published materials, subject to a license for the U.S. Government to use the materials for Government purposes. Each also gives the grantor agency discretion in altering that condition, by establishing different terms and conditions in its grants.

Suggested steps for grantees

A grantee whose grant-financed activity may involve the need for potential need for copyrighting of materials should:

- Check the terms and conditions of the grant to determine whether a copyright can be asserted in unpublished as well as published materials. This may vary from grantor agency to grantor agency and from grant to grant.
- It is the grantee's obligation to take the necessary steps to preserve the Government's license when conveying rights to publishers. If the publisher provides a release form

that does not contain a reference to Government use of the materials, appropriate language should be inserted that preserves the Government's rights. If necessary, the granting agency should be consulted to assure compliance with the terms of the grant.

- Under most Federal grants, proper acknowledgment of the source of funds used to write a published work will be required. For example, the National Science Foundation **Grant General Conditions** require the following acknowledgment of support and disclaimer statement in any publication of material, whether copyrighted or not: "This material is based upon work supported by the National Science Foundation under Grant No. _____." Except for scientific articles and papers appearing in scientific journals, all materials must also contain the following disclaimer:

Any opinions, findings and conclusions or recommendations expressed in this publication are those of the author(s) and do not necessarily reflect the views of the National Science Foundation.

- When negotiating a publication agreement, the grantee must include in the publishing contract the reservation of Government license and the acknowledgment and disclaimer statements.
- Grants often are made with the stipulation that any substantive technical reports will be made available to the public through the U.S. Department of Commerce, National Technical Information Service (NTIS). Again, the grantee is well advised to check the terms and conditions of its grant agreement to see if such requirements exist and, if so, to account for them in dealing with potential publishers.
- Provide copies of copyrighted work to the granting agency.
- Some agencies may require prior approval of any proposed commercial publication, including approval of the selection process by which a publisher is obtained. The National Science Foundation, for example, requires documentation showing that a reasonable number of qualified publishers were given an opportunity to compete for the materials. Also, the selection criteria are subject to examination, as well as the final publishing contract.

With respect to any discovery or invention which arises or is developed in the course of or under this contract, Lexington-Fayette Urban County Government and/or Owner shall have the right to require the contractor, an assignee or exclusive licensee of a subject invention to grant a non-exclusive, partially exclusive, or exclusive license in any field of use to Lexington-Fayette Urban County Government and/or Owner.

With respect to any copyrights and rights in data, Lexington-Fayette Urban County Government and/or Owner shall have the right to retain all copyrights and rights in data.

ACCESS TO RECORDS REQUIREMENTS

Access by the grantee, the subgrantee, the Federal grantor agency, the Comptroller General of the United States, or any of their duly authorized representatives to any books, documents, papers, and records of the contractor which are directly pertinent to that specific contract for the purpose of making audit, examination, excerpts, and transcriptions.

ACCESS TO RECORDS

The Contractor agrees that the Lexington-Fayette Urban County Government, the Owner, the Comptroller General of the United States, or any of their duly authorized representatives, shall have access to any and all books, documents, papers, and records of the Contractor which are directly pertinent to this specific project for the purposes of making an audit, examination, excerpts, and transcriptions.

RECORDS RETENTION REQUIREMENTS

Retention of all required records for three years after contractors or subcontractors make final payments and all other pending matters are closed.

CONTRACT AWARD RESTRICTION TO FOREIGN COUNTRIES

Contractor agrees to fully comply with applicable terms and conditions in Section 109 of Pub. L. 100-102 as set forth below:

RESTRICTIONS ON PUBLIC BUILDINGS AND PUBLIC WORKS PROJECTS

(A) Definitions. "Component" as used in this clause means those articles, materials, and supplies incorporated directly into the product.

"Contractor or subcontractor of a foreign country," as used in this clause, means any Contractor or Subcontractor that is a citizen or national of a foreign country or is controlled directly or indirectly by citizens or nationals of a foreign country. A contractor or subcontractor shall be considered to be a citizen or national of a foreign country or controlled directly or indirectly by citizens or nationals of a foreign country.

- (1) If 50 percent or more of the Contractor or Subcontractor is owned by a citizen or a national of the foreign country;
- (2) If the title of to 50 percent or more of the stock of the Contractor or Subcontractor is held subject to trust or fiduciary obligation in favor of citizens or nationals of the foreign country;
- (3) If 50 percent or more of the voting power in the Contractor-Subcontractor is vested in or exercisable on behalf of a citizen or national of the foreign country;
- (4) In the case of a partnership, if any general partner is a citizen of the foreign country;
- (5) In the case of a corporation, if its president or other chief executive officer or the chairman of its board of directors is a citizen of the foreign country or the majority of any number of its directors necessary to constitute a quorum are citizens of the foreign country or the corporation is organized under the laws of the foreign country or any subdivision, territory, or possession thereof; or
- (6) In the case of a Contractor or Subcontractor who is a joint venture, if any participant firm is a citizen or national of a foreign country or meets any of the criteria in subparagraphs (a)(1) through (5) of this clause.

"Product", as used in this clause, means construction materials-i.e., articles, materials, and supplies brought to the construction site for incorporation into the public works project, including permanently affixed equipment, instruments, utilities, electronic or other devices, but not including vehicles or construction equipment. In determining the origin of a product Lexington-Fayette Urban County Government and/or Owner will consider a product as produced in a foreign country if it has been assembled or manufactured in the foreign country, or if the cost of the components mined, produced, or manufactured in the foreign country exceed 50 percent of the cost of all its components.

- (b) Restrictions. The Contractor shall not (1) knowingly enter into any subcontract under this contract with a Subcontractor of a foreign country on the list of countries that discriminate against U.S. firms published by the United States Trade Representative (see paragraph (c) of this clause, or (2) supply any product under this contract of a country included on the list of foreign countries that discriminate against U.S. firms published by the USTR.
- (c) USTR list. The USTR published an initial list in the Federal Register on December 30, 1987 (53 FR 49244), which identified one country - Japan. The USTR can add other countries to the list or remove countries from it in accordance with Section 109 (c) of Pub. L 100-202.
- (d) Certification. The Contractor may rely upon the certification of a prospective Subcontractor that it is not a Subcontractor of a foreign country included on the list of countries that discriminate against U.S. firms published by the USTR and that products supplied by such Subcontractor for use on the Federal public works project under this contract are not products of a foreign country included on the list of foreign countries that discriminate against U.S. firms published by the USTR, unless such Contractor has knowledge that the certification is erroneous.
- (e) Subcontracts. The Contractor shall incorporate this clause, modified only for the purpose of properly identifying the parties in all subcontracts. This paragraph (e) shall also be incorporated in all subcontracts.

(End of Contract Clause)

Bids/proposals from such firms/suppliers shall be deemed nonresponsible and rejected.

Questions related to this issue should be directed to Division of Community Development, Lexington-Fayette Urban County Government, 200 E. Main Street 6th Floor, Lexington, Kentucky 40507.

KENTUCKY EQUAL EMPLOYMENT OPPORTUNITY ACT

The Kentucky Equal Employment Opportunity Act of 1978 (KRS 45.570-45.640) requires that any county, city, town, school district, water district, hospital district, or other political subdivision of the state shall include in directly or indirectly publicly funded contracts for supplies, materials, services or equipment hereinafter entered into the following provisions:

During the performance of this contract, the contractor agrees as follows:

1. The contractor will not discriminate against any employee or applicant for employment because of race, color, religion, sex, age, or national origin;
2. The contractor will state in all solicitations or advertisements for employees placed by or on behalf of the contractor that all qualified applicants will receive consideration for employment without regard to race, color, religion, sex, age, or national origin;
3. The contractor will post notices in conspicuous places, available to employees and applicants for employment, setting forth the provisions of the nondiscrimination clauses required by this section; and
4. The contractor will send a notice to each labor union or representative of workers with which he has a collective bargaining agreement or other contract or understanding advising the labor union or worker's representative of the contractor's commitments under the non discrimination clauses.

The Act further provides:

KRS 45.610. Hiring Minorities - Information Required

1. For the length of the contract, each contractor shall hire minorities from other sources within the drawing area, should the union with which he has collective bargaining agreements be unwilling to supply sufficient minorities to satisfy the agreed upon goals and timetables.
2. Each contractor shall, for the length of the contract, furnish such information as required by KRS 45.560 to KRS 45.640 and by such rules, regulations and orders issued pursuant thereto and will permit access to all books and records pertaining to his employment practices and work sites by the contracting agency and the department for purposes of investigation to ascertain compliance with KRS 45.560 to KRS 45.640 and such rules, regulations and orders issued pursuant thereto.

KRS 45.620. Action Against Contractor -- Hiring of Minority Contractor or Subcontractor

1. If any contractor is found by the department to have engaged in an unlawful practice under this chapter during the course of performing under a contract or subcontract

covered under KRS 45.560 to 45.640, the department shall so certify to the contracting agency and such certifications shall be binding upon the contracting agency unless it is reversed in the course of judicial review.

2. If the contractor is found to have committed an unlawful practice under KRS 45.560 to 45.640, the contracting agency may cancel or terminate the contract, conditioned upon a program for future compliance approved by the contracting agency and the department. The contracting agency may declare such a contractor ineligible to bid on further contracts with that agency until such time as the contractor complies in full with the requirements of KRS 45.560 to 45.640.
3. The equal employment provisions of KRS 45.560 to 45.640 may be met in part by a contractor by subcontracting to a minority subcontractor or subcontractor. For the provisions of KRS 45.560 to 45.640, a minority contractor or subcontractor shall mean a business that is owned and controlled by one or more persons disadvantaged by racial or ethnic circumstances.

KRS 45.630. Termination of existing employee not required, when:

Any provision of KRS 45.560 to 45.640 notwithstanding, no contractor shall be required to terminate an existing employee, upon proof that the employee was employed prior to the date of the contract.

KRS 45.640. Minimum Skills

Nothing in KRS 45.560 to 45.640 shall require a contractor to hire anyone who fails to demonstrate the minimum skills required to perform a particular job.

OTHER FEDERAL REQUIREMENTS

INTEREST OF CERTAIN FEDERAL OFFICIALS

No member of or Delegate to the Congress of the United States and no Resident Commission, shall be admitted to any share or part of this Agreement or to any benefit to arise from the same.

INTEREST OF MEMBERS, OFFICERS, OR EMPLOYEES OF PUBLIC BODY, MEMBER OF LOCAL GOVERNING BODY, OR OTHER PUBLIC OFFICIALS

No member, officer, or employee of the Public Body, or its designees or agents, no member of the governing body of the locality in which the program is situated, and no other public official of such locality or localities who exercises any functions or responsibilities with respect to the program during his tenure or for one year thereafter, shall have any interest, direct or indirect, in any contract or sub-contract, or the proceeds thereof, for work to be performed in connection with the program assisted under this Agreement.

PROHIBITION AGAINST PAYMENTS OF BONUS OR COMMISSION

The assistance provided under this Agreement shall not be used in the payment of any bonus or commission for the purpose of obtaining Federal approval of the application for such assistance, or approval of applications for additional assistance, or any other approval of concurrence required under this Agreement with respect thereto; provided, however, that reasonable fees or bonafide technical, consultant, managerial or other such services, other than actual solicitation, are not hereby prohibited if otherwise eligible as program costs.

PUBLIC LAW 88-352: TITLE VI OF THE CIVIL RIGHTS
ACT OF 1964

The Developer agrees to insure that no person shall on the ground of race, color, or national origin, be excluded from participation in, be denied the benefits of, or be subjected to discrimination under any program in the multi-family rental housing facility developed through this contract.

PUBLIC LAW 90-284: TITLE VIII OF THE CIVIL RIGHTS ACT
OF 1968 AND EXECUTIVE ORDER 11063

The Developer warrants and assures that they and their agents will not discriminate in the rental or leasing of housing units constructed under this contract and will in no way make unavailable or deny a dwelling to any person, because of race, color, religion, sex or national origin.

SECTION 109

The Developer will not on the ground of race, color, national origin, sex, age, or handicap:

1. Deny an facilities, services, financial aid or other benefits provided under the program or activity.
2. Provide any facilities, services, financial aid or other benefits which are different, or are provided in a different form from that provided to others under the program or activity.
3. Subject to segregated or separate treatment in any facility in, or in any matter of process related to receipt of any service or benefit under the program or activity.
4. Restrict in any way access to, or in the enjoyment of any advantage or privilege enjoyed by others in connection with facilities, services, financial aid or other benefits under the program or activity.
5. Treat any individual differently from others in determining whether the individual satisfies any admission, enrollment, eligibility, membership, or other requirement or condition which individual must meet in order to be provided any facilities, services or other benefit provided under the program or activity.
6. Deny an opportunity to participate in a program or activity as an employee.

COMPLIANCE WITH THE CLEAN AIR AND WATER ACTS

Compliance with all applicable standards, orders, or requirements issued under section 206 of the Clean Air Act (42 U.S.C. 1857)(h), Section 506 of the Clean Water Act (33 U.S.C. 1368), Executive Order 11738, and Environmental Protection Agency regulations (40 CFR Part 15). (Contracts, subcontracts, and subgrants of amounts in excess of \$100,000).

COMPLIANCE WITH AIR AND WATER ACTS

This Agreement is subject to the requirements of the Clean Air Act, as amended, 42 USC 1857 et. seq., the Federal Water Pollution Control Act, as amended, 33 U.S.C. 1251 et seq. and the regulations of the Environmental Protection Agency with respect thereto, at 40 CFR Part 15, as amended from time to time.

The Contractor and any of its subcontractors for work funded under this Agreement, in excess of \$100,000 agree to the following requirements:

1. A stipulation by the Contractor or subcontractors that any facility to be utilized in the performance of any non-exempt contract or subcontract is not listed on the List of Violating Facilities issued by the Environmental Protection Agency (EPA) pursuant to 40 CFR 15.20.
2. Agreement by the Contractor to comply with all requirements of Section 114 of the Clean Air Act, as amended, (42 U.S.C. 1857c-8) and Section 308 of the Federal Water Pollution Control Act, as amended, (33 U.S.C. 1318) relating to inspection, monitoring, entry, reports and information, as well as all other requirements specified in said Section 114 and Section 308, and all regulations and guidelines issued there under.
3. A stipulation that as a condition for the award of the Contract prompt notice will be given of any notification received from the Director, Office of Federal Activities, EPA indicating that a facility utilized or to be utilized for the Contract is under consideration to be listed on the EPA list of Violating Facilities.
4. Agreement by the Contractor that he/she will include or cause to be included the criteria and requirements in paragraph (1) through (4) of this section in every nonexempt subcontract and requiring that the Contractor will take such action as the Government may direct as a means of enforcing such provision.

In no event shall any amount of assistance provided under this Agreement be utilized with respect to a facility which has given rise to a conviction under Section 113(c)(1) of the Clean Air Act or Section 309(c) of the Federal Water Pollution Control Act.

ENERGY EFFICIENCY REQUIREMENTS

Mandatory standards and policies relating to energy efficiency which are contained in the state energy conservation plan issued in compliance with the Energy Policy and Conservation Act (Pub. L.94-163).

LEAD BASED PAINT

- A. All paint to be lead free.
- B. Existing lead paint to be removed or concealed with an acceptable covering (paint, siding, etc.)
- C. Warning
 - 1. Use of lead-base paint materials on any surface, interior or exterior, is prohibited.
 - 2. Lead-base paint removal is a dangerous task and safety precautions should be strictly enforced when workers are engaged in hazard abatement.

POTENTIAL DBE CONTRACTOR'S LIST CONTACT

For a listing of DBE (Disadvantaged Business Enterprise) contractors/subcontractors, please contact:

Sherita Miller/Todd Slatin
Division of Central Purchasing
200 E. Main Street, 3rd Floor
Lexington, KY 40507
(859) 258-3326
TDD [hearing impaired only] (859) 258-3606

EQUAL EMPLOYMENT OPPORTUNITY AFFIRMATIVE ACTION POLICY

It is the policy of
to assure that all applicants for employment and all employees are treated on a fair and equitable basis without regard to their race, religion, sex, color, handicap, natural origin or age.

Such action shall include employment, promotion, demotion, recruitment or recruitment advertising, layoff or termination, rates of pay and other forms of compensation, and selection for training, whether apprenticeship and/or on-the-job-training.

Furthermore, this company agrees to make special recruitment efforts to hire the protected class whenever feasible. This company also agrees to adhere to all applicable federal, state, and local laws relating to Equal Employment Opportunity for all individuals.

_____ has been appointed Equal Employment Compliance (EEOC) Officer and shall be available for counseling, answering of questions in regards to this company policy, and to hear any complaints of discrimination. The EEOC Office may be reached by calling _____.

Signature: _____
(Bidding Contractor)

Title: _____

Date: _____

DEBARMENT CERTIFICATION

All contractors/subcontractors shall complete the following certification and submit it with the bid proposal.

The contractor/subcontractor certifies in accordance with Executive Order 12549 (Debarment and Suspension 2/18/86) that to the best of its knowledge and belief, that it and its principals:

- 1) Are not presently debarred, suspended, proposed for debarment, declared negligible, or voluntarily excluded from covered transactions or contract by any Federal department or agency for noncompliance with the Federal Labor Standards, Title VI of the Civil Rights Act of 1964 as amended, Executive Order 11246 as amended or any other Federal law;
 - a) Have not within a three year period preceding this proposal been convicted of or had a civil judgment rendered against them for commission of fraud or a criminal offense in connection with obtaining, attempting to obtain, or performing a public (Federal, State or local) transaction or contract under a public transaction; violation of Federal or State antitrust statutes or commission of embezzlement, theft, forgery, bribery, falsification or destruction of records, making false statements, or receiving stolen property;
 - b) Are not presently indicted for or otherwise criminally or civilly charged by a government entity (Federal, State or local) with commission of any of the offenses enumerated in paragraph (1)(a) of this certification; and
 - c) Have not within a three year period preceding this bid has one or more public (Federal, State or local) transactions or contracts terminated for cause or default.
- 2) Where the contractor is unable to certify to any of the statements in this certification, such prospective contractors shall attach an explanation to this certification form.

Firm Name: _____

Project: _____

Printed Name and Title of Authorized Representative: _____

Signature: _____

Date: _____

General Decision Number: KY180100 01/19/2018 KY100

Superseded General Decision Number: KY20170100

State: Kentucky

Construction Type: Highway

Counties: Anderson, Bath, Bourbon, Boyd, Boyle, Bracken, Breckinridge, Bullitt, Carroll, Carter, Clark, Elliott, Fayette, Fleming, Franklin, Gallatin, Grant, Grayson, Greenup, Hardin, Harrison, Henry, Jefferson, Jessamine, Larue, Lewis, Madison, Marion, Mason, Meade, Mercer, Montgomery, Nelson, Nicholas, Oldham, Owen, Robertson, Rowan, Scott, Shelby, Spencer, Trimble, Washington and Woodford Counties in Kentucky.

HIGHWAY CONSTRUCTION PROJECTS (excluding tunnels, building structures in rest area projects & railroad construction; bascule, suspension & spandrel arch bridges designed for commercial navigation, bridges involving marine construction; and other major bridges).

Note: Under Executive Order (EO) 13658, an hourly minimum wage of \$10.35 for calendar year 2018 applies to all contracts subject to the Davis-Bacon Act for which the contract is awarded (and any solicitation was issued) on or after January 1, 2015. If this contract is covered by the EO, the contractor must pay all workers in any classification listed on this wage determination at least \$10.35 per hour (or the applicable wage rate listed on this wage determination, if it is higher) for all hours spent performing on the contract in calendar year 2018. The EO minimum wage rate will be adjusted annually. Please note that this EO applies to the above-mentioned types of contracts entered into by the federal government that are subject to the Davis-Bacon Act itself, but it does not apply to contracts subject only to the Davis-Bacon Related Acts,

including those set forth at 29 CFR 5.1(a)(2)-(60). Additional information on contractor requirements and worker protections under the EO is available at www.dol.gov/whd/govcontracts.

Modification Number Publication Date

0 01/05/2018
1 01/19/2018

BRIN0004-003 06/01/2017

BRECKENRIDGE COUNTY

	Rates	Fringes
BRICKLAYER.....	\$ 26.80	12.38

BRKY0001-005 06/01/2017

BULLITT, CARROLL, GRAYSON, HARDIN, HENRY, JEFFERSON, LARUE, MARION, MEADE, NELSON, OLDHAM, SHELBY, SPENCER, & TRIMBLE COUNTIES:

	Rates	Fringes
BRICKLAYER.....	\$ 26.80	12.38

BRKY0002-006 06/01/2017

BRACKEN, GALLATIN, GRANT, MASON & ROBERTSON COUNTIES:

	Rates	Fringes
--	-------	---------

BRICKLAYER.....\$ 27.81 13.01

BRKY0007-004 06/01/2017

BOYD, CARTER, ELLIOT, FLEMING, GREENUP, LEWIS & ROWAN COUNTIES:

Rates Fringes

BRICKLAYER.....\$ 32.98 19.02

BRKY0017-004 06/01/2017

ANDERSON, BATH, BOURBON, BOYLE, CLARK, FAYETTE, FRANKLIN,
HARRISON, JESSAMINE, MADISON, MERCER, MONTGOMERY, NICHOLAS,
OWEN, SCOTT, WASHINGTON & WOODFORD COUNTIES:

Rates Fringes

BRICKLAYER.....\$ 26.47 12.76

CARP0064-001 05/01/2015

Rates Fringes

CARPENTER.....\$ 27.50 16.06

Diver.....\$ 41.63 16.06

PILEDRIVERMAN.....\$ 27.75 16.06

ELEC0212-008 06/05/2017

BRACKEN, GALLATIN and GRANT COUNTIES

Rates Fringes

ELECTRICIAN.....\$ 27.90 17.56

ELEC0212-014 12/01/2014

BRACKEN, GALLATIN & GRANT COUNTIES:

Rates Fringes

Sound & Communication

Technician.....\$ 22.75 10.08

ELEC0317-012 06/01/2016

BOYD, CARTER, ELLIOT & ROWAN COUNTIES:

Rates Fringes

ELECTRICIAN (Wiremen)

Cable Splicer.....\$ 32.68 18.13

Electrician.....\$ 33.31 22.98

ELEC0369-007 05/31/2017

ANDERSON, BATH, BOURBON, BOYLE, BRECKINRIDGE, BULLITT, CARROLL,
CLARK, FAYETTE, FRAONKLIN, GRAYSON, HARDIN, HARRISON, HENRY,
JEFFERSON, JESSAMINE, LARUE, MADISON, MARION, MEADE, MERCER,
MONTGOMERY, NELSON, NICHOLAS, OLDHAM, OWEN, ROBERTSON, SCOTT,
SHELBY, SPENCER, TRIMBLE, WASHINGTON, & WOODFORD COUNTIES:

Rates Fringes

ELECTRICIAN.....\$ 31.07 16.60

ELEC0575-002 05/29/2017

FLEMING, GREENUP, LEWIS & MASON COUNTIES:

	Rates	Fringes
ELECTRICIAN.....	\$ 32.15	15.77

ENGI0181-018 07/01/2017

	Rates	Fringes
POWER EQUIPMENT OPERATOR		
GROUP 1.....	\$ 31.95	15.15
GROUP 2.....	\$ 29.09	15.15
GROUP 3.....	\$ 29.54	15.15
GROUP 4.....	\$ 28.77	15.15

OPERATING ENGINEER CLASSIFICATIONS

GROUP 1 - A-Frame Winch Truck; Auto Patrol; Backfiller; Batcher Plant; Bituminous Paver; Bituminous Transfer Machine; Boom Cat; Bulldozer; Mechanic; Cableway; Carry-All Scoop; Carry Deck Crane; Central Compressor Plant; Cherry Picker; Clamshell; Concrete Mixer (21 cu. ft. or Over); Concrete Paver; Truck-Mounted Concrete Pump; Core Drill; Crane; Crusher Plant; Derrick; Derrick Boat; Ditching & Trenching Machine; Dragline; Dredge Operator; Dredge Engineer; Elevating Grader & Loaders; Grade-All; Gurrries; Heavy Equipment Robotics Operator/Mechanic; High Lift; Hoe-Type Machine; Hoist (Two or More Drums); Hoisting Engine (Two or More Drums); Horizontal Directional Drill Operator; Hydrocrane; Hyster; KeCal Loader; LeTourneau;

Locomotive; Mechanic; Mechanically Operated Laser Screed; Mechanic Welder; Mucking Machine; Motor Scraper; Orangepeel Bucket; Overhead Crane; Piledriver; Power Blade; Pumpcrete; Push Dozer; Rock Spreader, attached to equipment; Rotary Drill; Roller (Bituminous); Rough Terrain Crane; Scarifier; Scoopmobile; Shovel; Side Boom; Subgrader; Tailboom; Telescoping Type Forklift; Tow or Push Boat; Tower Crane (French, German & other types); Tractor Shovel; Truck Crane; Tunnel Mining Machines, including Moles, Shields or similar types of Tunnel Mining Equipment

GROUP 2 - Air Compressor (Over 900 cu. ft. per min.); Bituminous Mixer; Boom Type Tamping Machine; Bull Float; Concrete Mixer (Under 21 cu. ft.); Dredge Engineer; Electric Vibrator; Compactor/Self-Propelled Compactor; Elevator (One Drum or Buck Hoist); Elevator (When used to Hoist Building Material); Finish Machine; Firemen & Hoist (One Drum); Flexplane; Forklift (Regardless of Lift Height); Form Grader; Joint Sealing Machine; Outboard Motor Boat; Power Sweeper (Riding Type); Roller (Rock); Ross Carrier; Skid Mounted or Trailer Mounted Concrete Pump; Skid Steer Machine with all Attachments; Switchman or Brakeman; Throttle Valve Person; Tractair & Road Widening Trencher; Tractor (50 H.P. or Over); Truck Crane Oiler; Tugger; Welding Machine; Well Points; & Whirley Oiler

GROUP 3 - All Off Road Material Handling Equipment, including Articulating Dump Trucks; Greaser on Grease Facilities servicing Heavy Equipment

GROUP 4 - Bituminous Distributor; Burlap & Curing Machine; Cement Gun; Concrete Saw; Conveyor; Deckhand Oiler; Grout Pump; Hydraulic Post Driver; Hydro Seeder; Mud Jack; Oiler; Paving Joint Machine; Power Form Handling Equipment; Pump;

Roller (Earth); Steerman; Tamping Machine; Tractor (Under 50 H.P.); & Vibrator

CRANES - with booms 150 ft. & Over (Including JIB), and where the length of the boom in combination with the length of the piling leads equals or exceeds 150 ft. - \$1.00 over Group 1 rate

EMPLOYEES ASSIGNED TO WORK BELOW GROUND LEVEL ARE TO BE PAID 10% ABOVE BASIC WAGE RATE. THIS DOES NOT APPLY TO OPEN CUT WORK.

IRON0044-009 06/01/2017

BRACKEN, GALLATIN, GRANT, HARRISON, ROBERTSON,
BOURBON (Northern third, including Townships of Jackson, Millersburg, Ruddel Mills & Shawhan);
CARROLL (Eastern third, including the Township of Ghent);
FLEMING (Western part, excluding Townships of Beechburg, Colfax, Elizaville, Flemingsburg, Flemingsburg Junction, Foxport, Grange City, Hillsboro, Hilltop, Mount Carmel, Muses Mills, Nepton, Pecksridge, Plummers Landing, Plummers Mill, Poplar Plains, Ringos Mills, Tilton & Wallingford);
MASON (Western two-thirds, including Townships of Dover, Lewisburg, Mays Lick, Maysville, Minerva, Moranburg, Murphysville, Ripley, Sardis, Shannon, South Ripley & Washington);
NICHOLAS (Townships of Barefoot, Barterville, Carlisle, Ellisville, Headquarters, Henryville, Morningglory, Myers & Oakland Mills);
OWEN (Townships of Beechwood, Bromley, Fairbanks, Holbrook, Jonesville, Long Ridge, Lusby's Mill, New, New Columbus, New Liberty, Owenton, Poplar Grove, Rockdale, Sanders, Teresita &

Wheatley);

SCOTT (Northern two-thirds, including Townships of Biddle, Davis, Delaplain, Elmville, Longlick, Muddy Ford, Oxford, Rogers Gap, Sadieville, Skinnersburg & Stonewall)

Rates Fringes

IRONWORKER

Fence Erector.....	\$ 23.76	19.15
Structural.....	\$ 27.60	20.10

IRON0070-006 06/01/2017

ANDERSON, BOYLE, BRECKINRIDGE, BULLITT, FAYETTE, FRANKLIN, GRAYSON, HARDIN, HENRY, JEFFERSON, JESSAMINE, LARUE, MADISON, MARION, MEADE, MERCER, NELSON, OLDHAM, SHELBY, SPENCER, TRIMBLE, WASHINGTON & WOODFORD

BOURBON (Southern two-thirds, including Townships of Austerlity, Centerville, Clintonville, Elizabeth, Hutchison, Littlerock, North Middletown & Paris);

CARROLL (Western two-thirds, including Townships of Carrollton, Easterday, English, Locust, Louis, Prestonville & Worthville);

CLARK (Western two-thirds, including Townships of Becknerville, Flanagan, Ford, Pine Grove, Winchester & Wyandotte);

OWEN (Eastern eighth, including Townships of Glenmary, Gratz, Monterey, Perry Park & Tacketts Mill);

SCOTT (Southern third, including Townships of Georgetown, Great Crossing, Newtown, Stampling Ground & Woodlake);

Rates Fringes

IRONWORKER.....	\$ 28.30	21.85
-----------------	----------	-------

* IRON0769-007 06/01/2017

BATH, BOYD, CARTER, ELLIOTT, GREENUP, LEWIS, MONTGOMERY & ROWAN
CLARK (Eastern third, including townships of Bloomingdale,
Hunt, Indian Fields, Kiddville, Loglick, Rightangele & Thomson);
FLEMING (Townships of Beechburg, Colfax, Elizaville,
Flemingsburg, Flemingsburg Junction, Foxport, Grange City,
Hillsboro, Hilltop, Mount Carmel, Muses Mills, Nepton,
Pecksridge, Plummers Landing, Plummers Mill, Poplar Plains,
Ringos Mills, Tilton & Wallingford);
MASON (Eastern third, including Townships of Helena, Marshall,
Orangeburg, Plumville & Springdale);
NICHOLAS (Eastern eighth, including the Township of Moorefield
Sprout)

Rates Fringes

IRONWORKER

ZONE 1.....	\$ 31.33	23.97
ZONE 2.....	\$ 31.33	23.97
ZONE 3.....	\$ 31.33	23.97

ZONE 1 - (no base rate increase) Up to 10 mile radius of
Union Hall, 1643 Greenup Ave, Ashland, KY.

ZONE 2 - (add \$0.40 per hour to base rate) 10 to 50 mile
radius of Union Hall, 1643 Greenup Ave, Ashland, KY.

ZONE 3 - (add \$2.00 per hour to base rate) 50 mile radius &
over of Union Hall, 1643 Greenup Ave, Ashland, KY.

LABO0189-003 07/01/2016

BATH, BOURBON, BOYD, BOYLE, BRACKEN, CARTER, CLARK, ELLIOTT,
FAYETTE, FLEMING, FRANKLIN, GALLATIN, GRANT, GREENUP, HARRISON,
JESSAMINE, LEWIS, MADISON, MASON, MERCER, MONTGOMERY, NICHOLAS,
OWEN, ROBERTSON, ROWAN, SCOTT, & WOOLFORD COUNTIES

	Rates	Fringes
Laborers:		
GROUP 1.....	\$ 23.14	13.29
GROUP 2.....	\$ 23.39	13.29
GROUP 3.....	\$ 23.44	13.29
GROUP 4.....	\$ 24.04	13.29

LABORERS CLASSIFICATIONS

GROUP 1 - Aging & Curing of Concrete; Asbestos Abatement Worker; Asphalt Plant; Asphalt; Batch Truck Dump; Carpenter Tender; Cement Mason Tender; Cleaning of Machines; Concrete; Demolition; Dredging; Environmental - Nuclear, Radiation, Toxic & Hazardous Waste - Level D; Flagperson; Grade Checker; Hand Digging & Hand Back Filling; Highway Marker Placer; Landscaping, Mesh Handler & Placer; Puddler; Railroad; Rip-rap & Grouter; Right-of-Way; Sign, Guard Rail & Fence Installer; Signal Person; Sound Barrier Installer; Storm & Sanitary Sewer; Swamper; Truck Spotter & Dumper; Wrecking of Concrete Forms; General Cleanup

GROUP 2 - Batter Board Man (Sanitary & Storm Sewer); Brickmason Tender; Mortar Mixer Operator; Scaffold Builder; Burner & Welder; Bushhammer; Chain Saw Operator; Concrete Saw Operator; Deckhand Scow Man; Dry Cement Handler;

Environmental - Nuclear, Radiation, Toxic & Hazardous Waste
 - Level C; Forklift Operator for Masonary; Form Setter;
 Green Concrete Cutting; Hand Operated Grouter & Grinder
 Machine Operator; Jackhammer; Pavement Breaker; Paving
 Joint Machine; Pipelayer; Plastic Pipe Fusion; Power Driven
 Georgia Buggy & Wheel Barrow; Power Post Hole Digger;
 Precast Manhole Setter; Walk-Behind Tamper; Walk-Behind
 Trencher; Sand Blaster; Concrete Chipper; Surface Grinder;
 Vibrator Operator; Wagon Driller

GROUP 3 - Asphalt Luteman & Raker; Gunnite Nozzleman;
 Gunnite Operator & Mixer; Grout Pump Operator; Side Rail
 Setter; Rail Paved Ditches; Screw Operator; Tunnel (Free
 Air); Water Blaster

GROUP 4 - Caisson Worker (Free Air); Cement Finisher;
 Environmental - Nuclear, Radiation, Toxic & Hazardous Waste
 - Levels A & B; Miner & Driller (Free Air); Tunnel Blaster;
 & Tunnel Mucker (Free Air); Directional & Horizontal
 Boring; Air Track Drillers (All Types); Powdermen &
 Blasters; Troxler & Concrete Tester if Laborer is Utilized

 LABO0189-008 07/01/2017

ANDERSON, BULLITT, CARROLL, HARDIN, HENRY, JEFFERSON, LARUE,
 MARION, MEADE, NELSON, OLDHAM, SHELBY, SPENCER, TRIMBLE &
 WASHINGTON COUNTIES

Rates Fringes

Laborers:

GROUP 1.....\$ 23.14 13.29

GROUP 2.....	\$ 23.39	13.29
GROUP 3.....	\$ 23.44	13.29
GROUP 4.....	\$ 24.04	13.29

LABORERS CLASSIFICATIONS

GROUP 1 - Aging & Curing of Concrete; Asbestos Abatement Worker; Asphalt Plant; Asphalt; Batch Truck Dump; Carpenter Tender; Cement Mason Tender; Cleaning of Machines; Concrete; Demolition; Dredging; Environmental - Nuclear, Radiation, Toxic & Hazardous Waste - Level D; Flagperson; Grade Checker; Hand Digging & Hand Back Filling; Highway Marker Placer; Landscaping, Mesh Handler & Placer; Puddler; Railroad; Rip-rap & Grouter; Right-of-Way; Sign, Guard Rail & Fence Installer; Signal Person; Sound Barrier Installer; Storm & Sanitary Sewer; Swamper; Truck Spotter & Dumper; Wrecking of Concrete Forms; General Cleanup

GROUP 2 - Batter Board Man (Sanitary & Storm Sewer); Brickmason Tender; Mortar Mixer Operator; Scaffold Builder; Burner & Welder; Bushhammer; Chain Saw Operator; Concrete Saw Operator; Deckhand Scow Man; Dry Cement Handler; Environmental - Nuclear, Radiation, Toxic & Hazardous Waste - Level C; Forklift Operator for Masonary; Form Setter; Green Concrete Cutting; Hand Operated Grouter & Grinder Machine Operator; Jackhammer; Pavement Breaker; Paving Joint Machine; Pipelayer; Plastic Pipe Fusion; Power Driven Georgia Buggy & Wheel Barrow; Power Post Hole Digger; Precast Manhole Setter; Walk-Behind Tamper; Walk-Behind Trencher; Sand Blaster; Concrete Chipper; Surface Grinder; Vibrator Operator; Wagon Driller

GROUP 3 - Asphalt Luteman & Raker; Gunnite Nozzleman; Gunnite Operator & Mixer; Grout Pump Operator; Side Rail

Setter; Rail Paved Ditches; Screw Operator; Tunnel (Free Air); Water Blaster

GROUP 4 - Caisson Worker (Free Air); Cement Finisher; Environmental - Nuclear, Radiation, Toxic & Hazardous Waste - Levels A & B; Miner & Driller (Free Air); Tunnel Blaster; & Tunnel Mucker (Free Air); Directional & Horizontal Boring; Air Track Drillers (All Types); Powdermen & Blasters; Troxler & Concrete Tester if Laborer is Utilized

LABO0189-009 07/01/2014

BRECKINRIDGE & GRAYSON COUNTIES

	Rates	Fringes
Laborers:		
GROUP 1.....	\$ 22.66	11.10
GROUP 2.....	\$ 22.91	11.10
GROUP 3.....	\$ 22.96	11.10
GROUP 4.....	\$ 23.56	11.10

LABORERS CLASSIFICATIONS

GROUP 1 - Aging & Curing of Concrete; Asbestos Abatement Worker; Asphalt Plant; Asphalt; Batch Truck Dump; Carpenter Tender; Cement Mason Tender; Cleaning of Machines; Concrete; Demolition; Dredging; Environmental - Nuclear, Radiation, Toxic & Hazardous Waste - Level D; Flagperson; Grade Checker; Hand Digging & Hand Back Filling; Highway Marker Placer; Landscaping, Mesh Handler & Placer; Puddler; Railroad; Rip-rap & Grouter; Right-of-Way; Sign, Guard Rail & Fence Installer; Signal Person; Sound Barrier Installer;

Storm & Sanitary Sewer; Swamper; Truck Spotter & Dumper;
Wrecking of Concrete Forms; General Cleanup

GROUP 2 - Batter Board Man (Sanitary & Storm Sewer);
Brickmason Tender; Mortar Mixer Operator; Scaffold Builder;
Burner & Welder; Bushhammer; Chain Saw Operator; Concrete
Saw Operator; Deckhand Scow Man; Dry Cement Handler;
Environmental - Nuclear, Radiation, Toxic & Hazardous Waste
- Level C; Forklift Operator for Masonary; Form Setter;
Green Concrete Cutting; Hand Operated Grouter & Grinder
Machine Operator; Jackhammer; Pavement Breaker; Paving
Joint Machine; Pipelayer; Plastic Pipe Fusion; Power Driven
Georgia Buggy & Wheel Barrow; Power Post Hole Digger;
Precast Manhole Setter; Walk-Behind Tamper; Walk-Behind
Trencher; Sand Blaster; Concrete Chipper; Surface Grinder;
Vibrator Operator; Wagon Driller

GROUP 3 - Asphalt Luteman & Raker; Gunnite Nozzleman;
Gunnite Operator & Mixer; Grout Pump Operator; Side Rail
Setter; Rail Paved Ditches; Screw Operator; Tunnel (Free
Air); Water Blaster

GROUP 4 - Caisson Worker (Free Air); Cement Finisher;
Environmental - Nuclear, Radiation, Toxic & Hazardous Waste
- Levels A & B; Miner & Driller (Free Air); Tunnel Blaster;
& Tunnel Mucker (Free Air); Directional & Horizontal
Boring; Air Track Drillers (All Types); Powdermen &
Blasters; Troxler & Concrete Tester if Laborer is Utilized

PAIN0012-005 06/11/2005

BATH, BOURBON, BOYLE, CLARK, FAYETTE, FLEMING, FRANKLIN,
HARRISON, JESSAMINE, MADISON, MERCER, MONTGOMERY, NICHOLAS,

ROBERTSON, SCOTT & WOODFORD COUNTIES:

	Rates	Fringes
PAINTER		
Bridge/Equipment Tender and/or Containment Builder..	\$ 18.90	5.90
Brush & Roller.....	\$ 21.30	5.90
Elevated Tanks; Steeplejack Work; Bridge & Lead Abatement.....	\$ 22.30	5.90
Sandblasting & Waterblasting.....	\$ 22.05	5.90
Spray.....	\$ 21.80	5.90

PAIN0012-017 05/01/2015

BRACKEN, GALLATIN, GRANT, MASON & OWEN COUNTIES:

	Rates	Fringes
PAINTER (Heavy & Highway Bridges - Guardrails - Lightpoles - Striping)		
Bridge Equipment Tender and Containment Builder.....	\$ 20.73	9.06
Brush & Roller.....	\$ 23.39	9.06
Elevated Tanks; Steeplejack Work; Bridge & Lead Abatement.....	\$ 24.39	9.06
Sandblasting & Water Blasting.....	\$ 24.14	9.06
Spray.....	\$ 23.89	9.06

PAIN0118-004 06/01/2014

ANDERSON, BRECKINRIDGE, BULLITT, CARROLL, GRAYSON, HARDIN,
HENRY, JEFFERSON, LARUE, MARION, MEADE, NELSON, OLDHAM, SHELBY,
SPENCER, TRIMBLE & WASHINGTON COUNTIES:

Rates Fringes

PAINTER

Brush & Roller.....\$ 18.50	11.97
Spray, Sandblast, Power Tools, Waterblast & Steam Cleaning.....\$ 19.50	11.97

PAIN1072-003 12/01/2017

BOYD, CARTER, ELLIOTT, GREENUP, LEWIS and ROWAN COUNTIES

Rates Fringes

Painters:

Bridges; Locks; Dams; Tension Towers & Energized Substations.....\$ 33.33	15.45
Power Generating Facilities.\$ 30.09	15.45

PLUM0248-003 06/01/2017

BOYD, CARTER, ELLIOTT, GREENUP, LEWIS & ROWAN COUNTIES:

Rates Fringes

Plumber and Steamfitter.....\$ 35.00 25.12

PLUM0392-007 06/01/2014

BRACKEN, CARROLL (Eastern Half), GALLATIN, GRANT, MASON, OWEN &
ROBERTSON COUNTIES:

Rates Fringes

Plumbers and Pipefitters.....\$ 29.80 17.79

PLUM0502-003 08/01/2017

BRECKINRIDGE, BULLITT, CARROLL (Western Half), FRANKLIN
(Western three-fourths), GRAYSON, HARDIN, HENRY, JEFFERSON,
LARUE, MARION, MEADE, NELSON, OLDHAM, SHELBY, SPENCER, TRIMBLE &
WASHINGTON COUNTIES

Rates Fringes

PLUMBER.....\$ 33.12 20.78

SUKY2010-160 10/08/2001

Rates Fringes

Truck drivers:

GROUP 1.....\$ 16.57	7.34
GROUP 2.....\$ 16.68	7.34
GROUP 3.....\$ 16.86	7.34
GROUP 4.....\$ 16.96	7.34

TRUCK DRIVER CLASSIFICATIONS

GROUP 1 - Mobile Batch Truck Tender

GROUP 2 - Greaser; Tire Changer; & Mechanic Tender

GROUP 3 - Single Axle Dump; Flatbed; Semi-trailer or Pole Trailer when used to pull building materials and equipment; Tandem Axle Dump; Distributor; Mixer; & Truck Mechanic

GROUP 4 - Euclid & Other Heavy Earthmoving Equipment & Lowboy; Articulator Cat; 5-Axle Vehicle; Winch & A-Frame when used in transporting materials; Ross Carrier; Forklift when used to transport building materials; & Pavement Breaker

WELDERS - Receive rate prescribed for craft performing operation to which welding is incidental.

Note: Executive Order (EO) 13706, Establishing Paid Sick Leave for Federal Contractors applies to all contracts subject to the Davis-Bacon Act for which the contract is awarded (and any solicitation was issued) on or after January 1, 2017. If this contract is covered by the EO, the contractor must provide employees with 1 hour of paid sick leave for every 30 hours they work, up to 56 hours of paid sick leave each year. Employees must be permitted to use paid sick leave for their own illness, injury or other health-related needs, including preventive care; to assist a family member (or person who is like family to the employee) who is ill, injured, or has other

health-related needs, including preventive care; or for reasons resulting from, or to assist a family member (or person who is like family to the employee) who is a victim of, domestic violence, sexual assault, or stalking. Additional information on contractor requirements and worker protections under the EO is available at www.dol.gov/whd/govcontracts.

Unlisted classifications needed for work not included within the scope of the classifications listed may be added after award only as provided in the labor standards contract clauses (29CFR 5.5 (a) (1) (ii)).

The body of each wage determination lists the classification and wage rates that have been found to be prevailing for the cited type(s) of construction in the area covered by the wage determination. The classifications are listed in alphabetical order of "identifiers" that indicate whether the particular rate is a union rate (current union negotiated rate for local), a survey rate (weighted average rate) or a union average rate (weighted union average rate).

Union Rate Identifiers

A four letter classification abbreviation identifier enclosed in dotted lines beginning with characters other than "SU" or "UAVG" denotes that the union classification and rate were prevailing for that classification in the survey. Example: PLUM0198-005 07/01/2014. PLUM is an abbreviation identifier of the union which prevailed in the survey for this classification, which in this example would be Plumbers. 0198

indicates the local union number or district council number where applicable, i.e., Plumbers Local 0198. The next number, 005 in the example, is an internal number used in processing the wage determination. 07/01/2014 is the effective date of the most current negotiated rate, which in this example is July 1, 2014.

Union prevailing wage rates are updated to reflect all rate changes in the collective bargaining agreement (CBA) governing this classification and rate.

Survey Rate Identifiers

Classifications listed under the "SU" identifier indicate that no one rate prevailed for this classification in the survey and the published rate is derived by computing a weighted average rate based on all the rates reported in the survey for that classification. As this weighted average rate includes all rates reported in the survey, it may include both union and non-union rates. Example: SULA2012-007 5/13/2014. SU indicates the rates are survey rates based on a weighted average calculation of rates and are not majority rates. LA indicates the State of Louisiana. 2012 is the year of survey on which these classifications and rates are based. The next number, 007 in the example, is an internal number used in producing the wage determination. 5/13/2014 indicates the survey completion date for the classifications and rates under that identifier.

Survey wage rates are not updated and remain in effect until a new survey is conducted.

Union Average Rate Identifiers

Classification(s) listed under the UAVG identifier indicate

that no single majority rate prevailed for those classifications; however, 100% of the data reported for the classifications was union data. EXAMPLE: UAVG-OH-0010 08/29/2014. UAVG indicates that the rate is a weighted union average rate. OH indicates the state. The next number, 0010 in the example, is an internal number used in producing the wage determination. 08/29/2014 indicates the survey completion date for the classifications and rates under that identifier.

A UAVG rate will be updated once a year, usually in January of each year, to reflect a weighted average of the current negotiated/CBA rate of the union locals from which the rate is based.

WAGE DETERMINATION APPEALS PROCESS

1.) Has there been an initial decision in the matter? This can be:

- * an existing published wage determination
- * a survey underlying a wage determination
- * a Wage and Hour Division letter setting forth a position on a wage determination matter
- * a conformance (additional classification and rate) ruling

On survey related matters, initial contact, including requests for summaries of surveys, should be with the Wage and Hour Regional Office for the area in which the survey was conducted because those Regional Offices have responsibility for the Davis-Bacon survey program. If the response from this initial

contact is not satisfactory, then the process described in 2.) and 3.) should be followed.

With regard to any other matter not yet ripe for the formal process described here, initial contact should be with the Branch of Construction Wage Determinations. Write to:

Branch of Construction Wage Determinations
Wage and Hour Division
U.S. Department of Labor
200 Constitution Avenue, N.W.
Washington, DC 20210

2.) If the answer to the question in 1.) is yes, then an interested party (those affected by the action) can request review and reconsideration from the Wage and Hour Administrator (See 29 CFR Part 1.8 and 29 CFR Part 7). Write to:

Wage and Hour Administrator
U.S. Department of Labor
200 Constitution Avenue, N.W.
Washington, DC 20210

The request should be accompanied by a full statement of the interested party's position and by any information (wage payment data, project description, area practice material, etc.) that the requestor considers relevant to the issue.

3.) If the decision of the Administrator is not favorable, an interested party may appeal directly to the Administrative Review Board (formerly the Wage Appeals Board). Write to:

Administrative Review Board
U.S. Department of Labor

200 Constitution Avenue, N.W.
Washington, DC 20210

4.) All decisions by the Administrative Review Board are final.

END OF GENERAL DECISION

4. WEATHER RELATED DELAYS

- A. The Project Completion date shall be established with the understanding that no extension of time will be granted for weather related delays that are within the average temperature or number of rain or snow days within a particular month. The average weather conditions shall be established by referencing the records of the National Oceanic and Atmospheric Administration (NOAA) and as defined herein.
- B. Extensions of inclement weather shall be granted only when the work affected must be on schedule at the time of delay. No time will be granted for work which is behind schedule in excess of the actual delay caused by the weather, assuming the work had been on schedule.
- C. Time granted for weather delays shall be requested on a monthly basis.
- D. The weather experienced at the project site during the contract period must be found to be unusually severe, that is more severe than the adverse weather anticipated for the project location during any given month. The unusually severe weather must actually cause a delay to the completion of the project. The delay must be beyond the control and without the fault or negligence of the contractor.
- E. The anticipated adverse weather delays shall be based on the National Oceanic and Atmospheric Administration (NOAA) climatology ten year average for the Lexington Bluegrass Airport KY US location. The Mean Number of Days of daily precipitation using ≥ 0.10 will determine the base line for monthly anticipated adverse weather evaluations. The contractor's progress schedule must reflect these anticipated adverse weather delays in all weather dependent activities. Upon acknowledgement of the Notice to Proceed (NTP) and continuing throughout the contract, the contractor will record the occurrence of actual adverse weather and resultant impact to normally scheduled work. Actual adverse weather delay days must prevent work on critical path activities for 50 percent or more of the contractor's scheduled work date. The number of actual adverse weather delay days shall be calculated chronologically from the first to the last day of each month, and be recorded as full days. The number of actual adverse weather days greater than the number of anticipated adverse weather

days, listed above, shall be the number of unusually severe weather days for the purposes of any contract extensions (actual adverse weather days - anticipated adverse weather days = unusually severe weather days.)

F. Definitions:

1. "Unusually severe weather" - weather that is more severe than the adverse weather anticipated for the season or location involved.
2. "Adverse weather" - atmospheric conditions at a definite time and place that are unfavorable to construction activities.

END OF SECTION

PART VI
CONTRACT AGREEMENT

INDEX

1.	SCOPE OF WORK.....	CA-2
2.	TIME OF COMPLETION.....	CA-2
3.	ISSUANCE OF WORK ORDERS	CA-2
4.	THE CONTRACT SUM	CA-2
5.	PROGRESS PAYMENTS	CA-3
6.	ACCEPTANCE AND FINAL PAYMENT.....	CA-3
7.	THE CONTRACT DOCUMENTS.....	CA-3
8.	EXTRA WORK.....	CA-3
9.	ENUMERATION OF SPECIFICATIONS AND DRAWINGS.....	CA-4

PART VI

CONTRACT AGREEMENT

THIS AGREEMENT, made on the 26th day of April, 2018, by and between **Lexington-Fayette Urban County Government**, acting herein called "OWNER" and **Davis H Elliot Construction Company Inc**, doing business as a corporation located in the City of Lexington, County of Fayette, and State of Kentucky, hereinafter called "CONTRACTOR."

WITNESSETH: That the CONTRACTOR and the OWNER in consideration of two hundred ninety-seven thousand ninety-seven Dollars and No Cents (\$297,097.00) quoted in the proposal by the CONTRACTOR, dated February 27, 2018, hereby agree to commence and complete the construction described as follows:

1. SCOPE OF WORK

The CONTRACTOR shall furnish all the materials, supplies, machinery, equipment, tools, superintendence, labor, insurance, and other accessories and services necessary to complete the said project in accordance with the conditions and prices stated in the Proposal, the General Conditions, and the Special Conditions of the Contract, the Specifications, IonWave Q&A and Contract Documents therefore as prepared by Division of Traffic Engineering for Winchester Road, East Seventh Street, Liberty Road Intersection Improvements Project.

2. TIME OF COMPLETION

The time period estimated and authorized by the OWNER for the proper execution of the Work by the Contract, in full, is hereby fixed as one hundred eighty (180) calendar days to final completion. The time shall begin in accordance with the Notice to Proceed provided by OWNER.

3. ISSUANCE OF WORK ORDERS

Notice to begin Work will be given in whole or for part of the Work as determined by the OWNER pending the availability of funds. The order of construction will be as determined by the Engineer after consultation with the CONTRACTOR and the OWNER.

4. THE CONTRACT SUM

The OWNER agrees to pay the CONTRACTOR in current funds for the performance of the Contract, as quoted in the proposal, subject to any additions and deductions, as provided therein.

5. LIQUIDATED DAMAGES

It is mutually agreed by and between the parties hereto that time is of the essence of this Contract, and that there will be sustained by the OWNER damages, monetary and otherwise, in the event of delay in the completion of the Work hereby contracted. The CONTRACTOR will be held responsible to the OWNER for delays in completion of the Work herein contracted beyond the date set for completion. Such monetary damage shall be deducted from the Contract sum in the amount of SEVEN HUNDRED FIFTY DOLLARS (\$750.00) per calendar day of such delay. If the Work contracted to be done shall not, in good faith, be commenced at the time specified, then the CONTRACTOR together with the Surety or Sureties upon the bond herein provided for, shall be liable for and shall pay to the OWNER all damages sustained by reason of such failure for breach of Contract, and the OWNER may immediately re-let the Work involved.

6. PROGRESS PAYMENTS

The OWNER shall make payments on account of the Contract, as provided in accordance with the General Conditions, as estimated by the Engineer, less the aggregate of previous payments.

7. ACCEPTANCE AND FINAL PAYMENT

Final payment shall be due within ninety (90) days after completion of the Work, provided the Work be then fully completed and the Contract fully accepted.

Before issuance of final certificate, the CONTRACTOR shall submit evidence satisfactory to the Engineer that all payrolls, material bills, and other indebtedness connected with the Work has been paid.

If, after the Work has been substantially completed, full completion thereof is materially delayed through no fault of the CONTRACTOR, and the ENGINEER so certifies, the OWNER shall upon certificate of the ENGINEER, and without terminating the Contract, make payment of the balance due for that portion of the Work fully completed and accepted. Such payment shall be made under the terms and conditions governing final payment, except that it shall not constitute a waiver of claims.

8. THE CONTRACT DOCUMENTS

The Advertisement for Bids, Information for Bidders, the General Conditions, Performance and Payment Bonds, Contract Agreement, Special Conditions, Technical Specifications, any and all Addenda, IonWave Q&A, and Proposal, and Plan Drawings form the Contract, and they are fully a part of the Contract as if hereto attached or herein repeated.

9. EXTRA WORK

The OWNER, without invalidating the Contract, may order extra work or make changes by altering, adding to or deducting from the Work, the Contract Sum being adjusted accordingly. All such Work shall be executed and paid for in accordance with the General Conditions, which is a part of this Contract.

10. THE FOLLOWING IS AN ENUMERATION OF THE SPECIFICATIONS AND DRAWINGS (CONTRACT DOCUMENTS):

SPECIFICATIONS

SECTION NO.	TITLE	PAGES
I	Advertisement for Bids	AB 1 thru 6
II	Information for Bidders	IB 1 thru 21
III	Form of Proposal	P 1 thru 49
IV	General Conditions	GC 1 thru 52
V	Special Conditions	SC 1 thru 76
VI	Contract Agreement	CA 1 thru 5
VII	Performance and Payment Bonds	PB 1 thru 7
VIII	Addenda	AD 1 thru 1
IX	Technical Specifications	

Section A - General Provisions

Section B – Maintenance of Traffic

Section C – Final Clean up

Section 1 – Construction Staking

Section 2 – Remove Concrete and Misc Items

Section 3 – Crushed Stone

Section 4 – Monolithic Curb and Concrete Pavement

Section 5 – Geotextile Construction

Section 6 – Detectable Warning Surface Tile

Section 7 – Pavement Marking

Section 8 – Remove Signal Equipment

Section 9 – Fiber Optic Installation Kit (Novice)

Appendix A – Standard Drawings

Appendix B – KYTC Approved Traffic Management Plan

Appendix C – Local Public Agencies – Special Provisions for LPA Administered Projects

Plan Drawings

IN WITNESSETH WHEREOF, the parties hereto have executed this Contract as of the date and year above written.

(Seal)

Lexington-Fayette Urban County Government.

Lexington, Kentucky

(Owner)

ATTEST:

[Signature]
Deputy
Clerk of the Urban County Council

BY: [Signature]

MAYOR

[Signature]
(Witness)
(Seal)

(Title)

Davis H. Elliot Construction Company, Inc.

(Contractor)

[Signature]
Asst. (Secretary)* Susan Kleindl

BY: [Signature]

Reather Keith Simpson

[Signature]
(Witness) Jessica Stuart

Vice President

(Title)

673 Blue Sky Parkway Lexington, KY 40509

(Address and Zip Code)

IMPORTANT: *Strike out any non-applicable terms.

Secretary of the Owner should attest. If the CONTRACTOR is corporation, Secretary should attest. Give proper title of each person-executing Contract.

PART VII

PERFORMANCE BOND

KNOW ALL MEN BY THESE PRESENTS, that

Davis H. Elliot Construction Company, Inc.
(Name of CONTRACTOR)

673 Blue Sky Parkway, Lexington, KY 40509
(Address of CONTRACTOR)

a _____ Corporation, hereinafter
(Corporation, Partnership, or Individual)

called Principal, and Hartford Fire Insurance Company
(Name of Surety)

One Hartford Plaza , Hartford, CT 06155-0001
(Address of Surety)

hereinafter called Surety, are held and firmly bound unto

LEXINGTON-FAYETTE URBAN COUNTY GOVERNMENT
200 East Main Street, Third Floor
Lexington, Kentucky 40507

hereinafter called "OWNER" in the penal sum of: Two Hundred Ninety Seven Thousand Ninety Seven Dollars and 00/100 Dollars, (\$ 297,097.00), for the payment of whereof Principal and Surety bind themselves, their heirs, executors, administrators, successors, and assigns, jointly and severally, firmly by these presents.

WHEREAS, Principal by written agreement is entering into a Contract with OWNER for Winchester Road, East Seventh Street, Liberty Road Intersection Improvements, Bid #15-2018 - Signalization in accordance with drawings and specifications prepared by: _____ which Contract is by reference made a part hereof, and is hereinafter referred to as the Contract.

NOW THEREFORE, THE CONDITION OF THIS OBLIGATION is such that if the Principal shall promptly and faithfully perform said Contract, then this obligation shall be null and void; otherwise it shall remain in full force and effect.

The Surety hereby waives notice of any alteration or extension of time made by the OWNER.

Whenever, Principal shall be, and declared by OWNER to be in default under the Contract, the OWNER having performed OWNER'S obligations thereunder, the Surety may promptly remedy the default, or shall promptly:

- (1) Complete the Contract in accordance with its terms and conditions or
- (2) Obtain a bid or bids for completing the Contract in accordance with its terms and conditions, and upon determination by Surety of the lowest responsible bidder, or if the OWNER elects, upon determination by the OWNER and Surety jointly of the lowest responsible bidder, arrange for a Contract between such bidder and OWNER, and make available as Work progresses (even though there may be a default or a succession of defaults under the Contract or Contracts of completion arranged under this paragraph) sufficient funds to pay the cost of completion less the balance of the Contract Price; but not exceeding, including other costs and damages for which the Surety may be liable hereunder, the amount set forth in the first paragraph hereof. The term "balance of the Contract Price", as used in this paragraph shall mean the total amount payable by OWNER to Principal under the Contract and any amendments thereto, less the amount properly paid by OWNER to Principal.

Any suit under this bond must be instituted before the expiration of two (2) years from the date on which final payment under the Contract falls due.

No right of action shall accrue on this bond to or for the use of any person or corporation other than the OWNER named herein or the heirs, executors, administrators or successors of OWNER.

IN WITNESS WHEREOF, this instrument is executed in Three counterparts, each one of (number)

which shall be deemed an original, this the 26th day of April, 2018.

ATTEST:

Susan Kleindl
(Principal) Secretary SUSAN
Asst. KLEINDL

(SEAL)

Jessica Stump
(Witness to Principal) Jessica Stump

673 Blue Sky Parkway
(Address)
Lexington, KY 40509

Davis H. Elliot Construction Company, Inc.
(Principal)

BY: [Signature] (s)

673 Blue Sky Parkway
(Address)
Lexington, KY 40509

ATTEST:

Becky Huddleston
(Surety) Secretary Witness
Becky Huddleston

(SEAL)

Ashley D. Smith
Witness as to Surety Ashley D. Smith, Witness
10 Franklin Road, S.E., Suite 550
(Address)
Roanoke, VA 24011

Hartford Fire Insurance Company
(Surety)

BY: [Signature]
Theresa S. Stump (Attorney-in-Fact)

One Hartford Plaza
(Address)
Hartford, CT 06155-0001

NOTE: The number of executed counterparts of the bond shall coincide with the number of executed counterparts of the Contract.

END OF SECTION

PART VII

PAYMENT BOND

KNOW ALL MEN BY THESE PRESENT: that

Davis H. Elliot Construction Company, Inc.

(Name of Contractor)

673 Blue Sky Parkway, Lexington, KY 40509

(Address of Contractor)

a _____ Corporation, hereinafter

(Corporation, Partnership or Individual)

called Principal, and Hartford Fire Insurance Company

(Name of Surety)

One Hartford Plaza , Hartford, CT 06155-0001

(Address of Surety)

hereinafter called Surety, are held and firmly bound unto:

**LEXINGTON-FAYETTE URBAN COUNTY GOVERNMENT
200 East Main Street, Third Floor
Lexington, Kentucky 40507**

Obligee, hereinafter called OWNER, for the use and benefit of claimants as hereinafter defined, in the amount of Two Hundred Ninety Seven Thousand Ninety Seven Dollars and 00/100 Dollars (\$297,097.00) the payment whereof Principal and Surety bind themselves, their heirs, executors, administrators, successors, and assigns, jointly and severally, firmly by these presents.

WHEREAS, Principal by written agreement is entering into a Contract with OWNER for Winchester Road, East Seventh Street, Liberty Road Intersection Improvements, Bid #15-2018 - Signalization in accordance with drawings and specifications prepared by: _____ which Contract is by reference made a part hereof, and is hereinafter referred to as the Contract.

NOW, THEREFORE, THE CONDITION OF THIS OBLIGATION is such that, if Principal shall promptly make payment to all claimants as hereinafter defined for all labor and material used or reasonably required for use in the performance of the Contract, then this obligation shall be void; otherwise it shall remain in full force and effect, subject, however, to the following conditions.

1. A claimant is defined as one having a direct contract with the Principal or with a Subcontractor of the Principal for labor, material, or both, used or reasonably required for use in the performance of the Contract, labor and material being construed to include that part of water, gas, power, light, heat, oil, gasoline, telephone service or rental of equipment directly applicable to the Contract.

2. The above named Principal and Surety hereby jointly and severally agree with the OWNER that every claimant as herein defined, who has not been paid in full before the expiration of a period of ninety (90) days after the date on which the last of such claimant's work or labor was done or performed, or materials were furnished by such claimant, may sue on this bond for the use of such claimant, prosecute the suit to final judgment for such sum or sums as may be justly due claimant, and have execution thereon. The OWNER shall not be liable for the payment of any costs or expenses of any such suit.
3. No suit or action shall be commenced hereunder by any claimant:
 - (a) Unless claimant, other than one having a direct contract with the Principal, shall have given written notice to any two of the following: The Principal, the OWNER, or the Surety above named, within ninety (90) days after such claimant did or performed the last of the Work or labor, or furnished the last of the materials for which said claim is made, stating with substantial accuracy the amount claimed and the name of the party to whom the materials were furnished, or for whom the Work or labor was done or performed. Such notice shall be served by mailing the same by registered mail or certified mail, postage prepaid, in an envelope addressed to the Principal, OWNER, or Surety, at any place where an office is regularly maintained for the transaction of business, or served in any manner in which legal process may be served in the state in which the aforesaid project is located, save that such service need not be made by a public officer.
 - (b) After the expiration of one (1) year following the date on which Principal ceased Work on said Contract, it being understood, however, that if any limitation embodied in this bond is prohibited by any law controlling the construction hereof such limitation shall be deemed to be amended so as to be equal to the minimum period of limitation permitted by such law.
 - (c) Other than in a state court of competent jurisdiction in and for the county or other political subdivision of the state in which the project, or any part thereof, is situated, or in the United States District Court for the district in which the project, or any part thereof, is situated, and not elsewhere.
4. The amount of this bond shall be reduced by and to the extent of any payment or payments made in good faith hereunder, inclusive of the payment by Surety of mechanics' liens which may be filed of record against aid improvement, whether or not claim for the amount of such lien be presented under and against this bond.

IN WITNESS WHEREOF, this instrument is executed in Three each one of which shall be
(number)
deemed an original, this the 26th day of April, 2018.

ATTEST:

Susan Kleindl
(Principal) Secretary SUSAN
Asst. Kleindl

(SEAL)

Davis H. Elliot Construction Company, Inc.
(Principal)

BY: Reath Kattzi (s)

673 Blue Sky Parkway
(Address)

Lexington, KY 40509

Jessica Stuart
(Witness to Principal) Jessica Stuart

673 Blue Sky Parkway
(Address)

Lexington, KY 40509

ATTEST:

Beky Huddleston
(Surety) Secretary witness
Beky Huddleston

(SEAL)

Hartford Fire Insurance Company
(Surety)

BY: Theresa S. Stump
Theresa S. Stump (Attorney-in-Fact)

One Hartford Plaza
(Address)

Hartford, CT 06155-0001

Ashley D. Smith
Witness as to Surety Ashley D. Smith, Witness
10 Franklin Road, S.E., Suite 550

Roanoke, VA 24011
(Address)

NOTE: The number of executed counterparts of the bond shall coincide with the number of executed counterparts of the Contract.

POWER OF ATTORNEY

Direct Inquiries/Claims to:

THE HARTFORD

Bond T-12

One Hartford Plaza

Hartford, Connecticut 06155

Bond.Claims@thehartford.com

call: 888-266-3488 or fax: 860-757-5835)

Agency Code: SurePath

KNOW ALL PERSONS BY THESE PRESENTS THAT:

- Hartford Fire Insurance Company, a corporation duly organized under the laws of the State of Connecticut
- Hartford Casualty Insurance Company, a corporation duly organized under the laws of the State of Indiana
- Hartford Accident and Indemnity Company, a corporation duly organized under the laws of the State of Connecticut
- Hartford Underwriters Insurance Company, a corporation duly organized under the laws of the State of Connecticut
- Twin City Fire Insurance Company, a corporation duly organized under the laws of the State of Indiana
- Hartford Insurance Company of Illinois, a corporation duly organized under the laws of the State of Illinois
- Hartford Insurance Company of the Midwest, a corporation duly organized under the laws of the State of Indiana
- Hartford Insurance Company of the Southeast, a corporation duly organized under the laws of the State of Florida

having their home office in Hartford, Connecticut (hereinafter collectively referred to as the "Companies") do hereby make, constitute and appoint

Theresa S. Stump of Roanoke, VA

their true and lawful Attorney-in-Fact, to sign its name as surety(ies) only as delineated above by , and to execute, seal and acknowledge the following bond, undertaking, contract or written instrument:

Bond No. 14BCSHW5523 on behalf of Davis H. Elliot Construction Company, Inc. naming Lexington-Fayette Urban County Government as Obligee in the amount of See Bond Form on behalf of the Companies in their business of guaranteeing the fidelity of persons, guaranteeing the performance of contracts and executing or guaranteeing bonds and undertakings required or permitted in any actions or proceedings allowed by law.

In Witness Whereof, and as authorized by a Resolution of the Board of Directors of the Companies on May 6, 2015 the Companies have caused these presents to be signed by its Senior Vice President and its corporate seals to be hereto affixed, duly attested by its Assistant Secretary. Further, pursuant to Resolution of the Board of Directors of the Companies, the Companies hereby unambiguously affirm that they are and will be bound by any mechanically applied signatures applied to this Power of Attorney.



John Gray, Assistant Secretary

M. Ross Fisher, Senior Vice President

STATE OF CONNECTICUT }
 } ss. Hartford
COUNTY OF HARTFORD }

On this 11th day of January, 2016, before me personally came M. Ross Fisher, to me known, who being by me duly sworn, did depose and say: that he resides in the County of Hartford, State of Connecticut; that he is the Senior Vice President of the Companies, the corporations described in and which executed the above instrument; that he knows the seals of the said corporations; that the seals affixed to the said instrument are such corporate seals; that they were so affixed by authority of the Boards of Directors of said corporations and that he signed his name thereto by like authority.



CERTIFICATE

Kathleen T. Maynard
Notary Public
My Commission Expires July 31, 2021

I, the undersigned, Assistant Vice President of the Companies, DO HEREBY CERTIFY that the above and foregoing is a true and correct copy of the Power of Attorney executed by said Companies, which is still in full force effective as of April 26, 2018 Signed and sealed at the City of Hartford.

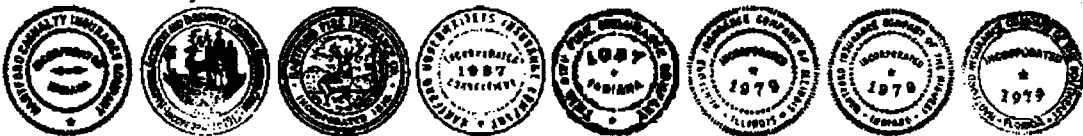

Kevin Heckman, Assistant Vice President



CERTIFICATE OF LIABILITY INSURANCE

DATE (MM/DD/YYYY)

5/8/2018

THIS CERTIFICATE IS ISSUED AS A MATTER OF INFORMATION ONLY AND CONFERS NO RIGHTS UPON THE CERTIFICATE HOLDER. THIS CERTIFICATE DOES NOT AFFIRMATIVELY OR NEGATIVELY AMEND, EXTEND OR ALTER THE COVERAGE AFFORDED BY THE POLICIES BELOW. THIS CERTIFICATE OF INSURANCE DOES NOT CONSTITUTE A CONTRACT BETWEEN THE ISSUING INSURER(S), AUTHORIZED REPRESENTATIVE OR PRODUCER, AND THE CERTIFICATE HOLDER.

IMPORTANT: If the certificate holder is an ADDITIONAL INSURED, the policy(ies) must be endorsed. If SUBROGATION IS WAIVED, subject to the terms and conditions of the policy, certain policies may require an endorsement. A statement on this certificate does not confer rights to the certificate holder in lieu of such endorsement(s).

PRODUCER Scott Insurance (Rke) 10 Franklin Road SE Ste. 550 Roanoke VA 24011	CONTACT NAME: Melanie Hackworth PHONE (A/C, No., Ext): 434-832-2295 E-MAIL ADDRESS: mhackworth@scottins.com	FAX (A/C, No): 434-455-8851
	INSURER(S) AFFORDING COVERAGE	
INSURED AEWN-2 Davis H. Elliot Co., Inc. and Its Subsidiaries P.O. Box 12108 Lexington, KY 40580	INSURER A : The Travelers Indemnity Company of America (A++) NAIC # 25666	
	INSURER B : Travelers Property Casualty Insurance Company 36161	
	INSURER C : Hanover Insurance Company (A) 22292	
	INSURER D :	
	INSURER E :	
INSURER F :		

COVERAGES

CERTIFICATE NUMBER: 784833056

REVISION NUMBER:

THIS IS TO CERTIFY THAT THE POLICIES OF INSURANCE LISTED BELOW HAVE BEEN ISSUED TO THE INSURED NAMED ABOVE FOR THE POLICY PERIOD INDICATED. NOTWITHSTANDING ANY REQUIREMENT, TERM OR CONDITION OF ANY CONTRACT OR OTHER DOCUMENT WITH RESPECT TO WHICH THIS CERTIFICATE MAY BE ISSUED OR MAY PERTAIN, THE INSURANCE AFFORDED BY THE POLICIES DESCRIBED HEREIN IS SUBJECT TO ALL THE TERMS, EXCLUSIONS AND CONDITIONS OF SUCH POLICIES. LIMITS SHOWN MAY HAVE BEEN REDUCED BY PAID CLAIMS.

INSR LTR	TYPE OF INSURANCE	ADDL INSD	SUBR WVD	POLICY NUMBER	POLICY EFF (MM/DD/YYYY)	POLICY EXP (MM/DD/YYYY)	LIMITS	
A	<input checked="" type="checkbox"/> COMMERCIAL GENERAL LIABILITY <input type="checkbox"/> CLAIMS-MADE <input checked="" type="checkbox"/> OCCUR GEN'L AGGREGATE LIMIT APPLIES PER: <input type="checkbox"/> POLICY <input checked="" type="checkbox"/> PROJECT <input type="checkbox"/> LOC OTHER:			VTC2KCO7280B24A	4/1/2018	4/1/2019	EACH OCCURRENCE	\$ 1,000,000
							DAMAGE TO RENTED PREMISES (Ea occurrence)	\$ 300,000
							MED EXP (Any one person)	\$ 10,000
							PERSONAL & ADV INJURY	\$ 1,000,000
							GENERAL AGGREGATE	\$ 2,000,000
							PRODUCTS - COMP/OP AGG	\$ 2,000,000
								\$
B	<input checked="" type="checkbox"/> AUTOMOBILE LIABILITY <input checked="" type="checkbox"/> ANY AUTO <input type="checkbox"/> ALL OWNED AUTOS <input checked="" type="checkbox"/> HIRED AUTOS <input type="checkbox"/> SCHEDULED AUTOS <input checked="" type="checkbox"/> NON-OWNED AUTOS			VTC2JCAP8181B535	4/1/2018	4/1/2019	COMBINED SINGLE LIMIT (Ea accident)	\$ 2,000,000
							BODILY INJURY (Per person)	\$
							BODILY INJURY (Per accident)	\$
							PROPERTY DAMAGE (Per accident)	\$
								\$
B	<input type="checkbox"/> UMBRELLA LIAB <input checked="" type="checkbox"/> OCCUR <input checked="" type="checkbox"/> EXCESS LIAB <input type="checkbox"/> CLAIMS-MADE DED <input checked="" type="checkbox"/> RETENTION \$ 10,000			VTSMJUCUP5787B91A	4/1/2018	4/1/2019	EACH OCCURRENCE	\$ 5,000,000
							AGGREGATE	\$
								\$
B	WORKERS COMPENSATION AND EMPLOYERS' LIABILITY ANY PROPRIETOR/PARTNER/EXECUTIVE OFFICER/MEMBER EXCLUDED? (Mandatory in NH) If yes, describe under DESCRIPTION OF OPERATIONS below Y/N <input checked="" type="checkbox"/> N / A			VTC2JUB146K0712	4/1/2018	4/1/2019	<input checked="" type="checkbox"/> PER STATUTE <input type="checkbox"/> OTH-ER	
							E.L. EACH ACCIDENT	\$ 1,000,000
							E.L. DISEASE - EA EMPLOYEE	\$ 1,000,000
							E.L. DISEASE - POLICY LIMIT	\$ 1,000,000
C	Equipment Installation Floater			RHR8662170	4/1/2018	4/1/2019	Per Item Per Jobsite	500,000 1,000,000

DESCRIPTION OF OPERATIONS / LOCATIONS / VEHICLES (ACORD 101, Additional Remarks Schedule, may be attached if more space is required)

Per policy provisions, notice of cancellation is at least 30 days except for non-payment of premium.

Workers Compensation Coverage for states AL, AR, DE, FL, GA, IL, IN, KS, KY, LA, MD, MI, MO, MS, NC, NJ, NM, NY, OK, PA, SC, TN, TX, VA, WV.

Workers Compensation policy includes Broad Form Employers Liability coverage for West Virginia.
See Attached...

CERTIFICATE HOLDER**CANCELLATION**

LFUCG
200 E. Main Street
Lexington KY 40507

SHOULD ANY OF THE ABOVE DESCRIBED POLICIES BE CANCELLED BEFORE THE EXPIRATION DATE THEREOF, NOTICE WILL BE DELIVERED IN ACCORDANCE WITH THE POLICY PROVISIONS.

AUTHORIZED REPRESENTATIVE

Kam Jones

© 1988-2014 ACORD CORPORATION. All rights reserved.



ADDITIONAL REMARKS SCHEDULE

AGENCY Scott Insurance (Rke)		NAMED INSURED Davis H. Elliot Co., Inc. and Its Subsidiaries P.O. Box 12108 Lexington, KY 40580	
POLICY NUMBER		EFFECTIVE DATE:	
CARRIER	NAIC CODE		

ADDITIONAL REMARKS

**THIS ADDITIONAL REMARKS FORM IS A SCHEDULE TO ACORD FORM,
FORM NUMBER: 25 FORM TITLE: CERTIFICATE OF LIABILITY INSURANCE**

RE: Winchester Rd, E 7th St, Liberty Rd Project

IX. TECHNICAL SPECIFICATIONS

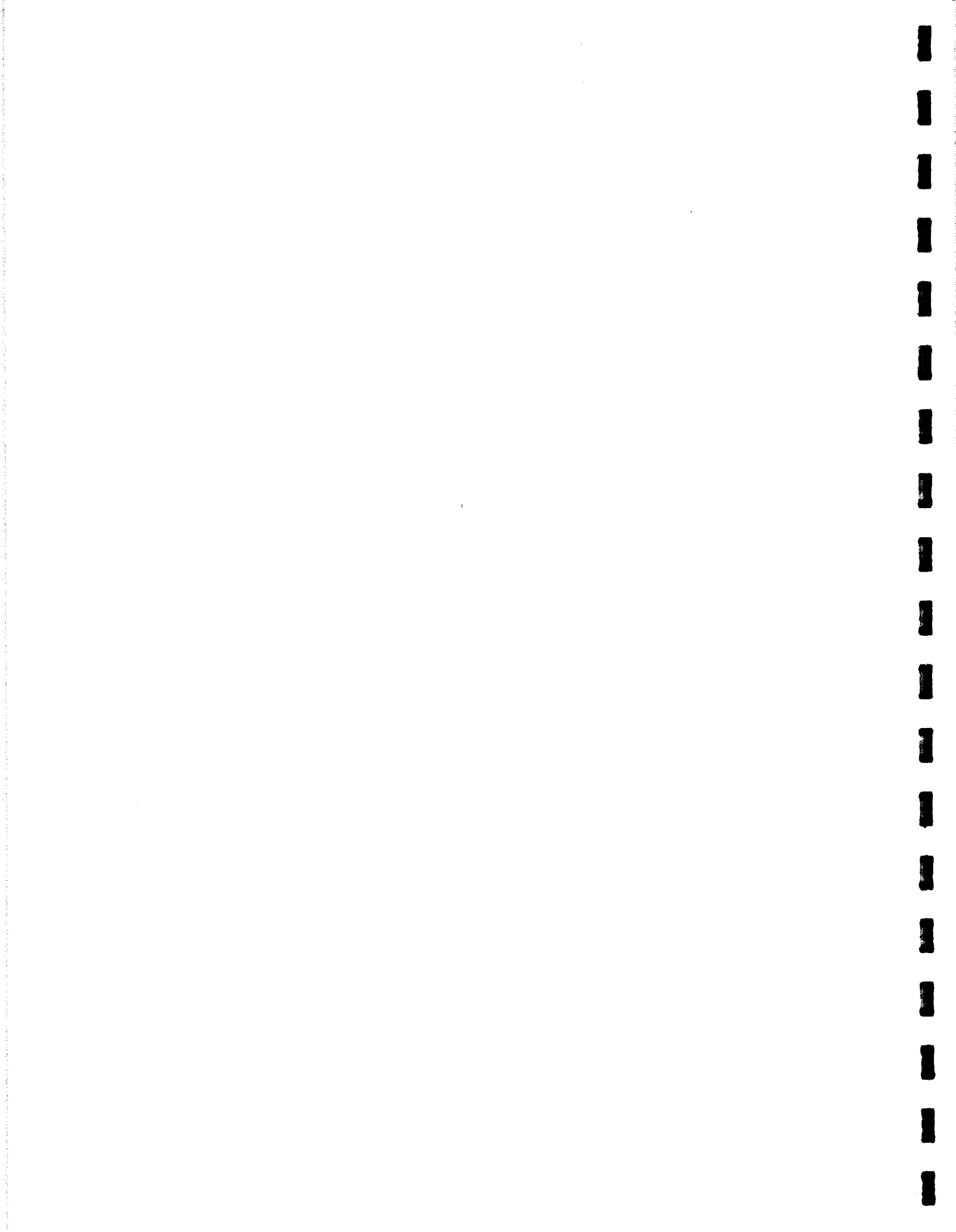

PART VIII

TECHNICAL SPECIFICATIONS

Table of Contents

SECTION A – GENERAL PROVISIONS.....	TS-2
SECTION B – MAINTENANCE OF TRAFFIC.....	TS-7
SECTION C – FINAL CLEANUP.....	TS-9
SECTION 1 – CONSTRUCTION STAKING.....	TS-10
SECTION 2 – REMOVE CONCRETE AND MISC ITEMS.....	TS-11
SECTION 3 – CRUSHED STONE.....	TS-12
SECTION 4 – MONOLITHIC CURB AND CONCRETE PAVEMENT (4 ½ INCH, 6 INCH, 12 INCH).....	TS-14
SECTION 5 – GEOTEXTILE CONSTRUCTION.....	TS-16
SECTION 6 – DETECTABLE WARNING SURFACE TILE.....	TS-17
SECTION 7 - PAVEMENT MARKING.....	TS-20
SECTION 8 - REMOVE SIGNAL EQUIPMENT.....	TS-21
SECTION 9 - FIBER OPTIC INSTALLATION KIT (NOVICE).....	TS-22

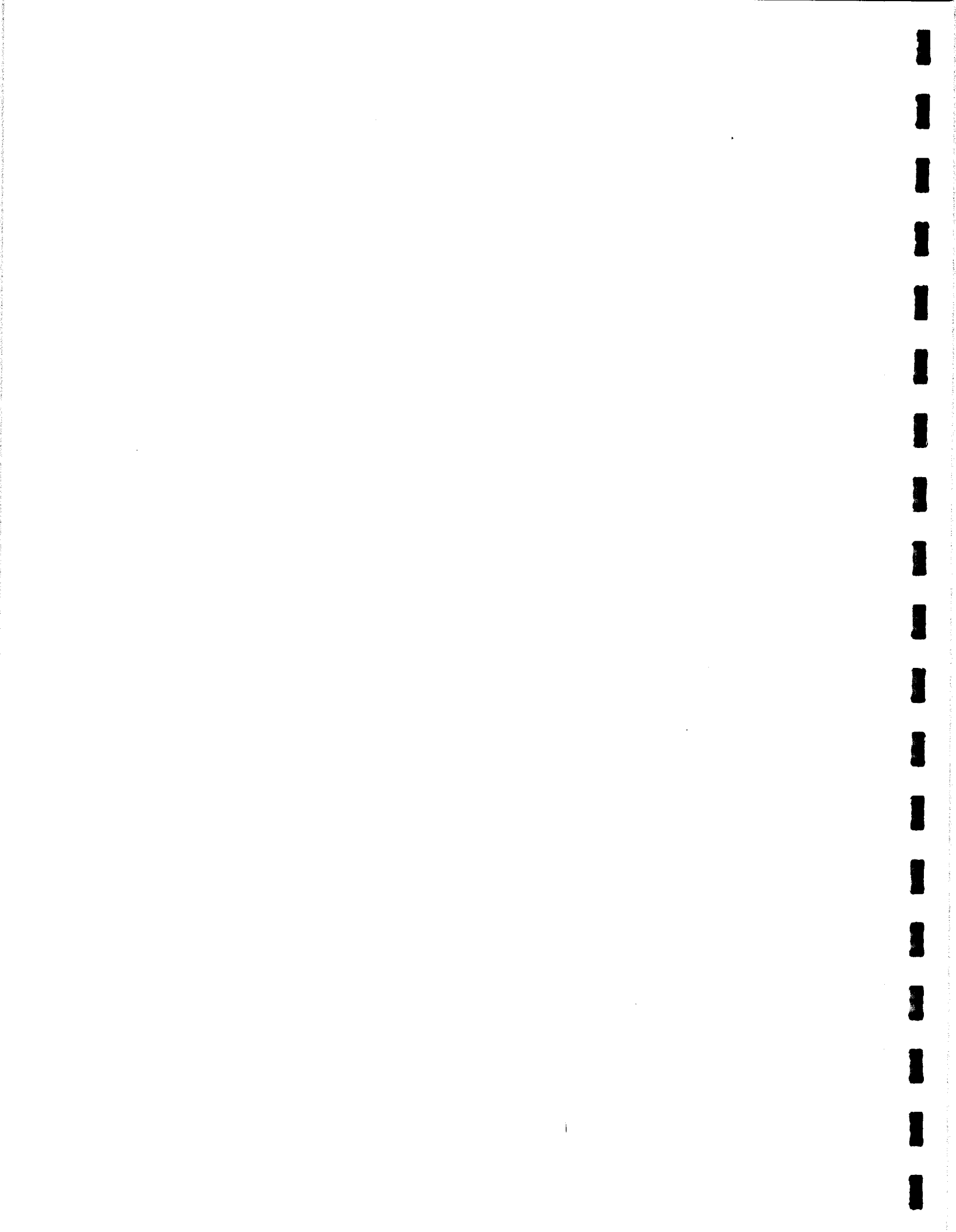

TECHNICAL SPECIFICATIONS

GENERAL PROVISIONS

A.1 KENTUCKY DEPARTMENT OF HIGHWAYS - SPECIFICATIONS

Except as otherwise indicated on the Plans, and in the Contract Documents and Specifications, all items of Work and administration of this project including materials, construction methods, method of measurement and basis of payment shall comply with the current edition of the *Kentucky Department of Highways (KDOH) Standard Specifications for Road and Bridge Construction* and all current revisions.

With regard to the incorporation *Standard Specifications of KDOH* into these Technical Specifications, the following should be noted:

- Unless either the content implicitly or the Plans and Contract Documents and Specifications explicitly indicate otherwise, all KDOH references to "the Department" should be construed as being references to the Lexington-Fayette Urban County Government (LFUCG).
- Any discrepancy between the *Standard Specifications of KDOH* and the express intentions of Lexington-Fayette Urban County Government (i.e., Plans, Contract Documents and Specifications, and Lexington-Fayette Urban County Government Standard Drawings) shall be resolved in favor of the latter. (An example of one of the more common types of discrepancy is that which sometimes occurs with regard to the measurement of and payment for Work items.)

A.2 ABBREVIATIONS

Abbreviations of standards, codes, and publications used within these Specifications are as follows:

ASTM	American Society of Testing and Materials
ANSI	American National Standard Institute
KDOH	Kentucky Department of Highways, "Standard Specifications for Road and Bridge Construction", Current Edition

A.3 SCOPE

It is the intent that the CONTRACTOR, in accordance with the Plans, Contract Documents and Specifications, and other mutually acknowledged informational materials shall perform everything required to be performed and to furnish a complete, fully operating Work, and shall provide and furnish all labor, materials, necessary tools, expendable and non-expendable equipment and all transportation services required for the entire, proper, substantial completion of the Work, the cost of all of which shall be included in his bid.

The CONTRACTOR shall make all requisite excavations and foundation preparation for constructing sidewalks, incidental drainage structures, and retaining walls. The CONTRACTOR shall, where required, excavate and prepare subgrade for pavement widening and replacement. The CONTRACTOR shall provide all signs, lighting, barricades, flagmen and watchmen, and make provisions necessary to protect and maintain buildings, fences, trees, shrubs, poles, existing utility fixtures, watercourses, surface drains, or other structures in, on, across, or adjacent to the Work and repair all damage done to them where and as required. The CONTRACTOR shall perform all backfilling, restore walks, grass plots, flowers, shrubs, trees, paved surfaces, etc., damaged or disturbed and clear away all rubbish and surplus materials. The CONTRACTOR shall put in complete and acceptable working order the items covered by the Contract.

This Specification sets forth several items of Work or conditions which are required as integral parts of the successful completion of the Project. All items discussed herein under General Provisions are considered incidental to the overall accomplishment of the Project and no separate payment shall be made therefore unless otherwise noted elsewhere in these specifications.

A.4 CONTRACTOR'S FACILITIES

A.4.1 Sanitary Facilities: The CONTRACTOR shall provide and maintain all necessary sanitary facilities at the site, in accordance with all applicable regulations, and shall properly remove same at completion of the Project.

A.4.2 Utilities: The obtaining of all utilities which may be required for construction shall be the responsibility of the CONTRACTOR.

A.5 CONTRACTOR'S FIELD OFFICE

A CONTRACTOR'S Field Office is not required for this project.

A.6 UTILITIES

The CONTRACTOR is to notify all utility companies prior to beginning construction operations.

It shall be the CONTRACTOR'S responsibility to locate all utilities, make appropriate arrangements regarding relocation, maintain utility service throughout the construction period, and make final relocations at the completion of the Work. The CONTRACTOR shall be responsible for any injury or damage to the existing utilities due to his operations whether shown or not shown in the plans. Where utilities are shown or indicated on the plans, the information given is in accordance with the best information in possession of the OWNER but is approximate only. The data is not warranted to be either complete or correct, and the CONTRACTOR shall assume all risks resulting from the conditions arising from the approximations shown.

The CONTRACTOR shall confer with the utility companies to inform them of the proposed construction schedule, verify the location and elevation of existing utilities and arrange for the

relocation and adjustment of any facilities to avoid interference with the proposed construction. All such activities are to be performed under the direction of and with the approval of the ENGINEER.

When the various utility owners find it necessary to make adjustments to their lines where the CONTRACTOR is presently working, the CONTRACTOR is to move his operations to another area of Work so as not to interfere in any way with the utility company's Work.

Any utilities covered up or lost by the construction operations of the CONTRACTOR shall be uncovered and found by the CONTRACTOR and the new construction repaired and/or replaced as directed by the ENGINEER. No additional compensation will be allowed for such Work nor shall any additional payment be allowed for the relocation and adjusting of any utility but shall be considered Incidentals to other Work.

The CONTRACTOR shall make a concerted effort to prevent any disruption of utility services, and if an unintended disruption occurs, the CONTRACTOR shall immediately and safely restore service. If disruption of any of the utility services covered in this section is unavoidable, it will be the responsibility of the CONTRACTOR to notify affected property owners. The CONTRACTOR shall also make every effort to restore said services before quitting Work for the day. In the event this cannot be done, the CONTRACTOR shall provide temporary service to the property owners until permanent service can be restored.

A.7 TESTING

CONTRACTOR shall perform slump, temperature, and concrete cylinder strength tests with the ENGINEER present and in accordance with the applicable specifications. CONTRACTOR shall create, store, test, and dispose of the concrete cylinders (three 6-inch by 12-inch) from all concrete deliveries for signal pole base construction and for the first concrete delivery for sidewalk and curb each day. No direct payment will be made for testing of concrete.

ENGINEER may require that additional testing be performed to determine the materials provided meet the specified requirements. For additional testing, the ENGINEER will select a testing laboratory to perform the testing services. The cost of additional testing shall be the responsibility of the OWNER. If testing reveals defective materials or work, the cost of said testing will become the responsibility of the CONTRACTOR.

A.7.1 Codes and Standards: Testing, when required, will be in accordance with all pertinent codes and regulations and with selected standards of the American Society for Testing and Materials.

A.7.2 Cooperation with the Testing Laboratory: Representatives of the testing laboratory shall have ready access to the Work at all times. The CONTRACTOR shall provide facilities for such access in order that the laboratory may properly perform its functions.

A.8 INSTALLATION REQUIREMENTS

Manufactured articles, materials and equipment shall be applied, installed, connected, erected, used, cleaned, and conditioned as suggested by the respective manufacturers, unless otherwise specified herein or directed by the ENGINEER.

A.9 PROOF OF COMPLIANCE

Whenever the Contract Documents require that a product be in accordance with Federal Specifications, ASTM Designations, ANSI Specifications, or other associations' standards, the CONTRACTOR shall present a certification from the manufacturer that the product complies therewith. When requested or specified, the CONTRACTOR shall submit supporting test data to substantiate compliance.

A.10 DUST CONTROL

The CONTRACTOR shall be responsible for minimizing the generation of dust resulting from his operations at all times. The CONTRACTOR shall be required to maintain all excavations, embankments, stockpiles, roads, permanent access roads, plant sites, waste areas, and all other Work areas within or without the project boundaries free from dust which would cause a hazard or nuisance to others. Approved temporary methods of stabilization consisting of sprinkling, chemical treatment, light bituminous treatment, or similar methods will be permitted to control dust. Dust control shall be performed as the Work proceeds, and whenever a dust nuisance or hazard occurs.

A.11 REPAIR OF DAMAGE

Any damage done to structures, fills, roadways, or other areas shall be repaired at the CONTRACTOR'S expense before final payment is made.

A.12 PROJECT EXTENT

The CONTRACTOR shall be responsible for satisfying himself as to the construction limits for the Project. The CONTRACTOR shall not establish Work, storage, or staging area outside the Project limits, unless otherwise directed or approved by the ENGINEER.

A.13 WORKING HOURS

All Work on this Project shall be restricted to Monday thru Saturday, but may be restricted by the ENGINEER if required; except emergency Work, such as any necessary pumping, which may require 24-hour operation. If the CONTRACTOR elects to Work beyond the normal work week, he shall notify the ENGINEER of his intent as far in advance as possible. Lane closures for all streets with a functional classification above local shall occur only between the hours of 9:00 a.m. to 3:00 p.m. and 7:00 p.m. to 6:00 a.m., except as approved by the ENGINEER.

A.14 GUARANTEE

The CONTRACTOR shall assume responsibility for all workmanship and materials for a period of one year from final payment. Any Work found to be defective due to failure to comply with the provision and intent of the Contract Documents, Specifications, and Plans shall be replaced at the CONTRACTOR'S expense.

A.15 PROPERTY CONSIDERATION

Materials having a salvage value shall remain the property of the OWNER. Salvageable material shall be delivered by the CONTRACTOR to the Division of Traffic Engineering, Operations Center, 1515 Old Frankfort Pike, Lexington, KY 40508. Salvageable material rejected by the OWNER shall become the responsibility of the CONTRACTOR to dispose of in a proper manner subject to the approval of the ENGINEER.

A.16 BLASTING

Blasting is addressed in the Special Conditions.

A.17 HAZARDOUS MATERIAL - GAS LINES

The CONTRACTOR is advised to exercise caution in his operations on this project, regardless of whether the plans indicate or do not indicate the presence of any gas or hazardous materials carrying lines.

TECHNICAL SPECIFICATIONS

SECTION B - MAINTENANCE OF TRAFFIC

B.1 SCOPE

The CONTRACTOR shall maintain all local vehicular and pedestrian traffic along the project during construction. The CONTRACTOR shall present a plan for maintenance of traffic, detours and traffic signs subject to the approval of the Lexington-Fayette Urban County Government Traffic Engineer prior to the beginning of Work. To the extent that it does not conflict with the content of the Plans, Contract Documents, and Specifications, Subsection 104.04 of KDOH Standard Specifications, current edition, is incorporated into this Technical Specification.

B.2 MATERIALS

The CONTRACTOR shall furnish bridging plates or provide other means of maintaining safe access for pedestrians and service traffic to all businesses during normal working hours. Adequate personnel shall be available during daylight hours to assure maintenance. Metal trench covers, granular backfill or other suitable methods shall be utilized to maintain vehicular traffic through areas disturbed by construction operations.

B.3 SIGNING

The CONTRACTOR shall furnish and erect suitable barricades, signs and other necessary devices to control, guide and safeguard traffic passing through or around the construction project. All such devices shall conform in all respects to the requirements of the Manual on Uniform Traffic Control Devices for Highway Construction and Maintenance Projects. The CONTRACTOR, before erecting any barricades or changing the location of one already placed, shall notify the ENGINEER at least three days prior to such contemplated erection or change, except in case of an emergency. In case of an emergency, the ENGINEER may direct the CONTRACTOR to immediately provide safety and warning devices to safeguard traffic. All night-time control devices requiring illumination shall be lighted every night during the entire period from sunset to sunrise. The CONTRACTOR will be held responsible for all damage to Work due to failure to provide barricades, signs, lights, and watchmen to protect it; and whenever evidence of such damage is found prior to acceptance, the ENGINEER may order the damaged portion removed and replaced by the CONTRACTOR at the CONTRACTOR'S expense. The responsibility remains the CONTRACTOR'S until the project is accepted. The LFUCG Road Improvement Signs shall also be included in this item.

Contractor shall designate an employee to be the Project Traffic Coordinator (PTC) and ensures that the PTC inspects the project traffic control scheme at a minimum of once per shift, reports all incidents within the work zone to the Engineer, and perform all other traffic control duties the Contract specifies.

B.4 MEASUREMENT AND PAYMENT

Accepted quantities for Maintenance of Traffic will be paid for at the Contract Unit Price as quoted (which shall be full compensation for all Work required under this section) and paid as specified. All labor, materials, and equipment shall be incidental to Maintenance of Traffic.

TECHNICAL SPECIFICATION

SECTION C - FINAL CLEANUP

C.1 SCOPE

The Work will not be considered as complete, and final payment will not be made, until the right-of-way and all ground occupied by the CONTRACTOR in connection with the Work has been cleared of all rubbish, equipment, excess materials, temporary structures, and weeds. Rubbish and all waste materials of whatever nature shall be disposed of in waste areas provided by the CONTRACTOR. All property, both public and private, which has been damaged in the execution of the Work, shall be replaced or restored in an acceptable manner. All ditches shall be drained and all space shall be left unobstructed and in such condition as acceptable to the ENGINEER.

C.2 PAYMENT

No direct payment will be made for final cleanup.

TECHNICAL SPECIFICATION

SECTION 1 - CONSTRUCTION STAKING

1.1 SCOPE

The CONTRACTOR shall furnish and be responsible for all staking (including initial staking), necessary to control and complete the Work per the specifications and in accordance with the lines and grades shown on the plans,

It will be the OWNER'S responsibility to make all measurements for determining final quantities to be used for basis of final payment on items of Work.

To the extent that it does not conflict with the content of the Plans and Contract Documents and Specifications, Section 201 of KDOH Standard Specifications, current edition, is incorporated into this technical specification.

1.2 PAYMENT

No payment will be made for Construction Staking.

TECHNICAL SPECIFICATION

SECTION 2 – REMOVE CONCRETE AND MISC ITEMS

(REMOVE PORTLAND CEMENT CONCRETE PAVEMENT, SIDEWALKS, ENTRANCE PAVEMENT, BITUMINOUS CONCRETE PAVEMENT, AND CURB)

2.1 SCOPE

Work will consist of the removal of existing sidewalks. Work for this Section shall conform to the Kentucky Department of Highways Standard Specifications, Section 203, current edition and shall include all labor, materials (including base and DGA), equipment, excavation, disposal, sawcutting and incidentals necessary to complete Work. Removal areas will terminate at fully sawed joint faces.

Contractor will be required to restore adjacent pavement to remain damaged by construction. Restoration to include asphalt surfacing milling and asphalt surface installation to a depth of 1.25 inches. The milling width shall be at a minimum the entire width of the adjacent lane (bike lane or travel lane).

2.2 BASIS OF PAYMENT FOR THE REMOVAL OF CONCRETE SIDEWALK

Accepted quantities for Removal of Concrete Sidewalk, Entrance Pavement, and Bituminous Concrete Pavement will be paid for at the Contract Unit Price as quoted for each item (which shall be full compensation for all Work under this Section) and paid per square yard of the specified item satisfactorily removed. All labor, materials (including base and DGA), excavation, and equipment shall be incidental to the removal of Portland Cement Concrete Pavement, Sidewalk, Entrance Pavement, and Bituminous Concrete Pavement.

TECHNICAL SPECIFICATIONS

SECTION 3 - CRUSHED STONE

3.1 SCOPE

All Work for this Section shall consist of furnishing and placing commercially available Crushed Stone aggregate in sizes and locations as determined by the ENGINEER and shall include all labor, materials, equipment, excavation, compaction, and incidentals necessary to complete the Work in place, ready for use and constructed in conformance with KDOH Standard Specifications.

No. 2's meeting the requirements of KDOH Section 805 should be used for locations as determined by the Engineer and shall include all labor, materials, equipment, excavation, and incidentals necessary to complete the Work in place, ready for use and constructed in conformance with KDOH Standard Specifications. No. 2 Stone meeting the requirements of KDOH Section 805 can be used for stabilizing sub-grade and pavement base etc.

Where soft, undesirable soil material is encountered at or below desired sub-grade elevation, undesirable material will be removed and/or bridged to develop a sufficient platform to support compaction of DGA. The depth and extent of this work shall be determined based on conditions observed and performance of compaction equipment on the sub-grade. Work shall be directed by the Engineer.

Stone will be dumped or pushed into place and walked in until support is developed for heavy equipment. The ultimate test will be the ability to provide an adequate compaction platform for the DGA base.

No. 9's and No. 57's meeting the requirements of KDOH Section 805 should be used for stabilizing subgrade and pavement base, trench backfill, in areas of undercut, as backfill in areas of pavement restoration, or pipe bedding not incidental to pipe as a pay item.

3.2 PAYMENT

Accepted quantities for No. 2's will be paid for at the respective Contract Unit Price as quoted (which shall be full compensation for all Work required under this Section) and paid per ton of stone. No direct measurement shall be made. Payment shall be based on weight tickets for stone delivered and accepted for the work. All labor, materials (other than No. 2 Stone), equipment, proof testing, excavation and disposal of excavated material shall be incidental to the placement of No. 2 Stone.

Accepted quantities for No. 9's and No. 57's will be paid for at the respective Contract Unit Price as quoted (which shall be full compensation for all Work required under this Section) and paid per ton of Crushed Stone satisfactorily placed. Payment shall be based on weight

tickets for stone delivered and accepted for work. All labor, materials (other than the Crushed Stone), equipment, and excavation shall be incidental to the placement of Crushed Stone.

TECHNICAL SPECIFICATIONS

SECTION 4 - MONOLITHIC CURB AND CONCRETE PAVEMENT (4½ INCH, 6 INCH AND 12 INCH)

4.1 SCOPE

This Work consists of the construction of monolithic curb and concrete pavement for sidewalks, ramps, and entrances on a thoroughly compacted subgrade in accordance with the Plans, Contract Documents and Specifications, and Lexington-Fayette Urban County Government (LFUCG) Standard Drawings, current edition. Work in this section shall also conform to Sections 206, 207, 505, 601, 801, 802, 803, 804, 805, and 823 of the Kentucky Department of Highways (KDOH) Standard Specifications, current edition, but only to the extent that these KDOH sections do not conflict with the content of the Plans, Contract Documents and Specifications, and LFUCG Standard Drawings.

Concrete pavement within the neat lines of an entrance shall be considered part of the entrance with regard to construction requirements and also measurement and payment. The entire entrance shall be completed in continuous pour unless means of ingress and egress from the property is not able to be maintained by alternative means or if approved otherwise by the ENGINEER.

Subgrade shall be thoroughly compacted. Soft or unsuitable subgrade shall be excavated and replaced with compacted No. 57 stone. At the discretion of the Engineer, Contractor shall place a 4" thick subbase of No. 57 stone on top of compacted subgrade and shall strike and mechanically compact the stone to produce a uniform flat surface.

Expansion joints shall be placed at 32-foot intervals. Expansion joint material shall be of approved quality and of one-half (½) inch thickness. Expansion joints shall extend entirely and continuously through the concrete, and all excess expansion joint material shall be trimmed to conform to the surface of the concrete.

Concrete shall be sufficiently vibrated to assure removal of air voids. Concrete sidewalks shall be struck off by use of a screed, and they shall be floated and brushed. Edges and division marks shall be finished in a neat and workmanlike manner through use of the proper concrete finishing tools. Division joints in sidewalks shall be three-fourths (¾) inch in depth, at four foot intervals, or as indicated on the Plans.

When it is necessary to replace portions of existing concrete sidewalks and entrance pavements, such existing features will be removed to the nearest transverse joint or division mark beyond the matching point indicated on the Plans. The existing concrete shall be sawed by an approved concrete saw. In the absence of a transverse joint or division mark, the sawing shall be performed as directed by the ENGINEER. It will not be permissible to place new concrete

against the ragged edges of concrete caused by removal devices such as hand tools and air hammers.

All concrete used shall be Class A concrete on which Type 2 (white pigmented) curing compound is used (clear curing compound will be required in Historic Districts). Any placing of concrete must be immediately preceded by inspection and approval of the ENGINEER.

Work for this section shall include all labor, materials, equipment, excavation, and incidentals necessary to complete the Work.

4.2 PAYMENT

Accepted quantities for Monolithic Curb and Concrete Pavement - 4 ½ inch, 6 inch, and 12 inch shall be paid for at their respective Contract Unit Prices as quoted (which shall be full compensation for all Work required under this Section) and paid per square yard of specified concrete pavement satisfactorily placed. All labor, materials, equipment, subgrade compaction, excavation and backfill shall be incidental to the placement of Monolithic Curb and Concrete Pavement - 4 ½ inch, 6 inch, 12 inch..

Accepted quantities for No. 57's will be paid for at the respective Contract Unit Price as quoted (which shall be full compensation for all Work required under this Section) and paid per ton of Crushed Stone satisfactorily placed, leveled and compacted. Payment shall be based on weight tickets for stone delivered and accepted for work. All labor, materials (other than the Crushed Stone), equipment, and excavation shall be incidental to the placement of Crushed Stone.

Accepted quantities for No. 2's will be paid for at the respective Contract Unit Price as quoted (which shall be full compensation for all Work required under this Section) and paid per ton of stone. No direct measurement shall be made. Payment shall be based on weight tickets for stone delivered and accepted for the work. All labor, materials (other than No. 2 Stone), equipment, proof testing, excavation and disposal of excavated material shall be incidental to the placement of No. 2 Stone.

TECHNICAL SPECIFICATIONS

SECTION 5 - GEOTEXTILE CONSTRUCTION

5.1 SCOPE

Work for this Section shall be in accordance to Kentucky Department of Highways Standard Specifications Sections 214 and 843 (Type III for subgrade or embankment foundation stabilization), current edition and shall include all labor, grading, materials, equipment, and incidentals necessary to complete the work.

5.2 BASIS OF PAYMENT

Accepted quantities for Geotextile Construction will be paid for at the Contract Unit Price per various types as quoted which shall be full compensation for all Work required under this Section and paid per square yard of geotextiles satisfactorily placed. All labor, materials (other than the geotextile fabric), equipment, and grading shall be incidental to the placement of geotextile fabric (Type I, Type II, Type III or Type IV).

TECHNICAL SPECIFICATIONS

SECTION 6- DETECTABLE WARNING SURFACE TILE

6.1 SCOPE OF WORK

This Section specifies the type and installation of the Detectable Warning Surface Tiles where indicated and is concurrent with the installation of concrete sidewalk ramps. Tiles shall be Access Tile (Tactile System) Cast in Place Replaceable Tile manufactured by Access Products, Inc. (241 Main Street Suite 100 – Buffalo, NY 14203, Tel: 888-679-4022, Fax: 877-679-4022, email for Tech Support: tech@accessproducts.com), or Composite Wet Set Replaceable Tactile Warning Surface Unit manufactured by ADA Solutions, Inc. (P.O. Box 3 North Billerica, MA 01862, Tel: 800-372-0519, www.adatile.com), or approval equal.

6.2 SITE CONDITIONS

Environmental Conditions and Protection: Maintain minimum temperature of 40°F in spaces to receive tactile tiles for at least 48 hours prior to installations, during installation, and for not less than 48 hours after installation. Tiles shall be within +/- 10% of ambient temperature when placed. Subsequently, maintain minimum temperature of 40°F in areas where work is completed. The use of water for work, cleaning or dust control, etc. shall be contained and controlled and shall not be allowed to come into contact with nearby structures, fixtures, motor vehicles, pedestrians, etc. Provide barricades or screens to protect passengers or public. Disposal of any potentially hazardous liquids or other materials shall be made in accordance with federal state and local laws and ordinances. Cleaning materials shall have code acceptable low VOC solvent content and low flammability if used on the site.

6.4 INSTALLATION

Installation shall be performed as to the manufacturers Installation Guidelines and Procedures. See manufacturer's instructions for installation.

6.5 BASIS OF PAYMENT

Accepted quantities under this section shall be paid for at the unit bid price per square foot for the appropriate size of Detectable Warning Surface Tile installed. Payment shall be considered full compensation for all materials and labor required to complete the work described in this section.

6.6 QUALITY ASSURANCE

- A. Provide Detectable warning surface tiles and accessories as produced by a single manufacturer.

- B. **Installer's Qualifications:** Engage an experienced installer certified in writing by Detectable warning surface tile manufacturer as qualified for installation, who has successfully completed installations similar in material, design, and extent to that indicated for project.
- C. **Americans with Disabilities Act (ADA):** Provide Detectable warning surface tile which comply with the detectable warnings on walking surfaces section of the Americans with Disabilities Act (Title III Regulations, 28 CFR Part 36 ADA STANDARDS FOR ACCESSIBLE DESIGN, Appendix A, Section 4.29.2 DETECTABLE WARNINGS ON WALKING SURFACES).

6.7 DELIVERY, STORAGE AND HANDLING

- A. Detectable warning surface tile shall be suitably packaged or crated to prevent damage in shipment or handling. Finished surfaces shall be protected by sturdy plastic wrappings to protect tile from concrete residue during installation and tile type shall be identified by part number.
- B. Detectable warning surface tiles shall be delivered to location at project site for storage prior to installation.

6.8 CLEANING AND PROTECTING

- A. Protect tiles against damage during construction period to comply with tactile tile manufacturer's specification.
- B. Protect tiles against damage from rolling loads following installation by covering with plywood or hardwood.
- C. Clean tactile tiles not more than four days prior to date scheduled for inspection intended to establish date of substantial completion in each area of project. Clean tactile tile by method specified by tactile tile manufacturer.

6.9 SITE CONDITIONS

- A. **Environmental Conditions and Protection:** Maintain minimum temperature of 40°F in spaces to receive Detectable warning surface tiles for at least 24 hours prior to installation, during installation, and for not less than 24 hours after installation.
- B. The use of water for work, cleaning or dust control, etc. shall be contained and controlled and shall not be allowed to come into contact with the general public. Provide barricades or screens to protect the general public.

6.10 WARRANTY

Detectable warning surface tiles shall be warranted in writing for a period of five (5) years from date of final completion. The guarantee includes defective work, breakage, deformation, fading and loosening of tiles.

TECHNICAL SPECIFICATIONS

SECTION 7 – PAVEMENT MARKING

7.1 SCOPE

This Work shall consist of the furnishing and installation of durable marking materials and removal of existing marking removal in accordance with the Plans, Contract Documents, and Specifications. Work in this section shall also conform to the Kentucky Department of Highways (KDOH) Standard Specifications, Section 714, of the current edition and associated cross references, but only to the extent that these KDOH sections do not conflict with the content of the Plans, Contract Documents and Specifications.

7.2 BASIS OF PAYMENT

Accepted quantities for Crosswalk, Thermoplastic 12-Inch White and Stop Bar, Thermoplastic 24-Inch White will be paid for at the Contract Unit Price quoted (which shall be full compensation for all Work required under this Section) and paid per linear foot, satisfactorily placed.

Payment for Pavement Striping Removal shall be paid for as a lump sum and shall include all labor, equipment, and materials necessary to complete this work.

TECHNICAL SPECIFICATIONS

SECTION 8 – REMOVE SIGNAL EQUIPMENT

8.1 SCOPE

This Work shall consist of the removal of existing signal equipment in accordance with the Plans, Contract Documents, and Specifications. Work in this section shall also conform to the Kentucky Department of Highways (KDOH) Standard Specifications, Section 723, of the current edition and associated cross references, but only to the extent that these KYTC sections do not conflict with the content of the Plans, Contract Documents and Specifications.

8.2 BASIS OF PAYMENT

Contrary to Kentucky Department of Highways (KDOH) Standard Specifications 723.04.22 Remove Signal Equipment. The quantity for removal shall be bid as lump sum which and include removal of all poles, signal equipment, pedestrian signals, wiring, beams, cabinet, etc. and incidentals necessary to install the new signals, poles, mast arms and pedestrian equipment.

Payment for Remove Signal Equipment shall be paid for as a lump sum and shall include all labor, equipment, and materials necessary to complete this work.

TECHNICAL SPECIFICATIONS

SECTION 9 – FIBER OPTIC INSTALLATION KIT (NOVICE)

9.1 SCOPE

This Work shall consist of providing and installing Fiber Optic Installation Kit (Novice). Each kit shall have all items listed shipped in one box and delivered to the LFUCG Division of Traffic Engineering Operations Center for inspection prior to installation. Each kit shall contain the following:

- One (1) indoor/outdoor 6-fiber single-mode cable, ST connector to pigtail, 100-meter/1 meter breakout
- One (1) Velcro wrap, Black, (1"x8") w/screw mount cut out
- Two (2) Duplex ST to ST 3-meter, SM jumper
- One (1) Wall Mount Enclosure Single Panel Housing
- One (1) 6-port panel T SM loaded

9.2 BASIS OF PAYMENT

Payment for Fiber Optic Installation Kit (Novice) shall be paid for as a lump sum and shall include all labor, equipment, and materials necessary to complete this work.

PART IX

ADDENDA

Addendum
Number

Title

Date

1.

2.

3.

4.

5.

Appendix A
Standard Drawings

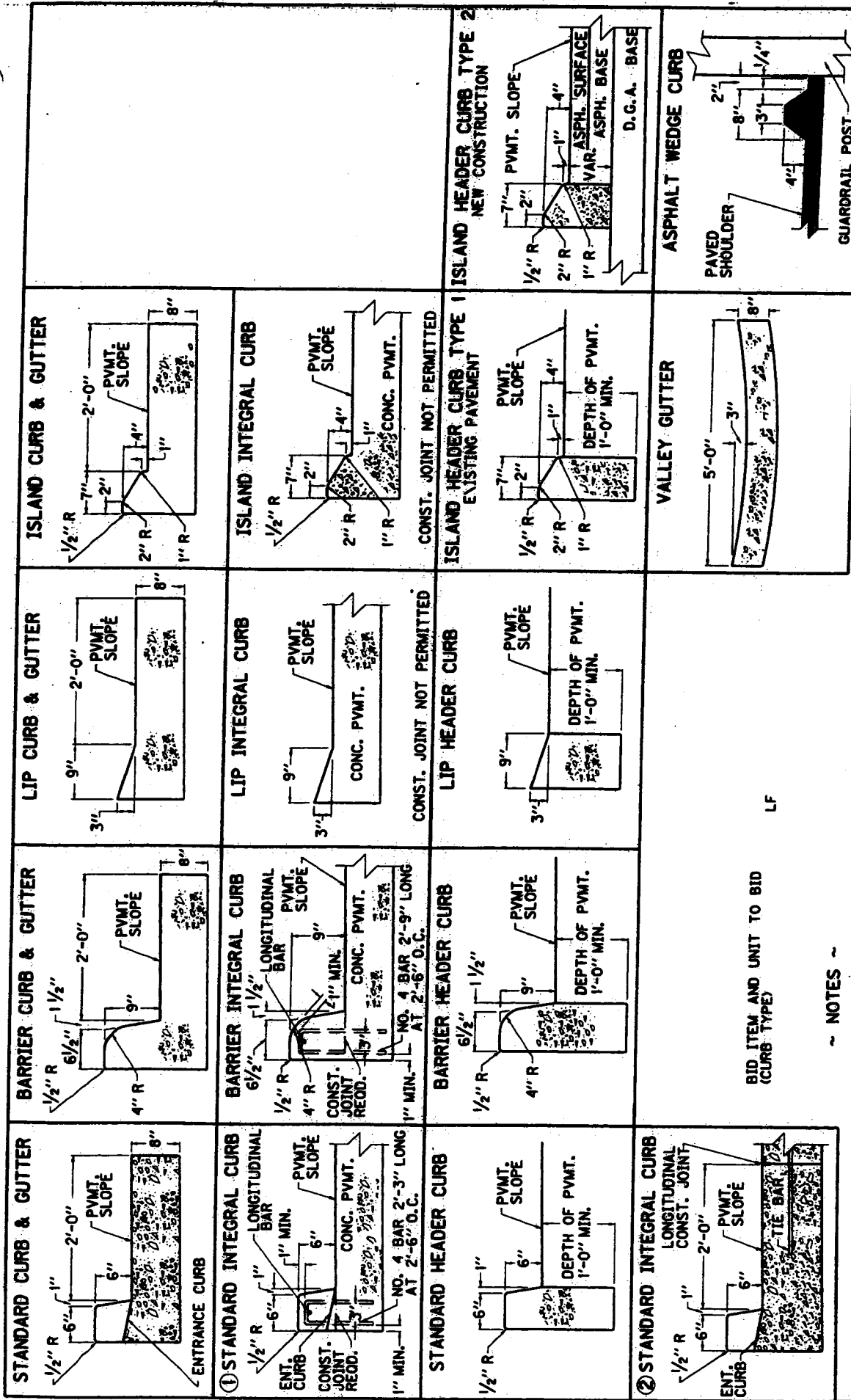

~ NOTES ~

- ALL INTEGRAL CURBS SHOWING REINFORCING STEEL SHALL BE CAST SEPARATELY FROM THE PAVEMENT AND THE REINFORCEMENT SHALL CONSIST SOLELY OF NO. 4 BARS AS DETAILED ON THIS DRAWING. ON CONSTRUCTION CARE SHOULD BE TAKEN SO THAT NO REINFORCEMENT BARS ARE CLOSER THAN 3" TO THE CENTER OF THE SAWED TRANSVERSE JOINT.
- THE CONTRACTOR HAS THE OPTION OF CONSTRUCTING THE STANDARD INTEGRAL CURB AS DETAILED IN EITHER (1) OR (2). IF (2) IS CHOSEN A LONGITUDINAL CONSTRUCTION JOINT SHALL BE REQUIRED AND THE REMAINING PAVEMENT AND CURB SHALL BE CONSTRUCTED MONOLITHIC WITHOUT A HORIZONTAL CONSTRUCTION JOINT AND ACCOMPANYING REINFORCING STEEL.

EXP. JOINT REQUIRED WHEN ABUTTING ANOTHER RIGID STRUCTURE

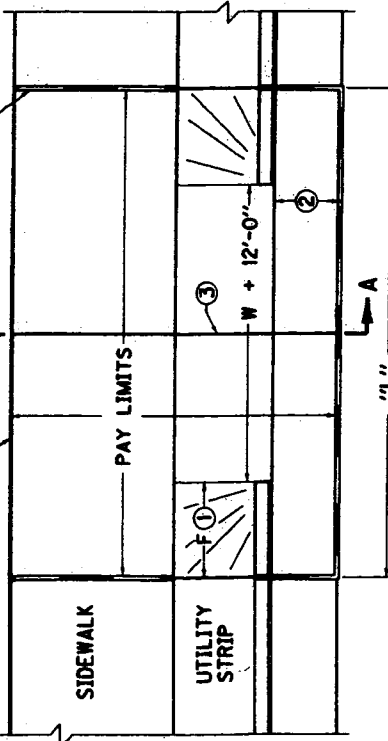

PLAN VIEW

NOTES -

- ① FOR WIDTH "W" AND "F"
RESIDENTIAL - MINIMUM W = 12'-0", MAXIMUM W = 24'-0"; MINIMUM F = 2'-6", MAXIMUM F = 10'-0"
COMMERCIAL - MINIMUM W = 24'-0", MAXIMUM W = 36'-0"; MINIMUM F = 10'-0", MAXIMUM F = 10'-0"
WHEN MORE THAN TWO LANES ARE REQUIRED, 36'-0" WIDTH MAY BE INCREASED TO RELIEVE INTERFERENCE BETWEEN ENTERING AND EXITING TRAFFIC. AT THE ENGINEER'S DISCRETION RADIAL RETURNS MAY BE USED ON ENTRANCES. SOME APPLICABLE CASES ARE THE FOLLOWING:
a. ON ENTRANCES EXPECTED TO CARRY HIGH VOLUMES OF TRAFFIC.
b. WHEN ENTRANCE WIDTH IS GREATER THAN 36'.
c. WHEN THE HIGHWAY HAS A POSTED OR OPERATING SPEED OVER 40 MPH.
d. ON A RURAL SECTION WHERE A FLUSH SHOULDER EXISTS.
e. WHERE AN EXCLUSIVE RIGHT TURN LANE IS USED.
- ② 1'-0" OR 2'-0" WITH CONCRETE PAVEMENT, 2'-0" WITH FLEXIBLE PAVEMENT
- ③ WHEN "L" DIMENSION IS GREATER THAN 15'-0" A SAWED AND SEALED JOINT, 1/2" DEEP AND 1/4" WIDE SHALL BE PLACED AT THE CENTER OF THE "L" DIMENSION. WIDE ENTRANCES REQUIRE ADDITIONAL JOINTS. SPACING SHALL NOT EXCEED 15'-0" O.C.
- ④ CLASS "A" CONCRETE OR JOINTED PLAIN CONCRETE PAVEMENT SHALL BE USED IN THE ENTRANCE PAVEMENT.
- ⑤ THE ENTRANCE PAVEMENT SHALL RECEIVE A BROOM FINISH AND SHALL BE CURED THE SAME AS THE MAINLINE PAVEMENT AND/OR SIDEWALK.
- ⑥ THE CONTRACT UNIT PRICE BID PER SQUARE YARD FOR "CEM CONC ENT PAVEMENT-8 IN" SHALL INCLUDE CLASS "A" CONCRETE AND ALL INCIDENTALS NECESSARY TO COMPLETE THE WORK. D.G.A. AND DETECTABLE WARNINGS ARE SEPARATE BID ITEMS.
- ⑦ USE CONDITION NO. 2 OR NO. 3 WHEN LITTLE OR NO UTILITY STRIP IS PROVIDED, AND INCORPORATE FEATURES OF OTHER DESIGNS SHOWN WHERE NOT IN CONFLICT.
- ⑧ PROVIDED THAT ADA GUIDELINES SHOWN IN NOTES ⑨ AND ⑩ ARE FOLLOWED, THE ENGINEER MAY MODIFY THE DESIGN TO BETTER FIT EXISTING CONDITIONS.
- ⑨ 2% CROSS SLOPE MAXIMUM ON SIDEWALK. IF CONDITIONS WARRANT, SIDEWALK MAY BE SLOPED 2% AWAY FROM ROADWAY.
- ⑩ SIDEWALKS SHOULD BE DESIGNED WITH A MAX. GRADE OF 5% WHERE A SIDEWALK RUNS ALONG A STEEP ROADWAY. THE SIDEWALK GRADE MAY EXCEED 5% IF IT FOLLOWS THE GRADE OF THE ROADWAY. WHERE THE GRADE EXCEEDS 5%, A LEVEL LANDING SHALL BE REQUIRED EVERY 200'.
- ⑪ COMMERCIAL DRIVEWAYS WITH TRAFFIC CONTROL DEVICES REQUIRE ADA SIDEWALK TREATMENTS WITH DETECTABLE WARNINGS.
BID ITEMS AND UNIT TO BID
CEM CONC ENT PAVEMENT-8 IN
DGA BASE
DETECTABLE WARNINGS

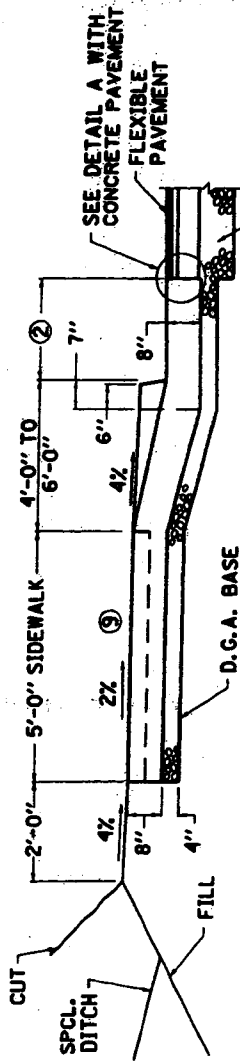

SECTION A-A CONDITION NO. 1

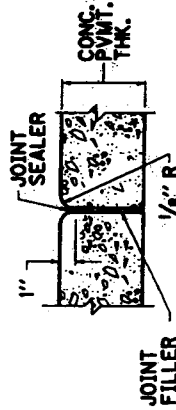

DETAIL A

CONDITION NO. 3

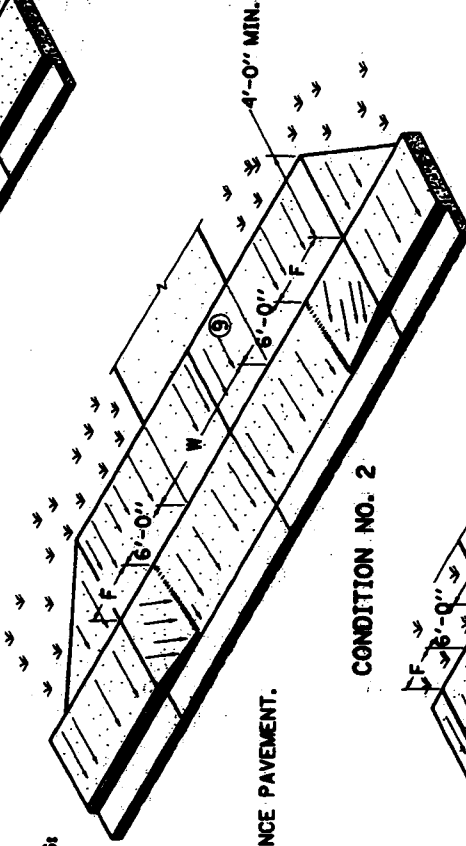

CONDITION NO. 2

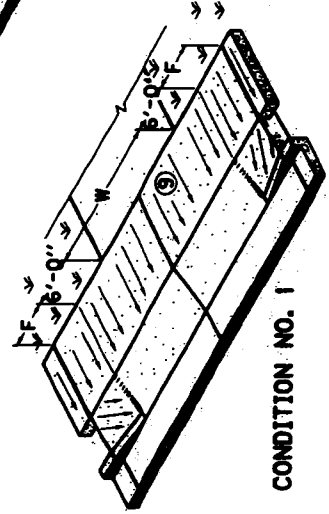

CONDITION NO. 1

USE WITH CUR. STD. DWG.
RCX-040

KENTUCKY
DEPARTMENT OF HIGHWAYS
CONCRETE
ENTRANCE PAVEMENT
AND SIDEWALK
STANDARD DRAWING NO. RPM-150-08
12-01-18
12-01-18

SOYD
TON
SOFT

EXP. JOINT REQUIRED WHEN ABUTTING ANOTHER RIGID STRUCTURE

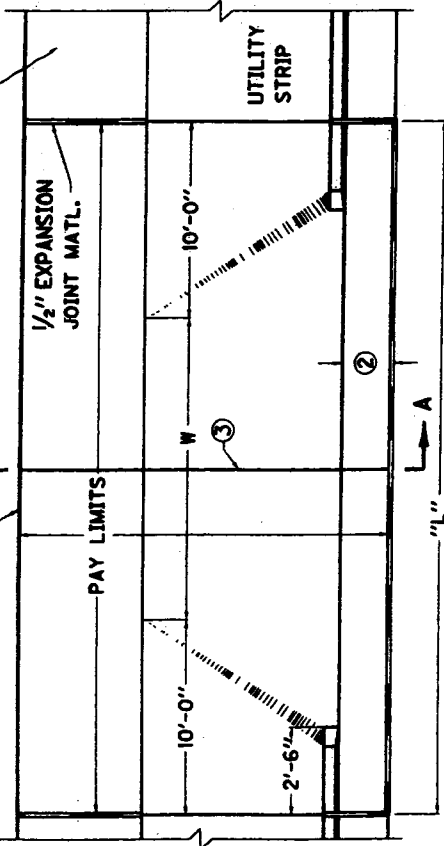

PLAN VIEW

NOTES

1. BID ITEMS AND UNIT TO-BID CEM CONC ENT PAVEMENT-8 IN DGA BASE DETECTABLE WARNINGS FOR WIDTH "W", COMMERCIAL - MINIMUM W = 24'-0", MAXIMUM W = 36'-0" WHEN MORE THAN TWO LANES ARE REQUIRED, 36' WIDTH MAY BE INCREASED TO RELIEVE INTERFERENCE BETWEEN ENTERING AND EXITING TRAFFIC, AT THE ENGINEER'S DISCRETION RADIAL RETURNS MAY BE USED ON ENTRANCES. SOME APPLICABLE CASES ARE THE FOLLOWING:
 - a. ON ENTRANCES EXPECTED TO CARRY HIGH VOLUMES OF TRAFFIC.
 - b. WHEN ENTRANCE WIDTH IS GREATER THAN 36'.
 - c. WHEN THE HIGHWAY HAS A POSTED OR OPERATING SPEED OVER 40 MPH.
 - d. ON A RURAL SECTION WHERE A FLUSH SHOULDER EXISTS.
 - e. WHERE AN EXCLUSIVE RIGHT TURN LANE IS USED.
2. 1'-0" OR 2'-0" WITH CONCRETE PAVEMENT, 2'-0" WITH FLEXIBLE PAVEMENT.
3. WHEN "L" DIMENSION IS GREATER THAN 15'-0" A SAWED AND SEALED JOINT, 1/2" DEEP AND 1/2" WIDE SHALL BE PLACED AT THE CENTER OF THE "L" DIMENSION, WIDE ENTRANCES REQUIRE ADDITIONAL JOINTS, SPACING SHALL NOT EXCEED 15'-0" O.C.
4. CLASS "A" CONCRETE OR JOINTED PLAIN CONCRETE PAVEMENT SHALL BE USED IN THE ENTRANCE PAVEMENT.
5. THE ENTRANCE PAVEMENT SHALL RECEIVE A BROOM FINISH AND SHALL BE CURED THE SAME AS THE MAINLINE PAVEMENT AND/OR SIDEWALK.
6. THE CONTRACT UNIT PRICE BID PER SQUARE YARD FOR "CEM CONC ENT PAVEMENT-8 IN" SHALL INCLUDE CLASS "A" CONCRETE AND ALL INCIDENTALS NECESSARY TO COMPLETE THE WORK. D.G.A. AND DETECTABLE WARNINGS ARE SEPARATE BID ITEMS.
7. PROVIDING THAT ADA GUIDELINES SHOWN IN NOTE 8 AND 9 ARE FOLLOWED, THE ENGINEER MAY MODIFY THE DESIGN TO BETTER FIT EXISTING CONDITIONS.
8. 2% CROSS SLOPE MAXIMUM ON SIDEWALK.
9. SIDEWALKS SHOULD BE DESIGNED WITH A MAX. GRADE OF 5% WHERE A SIDEWALK RUNS ALONG A STEEP ROADWAY. THE SIDEWALK GRADE MAY EXCEED 5% IF IT FOLLOWS THE GRADE OF THE ROADWAY.
10. COMMERCIAL DRIVEWAYS WITH TRAFFIC CONTROL DEVICES REQUIRE ADA SIDEWALK TREATMENTS WITH DETECTABLE WARNINGS.

SOYO
TON
SOFT

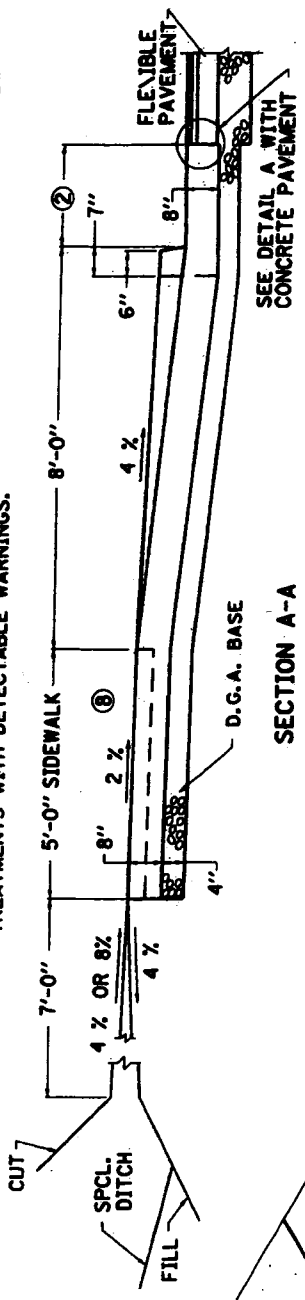

SECTION A-A

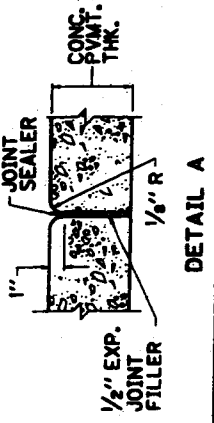
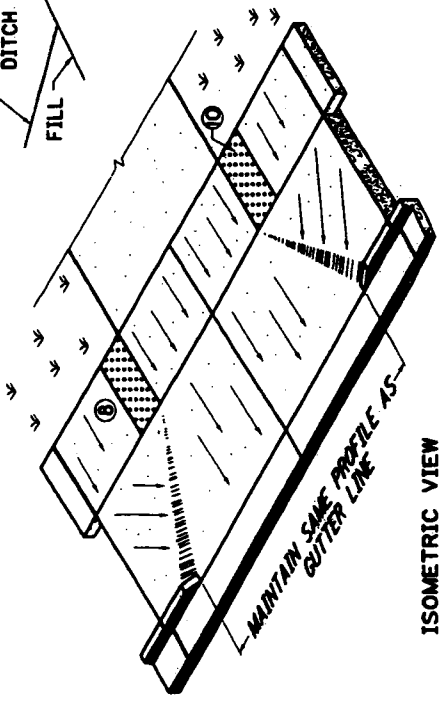

DETAIL A

USE WITH CUR. STD. DWG.
RG1-040

KENTUCKY
DEPARTMENT OF HIGHWAYS

CONCRETE
ENTRANCE PAVEMENT
AND SIDEWALK

STANDARD DRAWING NO. RFP-MF152-08
SUBMITTED: 12-01-15
APPROVED: 12-01-15

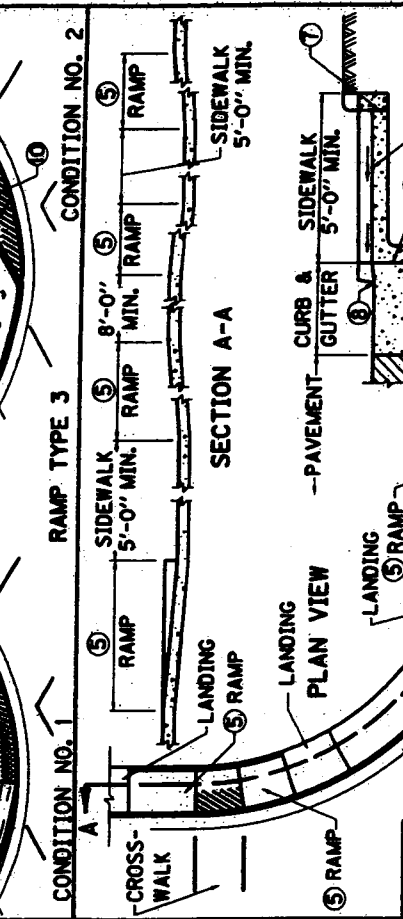
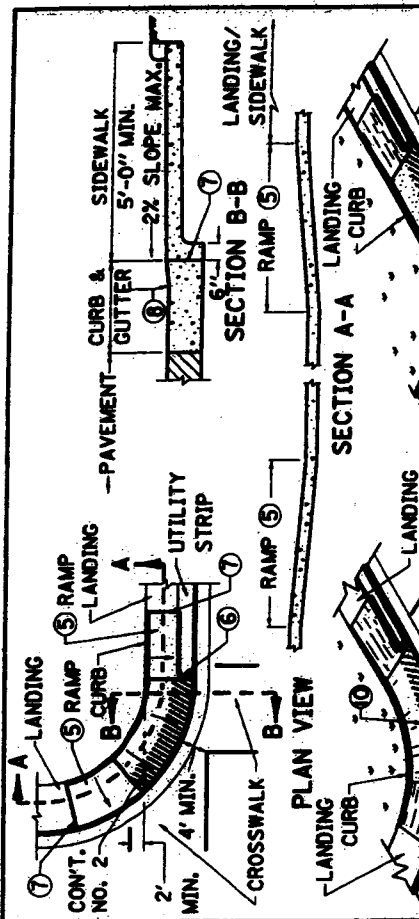
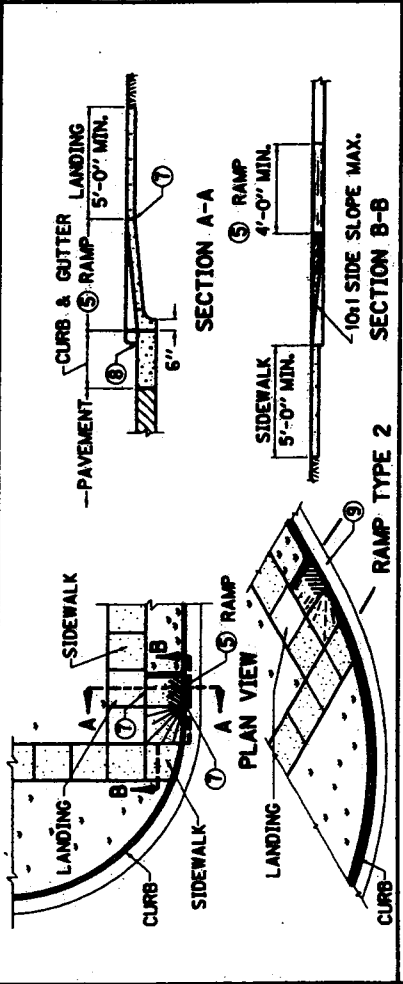
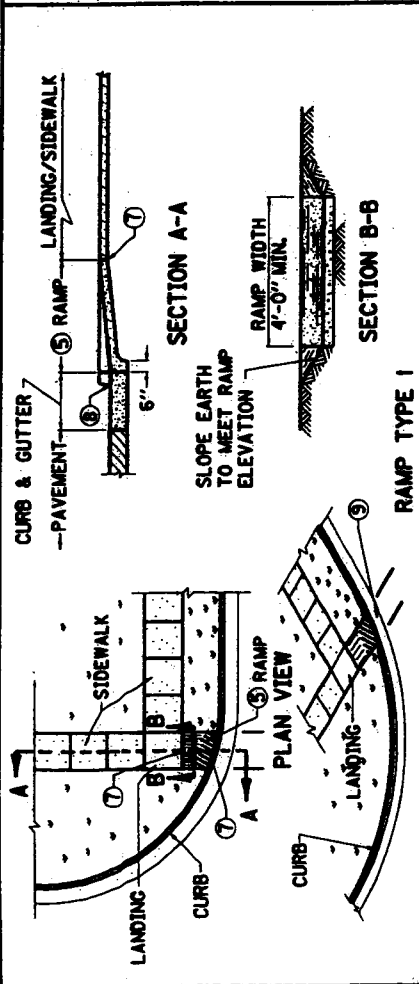

BID ITEMS AND UNIT TO BID
SIDEWALK-4 IN CONCRETE
DETECTABLE WARNINGS

**SOYD
SOFT**

NOTES

1. THE RAMP SHALL BE CONSTRUCTED OF CLASS "A" CONCRETE. A BROOM FINISH OR EQUAL NON-SKID FINISH IS REQUIRED. DETECTABLE WARNINGS SHALL BE A SEPARATE BID ITEM.
2. RAMPS SHALL BE PAID PER SQ. YD. OF 4" CONCRETE SIDEWALK AND THE UNIT PRICE SHALL INCLUDE ALL MATERIALS, FORMS, CURB BEHIND RAMP AND LANDING, AND INCIDENTALS NECESSARY FOR CONSTRUCTION.
3. THE NORMAL GUTTER LINE SHALL BE MAINTAINED THROUGH THE AREA OF THE RAMP.
4. RAMP TYPE 3 SHOULD BE USED PRIMARILY IN A RETROFIT TYPE CONDITION.
5. CURB RAMP GRADE SHALL NOT EXCEED 12:1. CROSS SLOPE SHALL NOT EXCEED 2% ON RETROFIT CURB RAMPS. GRADES OF 12.5:1 OR 2:0" OR 10:1 ARE PERMISSIBLE.
6. CURB RETURN REQUIRED WHEN UTILITY STRIP IS 4' OR GREATER. FOR UTILITY STRIPS LESS THAN 4', THE AREA IS TO BE SURFACED WITH SIDEWALK WITHIN THE RAMP.
7. 1/2" EXPANSION JOINT AT BACK OF CURB LINE AND AT SIDEWALK LINE.
8. NO BUMP PERMITTED. SAME SLOPE AS RAMP AND NOT TO EXCEED 1" IN HEIGHT. RAMPS SHALL BE CONSTRUCTED SO THAT WATER WILL NOT ACCUMULATE ON WALKING SURFACES.
9. LANDINGS WILL PROVIDE A LEVEL AREA (MAX. 5% GRADE OR CROSS SLOPE) AT APPROXIMATE STREET ELEVATION. A 4' SQUARE LEVEL LANDING IS THE REQUIRED MINIMUM.
10. LANDINGS WILL PROVIDE A LEVEL AREA (MAX. 2% GRADE OR CROSS SLOPE) AT APPROXIMATE STREET ELEVATION. A 4' SQUARE LEVEL LANDING IS THE REQUIRED MINIMUM.

USE WITH CUR. STD. DWG.
RCX-040

KENTUCKY
DEPARTMENT OF HIGHWAYS

SIDEWALK
RAMPS

STANDARD DRAWING NO. RPM-170-09
SUBMITTED 12-01-15
APPROVED 12-01-15

DROP CURB FOR RAMP

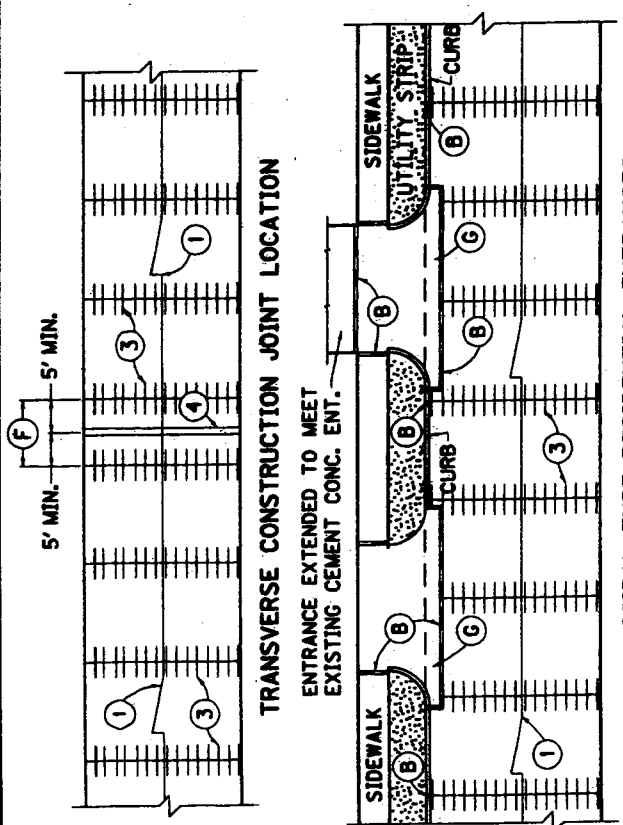

- NOTES**
1. SEE CUR. STD. DWG. RPS-010 FOR JOINT SYMBOLS AND DETAILS.
 2. THE INSTALLATION OF LONGITUDINAL SAWS AND CONSTRUCTION JOINTS IN TURNOUTS SHALL DEPEND ON THE WIDTH OF THE TURNOUT WITH THE RULE THAT 16' SHALL BE THE MAXIMUM POUR WITHOUT CONSTRUCTION OF A LONGITUDINAL JOINT.
 3. ALL INTEGRAL CURBS CONSTRUCTED WITH CONCRETE BASE OR PAVEMENT SHALL HAVE JOINTS COINCIDING WITH THE TRANSVERSE JOINTS AND OTHER JOINTS SHOWN ON THIS STANDARD DRAWING. THE JOINTS SHALL BE FILLED WITH 1/2" PREMOLDED EXPANSION JOINT FILLER, CUT TO REQUIRED SECTION.
 - (A) THIS DISTANCE TO BE EQUALLY DIVIDED WHEN GREATER THAN 20' AND LESS THAN 40'.
 - (B) 1/2" EXPANSION JOINT FILLER.
 - (C) NO TRANSVERSE JOINT WILL BE REQUIRED IF THE DISTANCE IS LESS THAN NORMAL SPACING OF JOINTS.
 - (D) NORMAL SPACING OF CONTRACTION JOINTS.
 - (E) EQUALLY DIVIDE AND CONSTRUCT LONGITUDINAL SAWS JOINT WHEN WIDTH OF CROSSOVER BECOMES GREATER THAN 16' AND LESS THAN 24'. WHEN WIDTH BECOMES GREATER THAN 24', A LONGITUDINAL SAWS AND LONGITUDINAL CONSTRUCTION JOINT SHALL BE CONSTRUCTED IN THE CROSSOVER.
 - (F) NORMAL SPACING OF TRANSVERSE CONTRACTION JOINTS.
 - (G) SEE CUR. STD. DWG. RPM-150 OR RPM-152, AS APPLICABLE FOR MORE DETAIL.

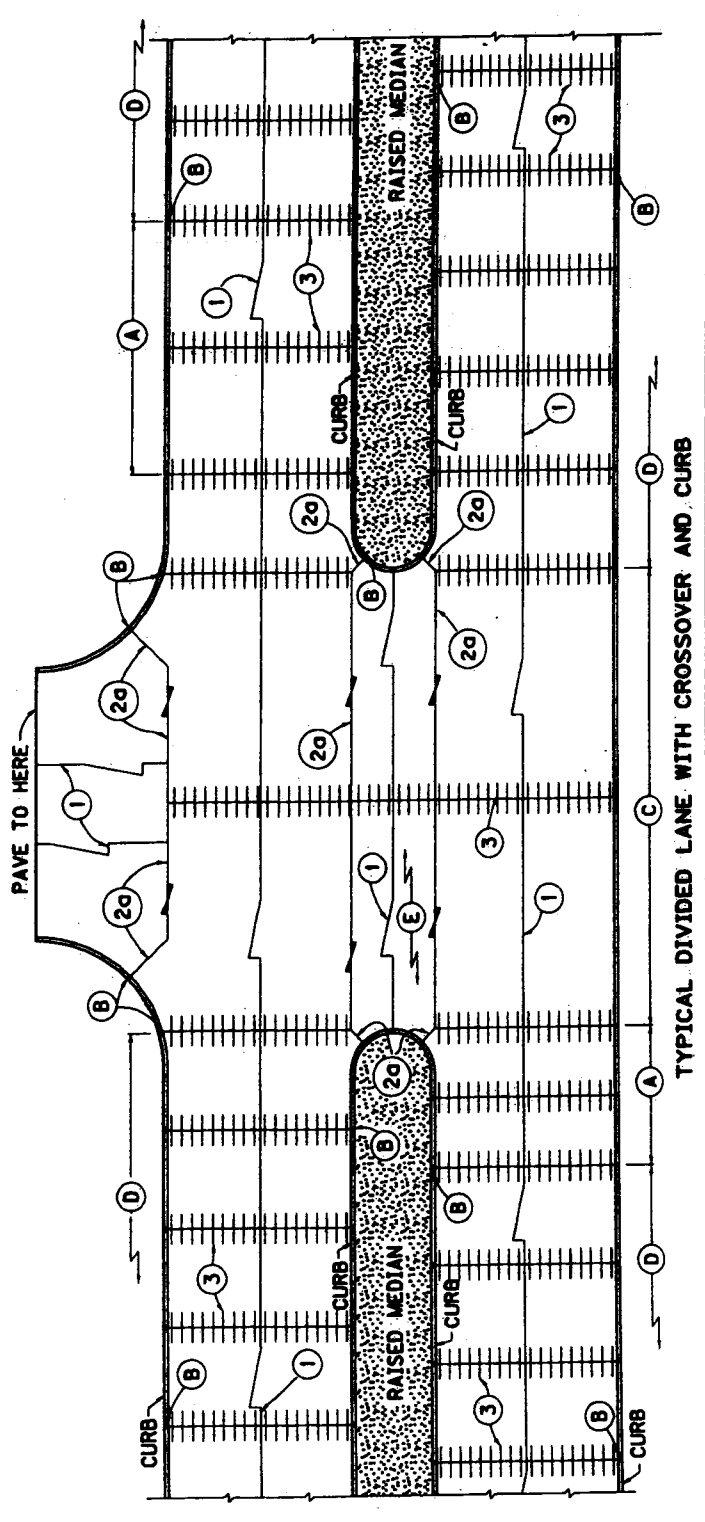

USE WITH CUR. STD. DWG.
RPM-150, RPM-152, RPS-010

KENTUCKY
DEPARTMENT OF HIGHWAYS

CONCRETE
PAVEMENT JOINTS
TYPES AND SPACING

STANDARD DRAWING NO. RPS-033-07
12-01-15
12-01-15

- ~ NOTES ~
- A EQUALLY DIVIDE AND CONSTRUCT LONGITUDINAL SAWED JOINT WHEN DISTANCE BECOMES GREATER THAN 16'.
 - B 1/2" EXPANSION JOINT FILLER.
 - C TRANSVERSE CONTRACTION JOINT REQUIRED ONLY WHEN DISTANCE IN EXCESS OF NORMAL SPACING OF CONTRACTION JOINTS.
 - D NO CONTRACTION JOINTS REQUIRED BETWEEN THESE TWO CONTRACTION JOINTS WHEN DISTANCE IS LESS THAN NORMAL SPACING OF JOINTS. EQUALLY DIVIDE WHEN DISTANCE IS GREATER THAN 20' AND LESS THAN 40'.
 - E ALL INTEGRAL CURBS CONSTRUCTED WITH CONCRETE BASE OR PAVEMENT SHALL HAVE JOINTS COINCIDING WITH THE TRANSVERSE JOINTS AND OTHER JOINTS SHOWN ON THIS STANDARD DRAWING.
 - F THE JOINTS SHALL BE FILLED WITH 1/2" PREMOLDED EXPANSION JOINT FILLER, CUT TO THE REQUIRED SECTION.
 - G. SEE CUR. STD. DWG. RPS-010 FOR JOINT SYMBOLS AND DETAILS.
 - AA THIS DISTANCE TO BE EQUALLY DIVIDED WHEN GREATER THAN 20' AND LESS THAN 40'.

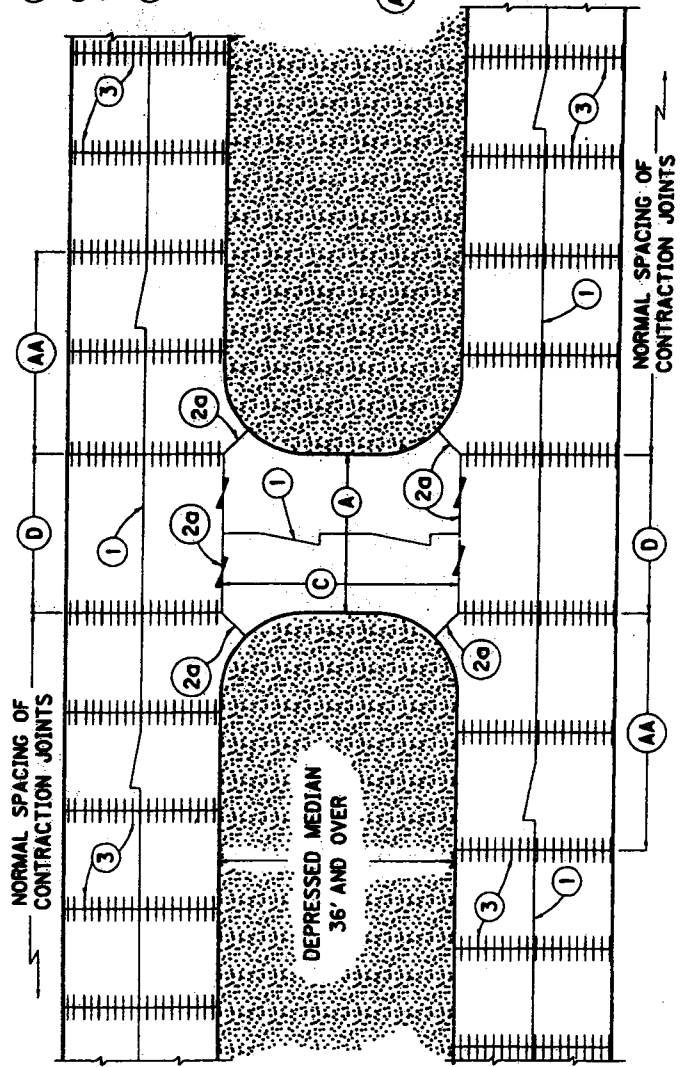

TYPICAL DIVIDED PAVEMENT WITH DEPRESSED MEDIAN AND CROSSOVER

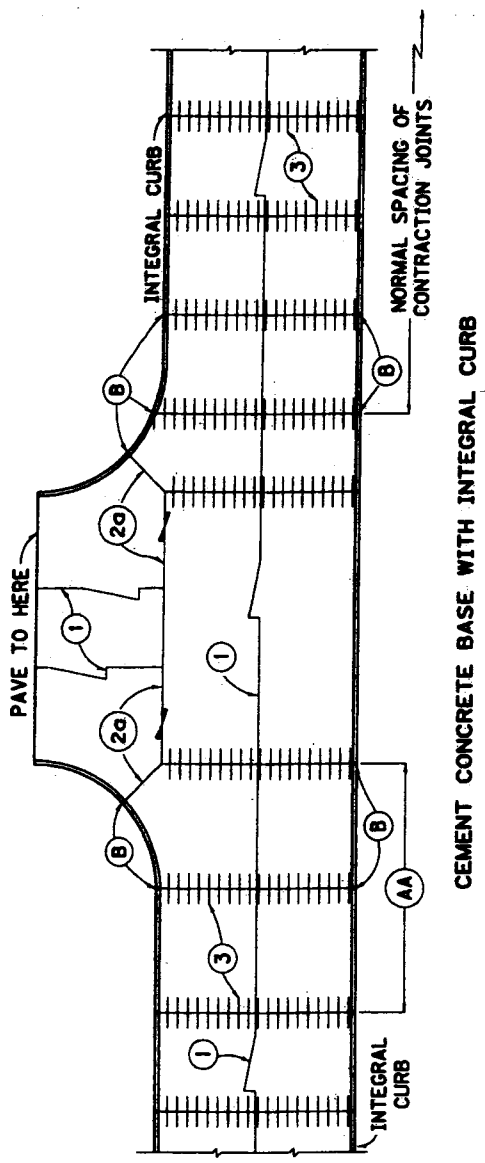

CEMENT CONCRETE BASE WITH INTEGRAL CURB

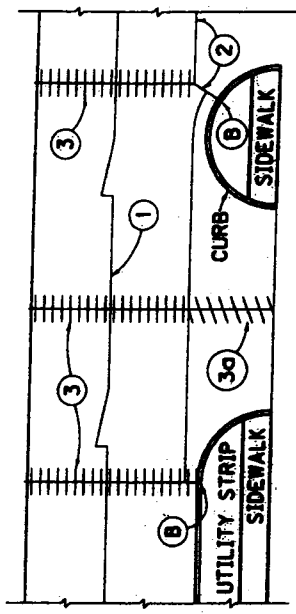

COMMERCIAL ENTRANCE

USE WITH CUR. STD. DWG.
RPS-010

KENTUCKY
DEPARTMENT OF HIGHWAYS

CONCRETE
PAVEMENT JOINTS
TYPES AND SPACING

STANDARD DRAWING NO. RPS-034-01
SUBMITTED 12-01-15
APPROVED 12-01-15

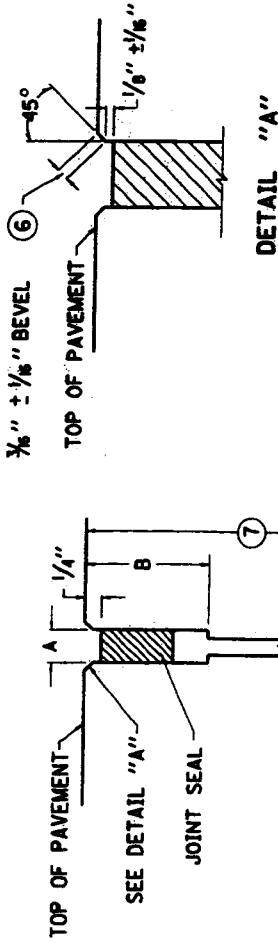

JOINT SHAPE FOR
TRANSVERSE SAWED CONTRACTION JOINT

JOINT SPACING	DIMENSIONS			SEAL WIDTH UNCOMPRESSED
	A	B	C	
15'-0"	3/8"	2"	1/8" TO 3/8"	3/8"
25'-0"	1/2"	2"	1/8" TO 1/2"	1"
50'-0"	3/4"	2"	1/8" TO 3/4"	1 1/4"

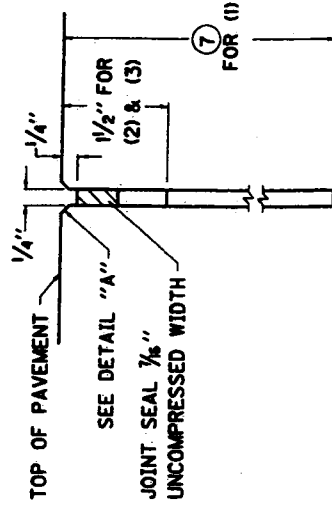

JOINT SHAPE FOR
LONGITUDINAL SAWED JOINT (TIED)

- (1) LONGITUDINAL SAWED JOINT (TIED)
- (2) LONGITUDINAL SAWED CONSTRUCTION JOINT (TIED)
- (3) TRANSVERSE SAWED CONSTRUCTION JOINT (TIED)

NOTES

1. PAYMENT FOR ALL WORK SHALL BE INCIDENTAL TO THE UNIT PRICE BID PER SQ. YD. OF PAVEMENT.
2. TOLERANCES ON ALL JOINT WIDTH DIMENSIONS PLUS OR MINUS 1/16".
3. INSTALLATION OF PREFORMED POLYCHLOROPRENE SEALS (NEOPRENE) SHALL BE IN ACCORDANCE WITH SECTION 501.03.1B OF THE CURRENT STANDARD SPECIFICATIONS FOR ROAD AND BRIDGE CONSTRUCTION, CURRENT EDITION, EXCEPT TRANSVERSE EXPANSION JOINTS SHALL RECEIVE PREFORMED SEALS IN ACCORDANCE WITH THIS DRAWING.
4. THE REMAINING JOINT SHALL BE IN ACCORDANCE WITH CUR. STD. DWGS. RPS-010 AND RPS-020.
5. ALL LONGITUDINAL AND TRANSVERSE SAWED CONSTRUCTION JOINTS SHALL BE CUT TO THE DEPTH SHOWN AND SHALL BE SEALED WITH HOT POURED ELASTIC JOINT SEAL.
6. THESE EDGES SHALL BE BEVELED USING A CUTTING OR GRINDING DEVICE. JOINT DEPTH IS T/3 OR 4", WHICHEVER IS LESS.
7. T = PAVEMENT THICKNESS

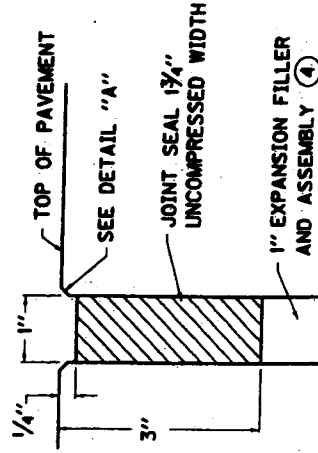

JOINT SHAPE FOR
TRANSVERSE EXPANSION JOINT

USE WITH CUR. STD. DWGS.
RPS-010, RPS-020

KENTUCKY

DEPARTMENT OF HIGHWAYS

PREFORMED COMPRESSION
JOINT SEAL FOR
CONCRETE PAVEMENT

STANDARD DRAWING NO. RPS-010-05

SUBMITTED 12-26-15

APPROVED 12-01-15

COUNTY OF	ITEM NO.	SHEET NO.
FAVETTE	7-3304	12

SPECIAL NOTE:
DISCONNECTS (SAFETY SWITCH AND METER BASE SHALL BE UL RATED FOR COMMERCIAL USE. ALL DISCONNECTS AND METER BASE SHALL BE ALUMINUM ENCLOSURE. THE CONTRACTOR SHALL BE RESPONSIBLE TO CALCULATE THE MAXIMUM AVAILABLE FAULT CURRENT FOR THE MOUNTING BRACKET. THE DISCONNECT SHALL BE INSTALLED WITH THE SYMMETRICAL RMS AMPERES AND THE DATE THAT THIS FAULT CURRENT IS CALCULATED. THE STICKER PLAYS FROM STICKER LABEL FOR APPROVED EQUALI WITH .007 THICKNESS. WITH UV WHITE POLYCARBONATE MATERIAL AND WITH MCTB PRESSURE SENSITIVE ADHESIVE OR APPROVED EQUAL.

NOTES:
ALL CONDUITS USED FOR THE TELEPHONE, GROUNDING, SPARES, AND SERVICE WIRE SHALL BE INSTALLED IN THE CABINET BASE. THE CONDUIT SHALL BE INSTALLED TO BID ITEM #931. THIS INCLUDES PROVIDING A MINIMUM OF 24 INCHES OF CONDUIT PAST THE EDGE OF THE CONCRETE PAD.
ALL CONDUITS SHALL BE INSTALLED BETWEEN 4 TO 6 INCHES ABOVE THE CONCRETE PAD, AND THEY CANNOT EXCEED THE 6 INCH HEIGHT.
SERVICE WIRES FOR BASE MOUNTED CABINETS MAY BE INSTALLED IN FLEXIBLE CONDUIT FROM THE DISCONNECT TO THE 1" RIGID STEEL CONDUIT INSIDE THE POLE BASE. USE THE PROPER CONNECTIONS FOR CONNECTION FROM FLEXIBLE CONDUIT TO R/S CONDUIT. FLEXIBLE CONDUIT SHALL BE INSTALLED TO LOCK THE HOLE ON THE ABILITY TO ACCESS THE GROUNDING SYSTEM.

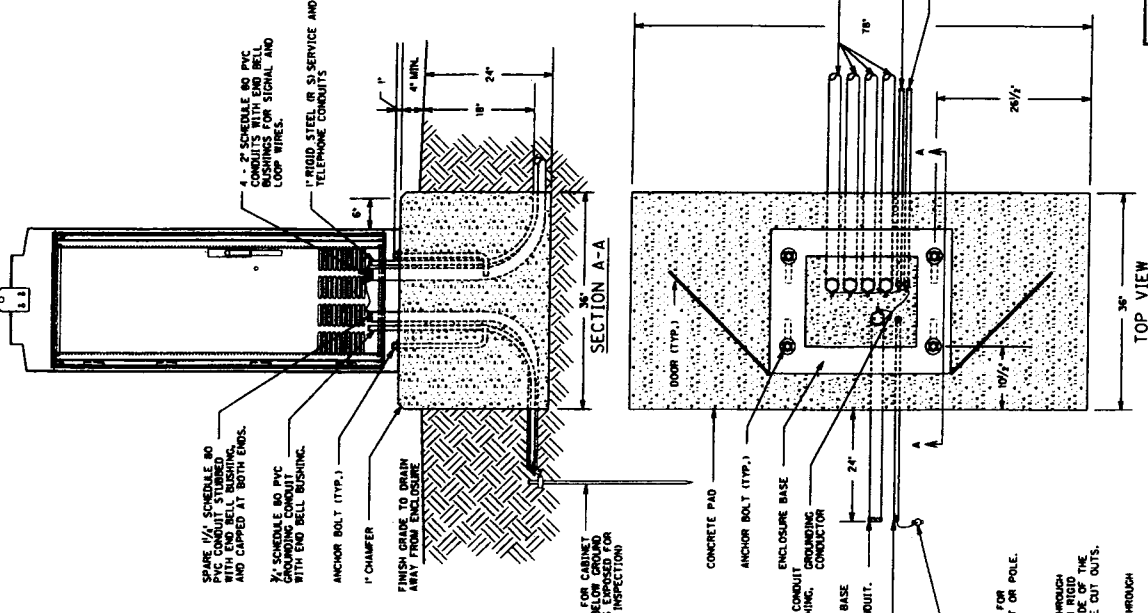
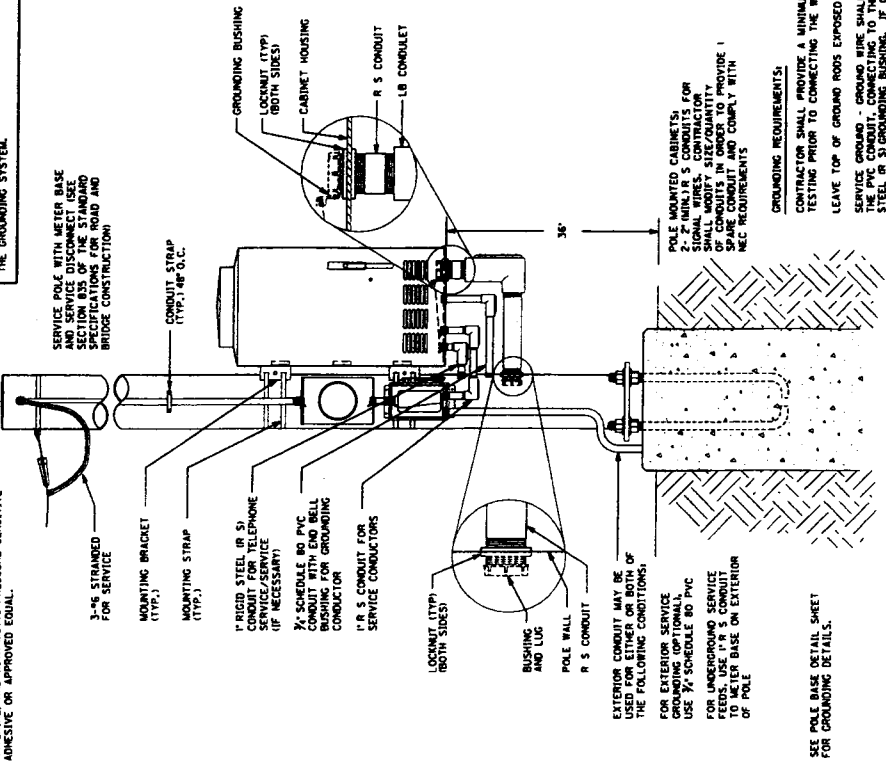

COUNTY OF	ITEM NO.	SHEET NO.
FAVETTE	7-3304	12

GROUNDING REQUIREMENTS:
CONTRACTOR SHALL PROVIDE A MINIMUM OF 6 INCHES OF GROUND WIRE FOR TESTING PRIOR TO CONNECTING THE WIRE TO ANY DISCONNECT, CABINET OR POLE.
LEAVE TOP OF GROUND RODS EXPOSED FOR ELECTRICAL INSPECTION.
SERVICE GROUND - GROUND WIRE SHALL COME FROM THE GROUND ROD THROUGH THE PVC CONDUIT, CONNECTING TO THE DISCONNECT. IF GROUND WIRE IS RUN ON THE INSIDE OF THE POLE, RUBBER GROMMETS SHALL BE PROVIDED AT DISCONNECT AND POLE CUT OUTS. THEY SHALL BE INCIDENTAL TO BID ITEM #931.
CABINET GROUND - GROUND WIRE SHALL COME FROM THE GROUND ROD THROUGH THE PVC CONDUIT, CONNECTING TO THE CABINET GROUND BUS.

GROUNDING REQUIREMENTS:
CONTRACTOR SHALL PROVIDE A MINIMUM OF 6 INCHES OF GROUND WIRE FOR TESTING PRIOR TO CONNECTING THE WIRE TO ANY DISCONNECT, CABINET OR POLE.
LEAVE TOP OF GROUND RODS EXPOSED FOR ELECTRICAL INSPECTION.
SERVICE GROUND - GROUND WIRE SHALL COME FROM THE GROUND ROD THROUGH THE PVC CONDUIT, CONNECTING TO THE DISCONNECT. IF GROUND WIRE IS RUN ON THE INSIDE OF THE POLE, RUBBER GROMMETS SHALL BE PROVIDED AT DISCONNECT AND POLE CUT OUTS. THEY SHALL BE INCIDENTAL TO BID ITEM #931.
CABINET GROUND - GROUND WIRE SHALL COME FROM THE GROUND ROD THROUGH THE PVC CONDUIT, CONNECTING TO THE CABINET GROUND BUS.

QUANTITY OF	ITEM NO.	SHEET NO.
FAVETTE	7-3004	13

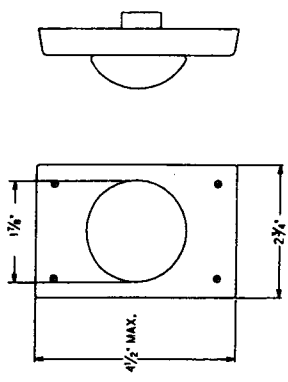
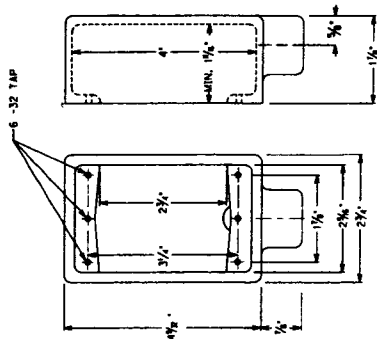
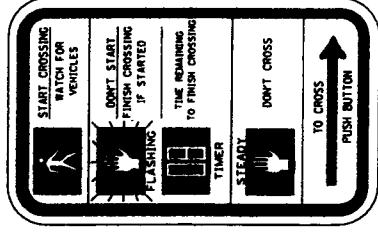

TYPE FS BOX FOR PED DETECTOR FOR USE WITH STEEL STRAIN POLE, WOOD POST, PEDESTAL, AND WOOD POLE

RI0-3e SIGN (9' X 15') FOR COUNTDOWN ONLY

PED DETECTOR

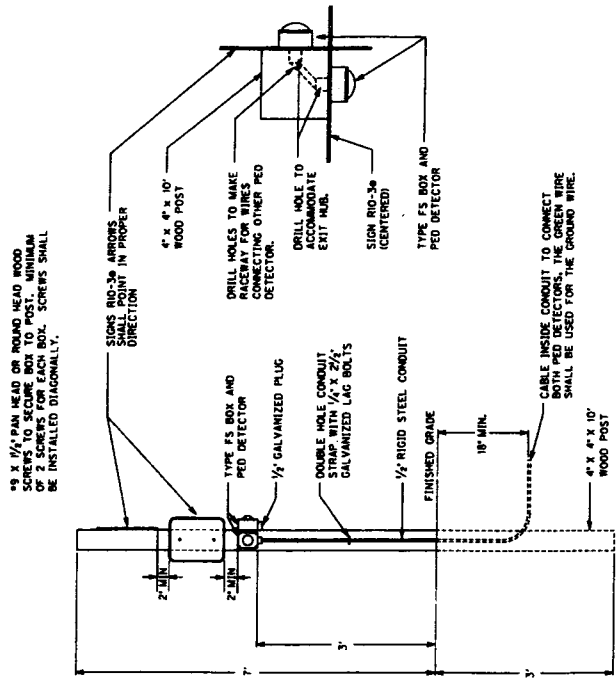
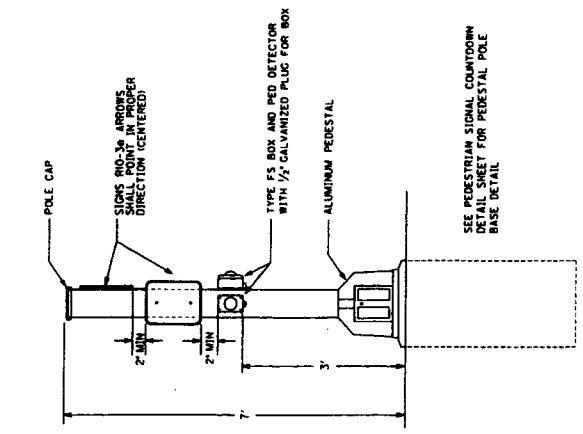

PEDESTAL POST DETAIL FOR PED DETECTORS & SIGNS

PED DETECTOR ON WOOD POST DETAIL

6/22/2012

PEDESTRIAN DETECTOR DETAIL

COUNTY OF	ITEM NO.	SHEET NO.
FAYETTE	7-3804	14

NOTE:
 ALL GROUNDING AND SPARE CONDUITS THAT ARE INSTALLED IN THE CONCRETE PEDESTAL SHALL BE INSTALLED PRIOR TO THE POURING OF THIS CONCRETE. THIS INCLUDES PROVIDING A MINIMUM OF 6 INCHES OF CONDUIT PAST THE EDGE OF THE CONCRETE BASE. AN ARROW SHALL BE DRAWN TO THE TOP OF THE PEDESTAL BASE TO SHOW LOCATION AND DIRECTION OF THE SPARE CONDUIT.
GROUNDING REQUIREMENTS:
 CONTRACTOR SHALL PROVIDE A MINIMUM OF 6 INCHES OF GROUND WIRE FOR TESTING PRIOR TO CONNECTING THE WIRE TO THE TRANSFORMER BASE.
 LEAVE TOP OF GROUND RODS EXPOSED FOR ELECTRICAL INSPECTION.
 PEDESTAL POLE GROUND - GROUND WIRE SHALL COME FROM THE GROUND ROD THROUGH THE PVC CONDUIT, CONNECTING TO A GROUND LUG ON THE TRANSFORMER BASE AND THEN TO EACH RIGID STEEL GROUNDING BUSHING.

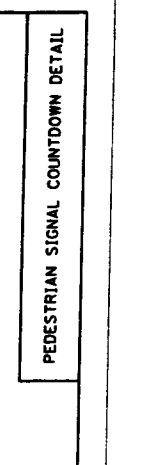
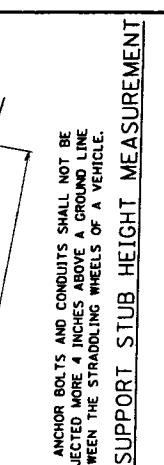
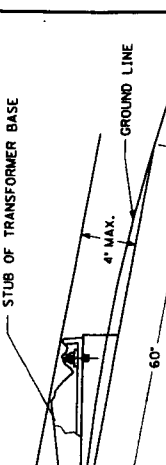
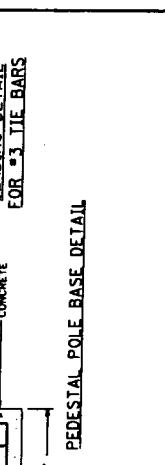
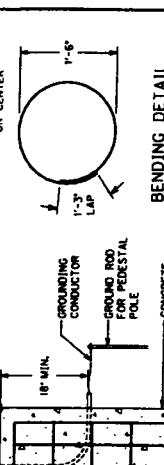
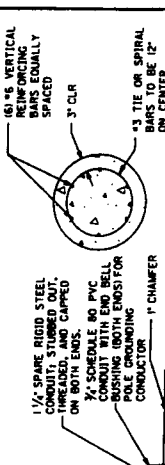
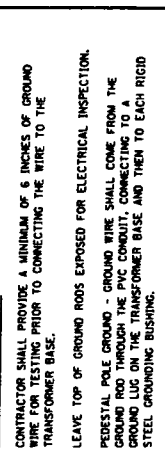

NOTE:
 PEDESTAL BASE RODS SHALL HAVE A 1/4\"/>

NOTE:
 CONTRACTOR SHALL DRILL HOLES IN THE STEEL STRAIN POLE AND THE TYPE FS BOX NOT EXCEEDING 1/4\"/>

NOTE:
 CONTRACTOR SHALL DRILL HOLES IN THE PIPE AND THE TYPE FS BOX NOT EXCEEDING 1/4\"/>

NOTE:
 CONTRACTOR SHALL DRILL HOLES IN THE PIPE AND THE TYPE FS BOX NOT EXCEEDING 1/4\"/>

NOTE:
 CONTRACTOR SHALL DRILL HOLES IN THE PIPE AND THE TYPE FS BOX NOT EXCEEDING 1/4\"/>

NOTE:
 CONTRACTOR SHALL DRILL HOLES IN THE PIPE AND THE TYPE FS BOX NOT EXCEEDING 1/4\"/>

NOTE:
 CONTRACTOR SHALL DRILL HOLES IN THE PIPE AND THE TYPE FS BOX NOT EXCEEDING 1/4\"/>

NOTE:
 CONTRACTOR SHALL DRILL HOLES IN THE PIPE AND THE TYPE FS BOX NOT EXCEEDING 1/4\"/>

NOTE:
 CONTRACTOR SHALL DRILL HOLES IN THE PIPE AND THE TYPE FS BOX NOT EXCEEDING 1/4\"/>

NOTE:
 CONTRACTOR SHALL DRILL HOLES IN THE PIPE AND THE TYPE FS BOX NOT EXCEEDING 1/4\"/>

NOTE:
 CONTRACTOR SHALL DRILL HOLES IN THE PIPE AND THE TYPE FS BOX NOT EXCEEDING 1/4\"/>

NOTE:
 CONTRACTOR SHALL DRILL HOLES IN THE PIPE AND THE TYPE FS BOX NOT EXCEEDING 1/4\"/>

NOTE:
 CONTRACTOR SHALL DRILL HOLES IN THE PIPE AND THE TYPE FS BOX NOT EXCEEDING 1/4\"/>

NOTE:
 CONTRACTOR SHALL DRILL HOLES IN THE PIPE AND THE TYPE FS BOX NOT EXCEEDING 1/4\"/>

NOTE:
 CONTRACTOR SHALL DRILL HOLES IN THE PIPE AND THE TYPE FS BOX NOT EXCEEDING 1/4\"/>

NOTE:
 CONTRACTOR SHALL DRILL HOLES IN THE PIPE AND THE TYPE FS BOX NOT EXCEEDING 1/4\"/>

NOTE:
 CONTRACTOR SHALL DRILL HOLES IN THE PIPE AND THE TYPE FS BOX NOT EXCEEDING 1/4\"/>

NOTE:
 CONTRACTOR SHALL DRILL HOLES IN THE PIPE AND THE TYPE FS BOX NOT EXCEEDING 1/4\"/>

NOTE:
 CONTRACTOR SHALL DRILL HOLES IN THE PIPE AND THE TYPE FS BOX NOT EXCEEDING 1/4\"/>

NOTE:
 CONTRACTOR SHALL DRILL HOLES IN THE PIPE AND THE TYPE FS BOX NOT EXCEEDING 1/4\"/>

NOTE:
 CONTRACTOR SHALL DRILL HOLES IN THE PIPE AND THE TYPE FS BOX NOT EXCEEDING 1/4\"/>

NOTE:
 CONTRACTOR SHALL DRILL HOLES IN THE PIPE AND THE TYPE FS BOX NOT EXCEEDING 1/4\"/>

NOTE:
 CONTRACTOR SHALL DRILL HOLES IN THE PIPE AND THE TYPE FS BOX NOT EXCEEDING 1/4\"/>

NOTE:
 CONTRACTOR SHALL DRILL HOLES IN THE PIPE AND THE TYPE FS BOX NOT EXCEEDING 1/4\"/>

NOTE:
 CONTRACTOR SHALL DRILL HOLES IN THE PIPE AND THE TYPE FS BOX NOT EXCEEDING 1/4\"/>

NOTE:
 CONTRACTOR SHALL DRILL HOLES IN THE PIPE AND THE TYPE FS BOX NOT EXCEEDING 1/4\"/>

NOTE:
 CONTRACTOR SHALL DRILL HOLES IN THE PIPE AND THE TYPE FS BOX NOT EXCEEDING 1/4\"/>

NOTE:
 CONTRACTOR SHALL DRILL HOLES IN THE PIPE AND THE TYPE FS BOX NOT EXCEEDING 1/4\"/>

NOTE:
 CONTRACTOR SHALL DRILL HOLES IN THE PIPE AND THE TYPE FS BOX NOT EXCEEDING 1/4\"/>

NOTE:
 CONTRACTOR SHALL DRILL HOLES IN THE PIPE AND THE TYPE FS BOX NOT EXCEEDING 1/4\"/>

NOTE:
 CONTRACTOR SHALL DRILL HOLES IN THE PIPE AND THE TYPE FS BOX NOT EXCEEDING 1/4\"/>

NOTE:
 CONTRACTOR SHALL DRILL HOLES IN THE PIPE AND THE TYPE FS BOX NOT EXCEEDING 1/4\"/>

NOTE:
 CONTRACTOR SHALL DRILL HOLES IN THE PIPE AND THE TYPE FS BOX NOT EXCEEDING 1/4\"/>

NOTE:
 CONTRACTOR SHALL DRILL HOLES IN THE PIPE AND THE TYPE FS BOX NOT EXCEEDING 1/4\"/>

NOTE:
 CONTRACTOR SHALL DRILL HOLES IN THE PIPE AND THE TYPE FS BOX NOT EXCEEDING 1/4\"/>

NOTE:
 CONTRACTOR SHALL DRILL HOLES IN THE PIPE AND THE TYPE FS BOX NOT EXCEEDING 1/4\"/>

NOTE:
 CONTRACTOR SHALL DRILL HOLES IN THE PIPE AND THE TYPE FS BOX NOT EXCEEDING 1/4\"/>

NOTE:
 CONTRACTOR SHALL DRILL HOLES IN THE PIPE AND THE TYPE FS BOX NOT EXCEEDING 1/4\"/>

NOTE:
 CONTRACTOR SHALL DRILL HOLES IN THE PIPE AND THE TYPE FS BOX NOT EXCEEDING 1/4\"/>

NOTE:
 CONTRACTOR SHALL DRILL HOLES IN THE PIPE AND THE TYPE FS BOX NOT EXCEEDING 1/4\"/>

NOTE:
 CONTRACTOR SHALL DRILL HOLES IN THE PIPE AND THE TYPE FS BOX NOT EXCEEDING 1/4\"/>

NOTE:
 CONTRACTOR SHALL DRILL HOLES IN THE PIPE AND THE TYPE FS BOX NOT EXCEEDING 1/4\"/>

NOTE:
 CONTRACTOR SHALL DRILL HOLES IN THE PIPE AND THE TYPE FS BOX NOT EXCEEDING 1/4\"/>

NOTE:
 CONTRACTOR SHALL DRILL HOLES IN THE PIPE AND THE TYPE FS BOX NOT EXCEEDING 1/4\"/>

NOTE:
 CONTRACTOR SHALL DRILL HOLES IN THE PIPE AND THE TYPE FS BOX NOT EXCEEDING 1/4\"/>

NOTE:
 CONTRACTOR SHALL DRILL HOLES IN THE PIPE AND THE TYPE FS BOX NOT EXCEEDING 1/4\"/>

NOTE:
 CONTRACTOR SHALL DRILL HOLES IN THE PIPE AND THE TYPE FS BOX NOT EXCEEDING 1/4\"/>

NOTE:
 CONTRACTOR SHALL DRILL HOLES IN THE PIPE AND THE TYPE FS BOX NOT EXCEEDING 1/4\"/>

NOTE:
 CONTRACTOR SHALL DRILL HOLES IN THE PIPE AND THE TYPE FS BOX NOT EXCEEDING 1/4\"/>

NOTE:
 CONTRACTOR SHALL DRILL HOLES IN THE PIPE AND THE TYPE FS BOX NOT EXCEEDING 1/4\"/>

NOTE:
 CONTRACTOR SHALL DRILL HOLES IN THE PIPE AND THE TYPE FS BOX NOT EXCEEDING 1/4\"/>

NOTE:
 CONTRACTOR SHALL DRILL HOLES IN THE PIPE AND THE TYPE FS BOX NOT EXCEEDING 1/4\"/>

NOTE:
 CONTRACTOR SHALL DRILL HOLES IN THE PIPE AND THE TYPE FS BOX NOT EXCEEDING 1/4\"/>

NOTE:
 CONTRACTOR SHALL DRILL HOLES IN THE PIPE AND THE TYPE FS BOX NOT EXCEEDING 1/4\"/>

NOTE:
 CONTRACTOR SHALL DRILL HOLES IN THE PIPE AND THE TYPE FS BOX NOT EXCEEDING 1/4\"/>

NOTE:
 CONTRACTOR SHALL DRILL HOLES IN THE PIPE AND THE TYPE FS BOX NOT EXCEEDING 1/4\"/>

NOTE:
 CONTRACTOR SHALL DRILL HOLES IN THE PIPE AND THE TYPE FS BOX NOT EXCEEDING 1/4\"/>

NOTE:
 CONTRACTOR SHALL DRILL HOLES IN THE PIPE AND THE TYPE FS BOX NOT EXCEEDING 1/4\"/>

NOTE:
 CONTRACTOR SHALL DRILL HOLES IN THE PIPE AND THE TYPE FS BOX NOT EXCEEDING 1/4\"/>

NOTE:
 CONTRACTOR SHALL DRILL HOLES IN THE PIPE AND THE TYPE FS BOX NOT EXCEEDING 1/4\"/>

NOTE:
 CONTRACTOR SHALL DRILL HOLES IN THE PIPE AND THE TYPE FS BOX NOT EXCEEDING 1/4\"/>

NOTE:
 CONTRACTOR SHALL DRILL HOLES IN THE PIPE AND THE TYPE FS BOX NOT EXCEEDING 1/4\"/>

NOTE:
 CONTRACTOR SHALL DRILL HOLES IN THE PIPE AND THE TYPE FS BOX NOT EXCEEDING 1/4\"/>

NOTE:
 CONTRACTOR SHALL DRILL HOLES IN THE PIPE AND THE TYPE FS BOX NOT EXCEEDING 1/4\"/>

NOTE:
 CONTRACTOR SHALL DRILL HOLES IN THE PIPE AND THE TYPE FS BOX NOT EXCEEDING 1/4\"/>

NOTE:
 CONTRACTOR SHALL DRILL HOLES IN THE PIPE AND THE TYPE FS BOX NOT EXCEEDING 1/4\"/>

NOTE:
 CONTRACTOR SHALL DRILL HOLES IN THE PIPE AND THE TYPE FS BOX NOT EXCEEDING 1/4\"/>

NOTE:
 CONTRACTOR SHALL DRILL HOLES IN THE PIPE AND THE TYPE FS BOX NOT EXCEEDING 1/4\"/>

NOTE:
 CONTRACTOR SHALL DRILL HOLES IN THE PIPE AND THE TYPE FS BOX NOT EXCEEDING 1/4\"/>

NOTE:
 CONTRACTOR SHALL DRILL HOLES IN THE PIPE AND THE TYPE FS BOX NOT EXCEEDING 1/4\"/>

NOTE:
 CONTRACTOR SHALL DRILL HOLES IN THE PIPE AND THE TYPE FS BOX NOT EXCEEDING 1/4\"/>

NOTE:
 CONTRACTOR SHALL DRILL HOLES IN THE PIPE AND THE TYPE FS BOX NOT EXCEEDING 1/4\"/>

THE ANCHOR BOLTS AND CONDUITS SHALL NOT BE PROJECTED MORE THAN 4 INCHES ABOVE A GROUND LINE BETWEEN THE STRADDLING WHEELS OF A VEHICLE.

*9 X 1/2\"/>

SEE PEDESTAL POLE BASE DETAIL FOR CONCRETE BASE DETAIL AND GROUNDING DETAILS

CONTRACTOR SHALL DRILL HOLES IN THE STEEL STRAIN POLE AND THE TYPE FS BOX NOT EXCEEDING 1/4\"/>

SEE POLE BASE DETAIL FOR CONCRETE BASE DETAIL AND GROUNDING DETAILS

COUNTY OF	FAVETTE	ITEM NO.	7-3204	SHEET NO.	15
-----------	---------	----------	--------	-----------	----

NOTES:
 ALL CONDUITS USED FOR THE TELEPHONE, GROUNDING, SPARE, AND SERVICE THAT ARE INSTALLED IN THE POLE BASE ARE INCIDENTAL TO BID ITEM "2237EM". THIS INCLUDES PROVIDING A MINIMUM OF 24 INCHES OF CONDUIT PAST THE EDGE OF THE CONCRETE POLE BASE.
 ALL CONDUITS SHALL BE INSTALLED BETWEEN 4 TO 6 INCHES ABOVE THE CONCRETE PAD, AND THEY CANNOT EXCEED THE 6 INCH HEIGHT.
 FOR POLE BASE DEPTH SEE CHART IN SECTION 723 OF THE KENTUCKY STANDARD SPECIFICATIONS FOR ROAD AND BRIDGE CONSTRUCTION, CURRENT EDITION.
 OVERHEAD SERVICE WIRES SHALL BE INSTALLED ON THE EXTERIOR OF THE POLE IN A 1" RIGID STEEL CONDUIT WITH WEATHERHEAD, OR ON THE INSIDE THE STEEL STRAIN POLE IN FLEXIBLE CONDUIT.
 UNDERGROUND SERVICE WIRES SHALL BE INSTALLED IN RIGID STEEL CONDUIT AS SHOWN ON THE CONTROLLED CABINET DETAIL SHEET.

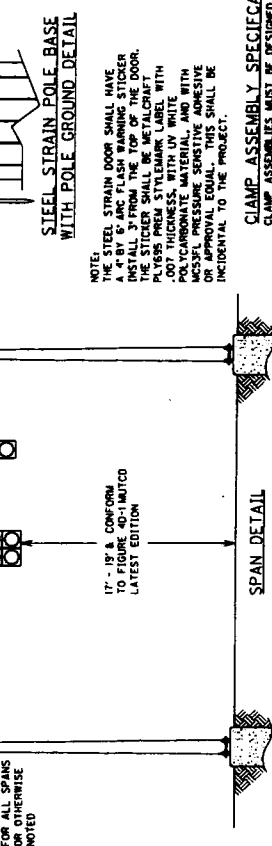
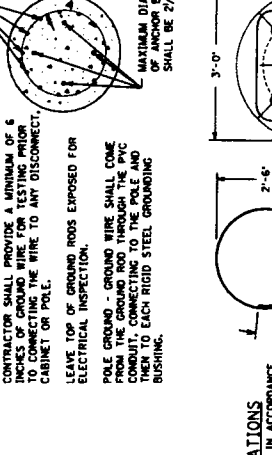
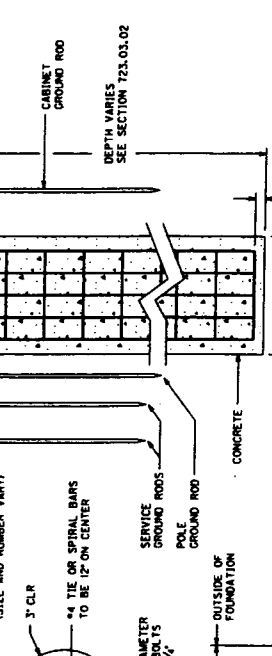
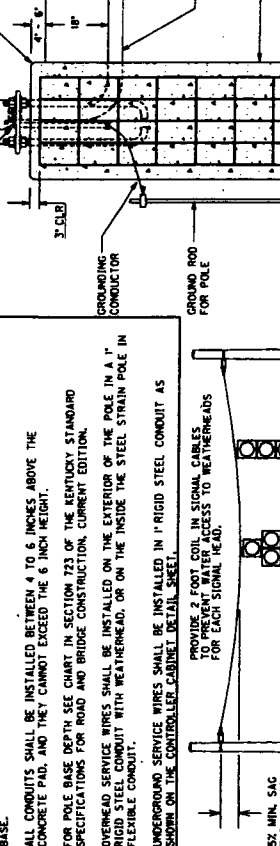
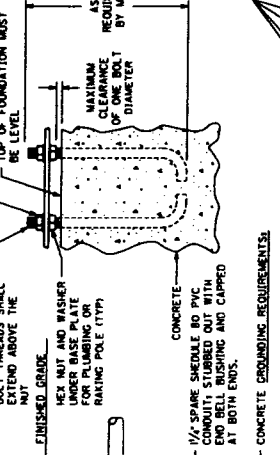
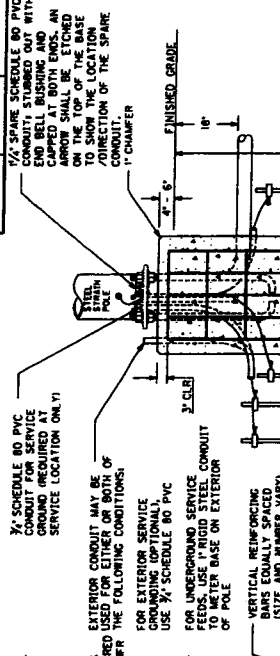

NOTE:
 THE STEEL STRAIN DOOR SHALL HAVE A 4 BY 6 ARC FLASH WARNING STICKER INSTALLED 3" FROM THE TOP OF THE DOOR. THE STICKER SHALL BE ATTACHED WITH PLYERS FROM STALEMARK LABEL WITH .007 THICKNESS, WITH UV WHITE POLYCARBONATE MATERIAL, AND WITH ACSF, PRESSURE SENSITIVE ADHESIVE. ALL LABELS SHALL BE INCIDENTAL TO THE PROJECT.

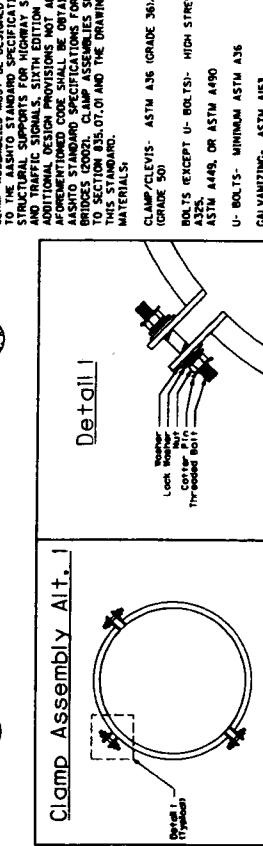
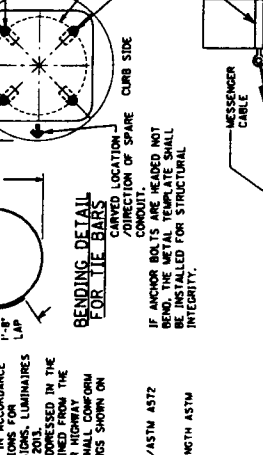
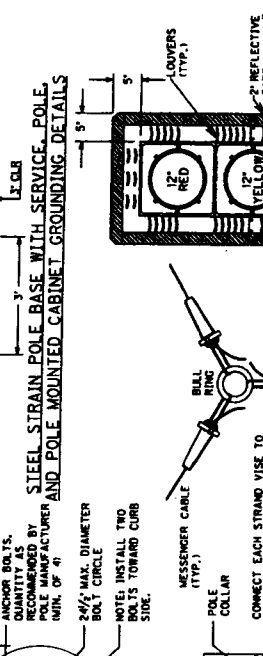

NOTE:
 CONTRACTOR SHALL PROVIDE A MINIMUM OF 6 INCHES OF CONDUIT FOR TESTING PRIOR TO CONNECTING THE WIRE TO ANY DISCONNECT, CABINET OR POLE.
 LEAVE TOP OF GROUND RODS EXPOSED FOR ELECTRICAL INSPECTION.
 POLE GROUND - GROUND WIRE SHALL COME FROM THE GROUND ROD THROUGH THE PVC CONDUIT, CONNECTING TO THE POLE AND BUSHING, EACH RIGID STEEL GROUNDING.

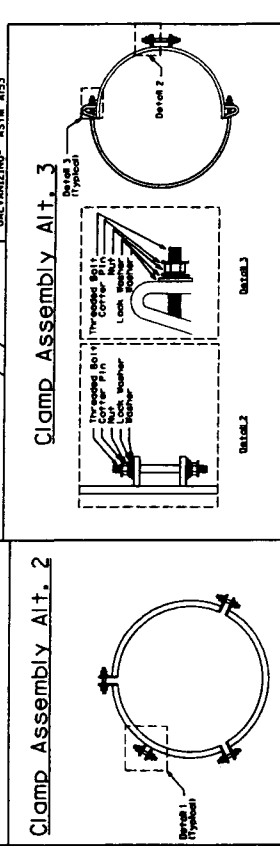
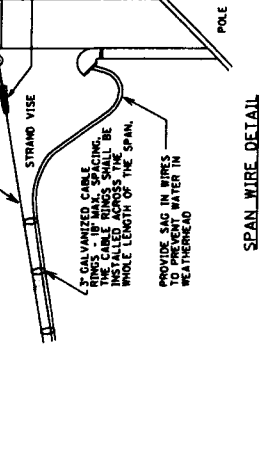
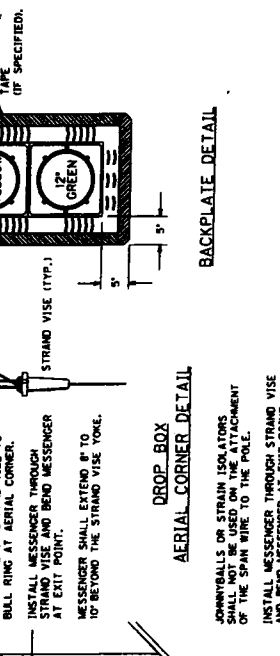

NOTE:
 CLAMP ASSEMBLY SPECIFICATIONS FOR STRUCTURAL SUPPORTS FOR HIGHWAY SIGNS, LUMINAIRES AND TRAFFIC SIGNALS, SIXTH EDITION 2011. THE APPOINTMENT CODE SHALL BE OBTAINED FROM THE ASHTO STANDARD SPECIFICATIONS FOR HIGHWAY BRIDGES (2002). CLAMP ASSEMBLIES SHALL CONFORM TO SECTION B36.07 AND THE DRAWINGS SHOWN ON MATERIALS:
 CLAMP/CLEVIS - ASTM A36 (GRADE 36)/ASTM A572 (GRADE 50)
 BOLTS (EXCEPT U-BOLTS) - HIGH STRENGTH ASTM A325
 ASTM A449, OR ASTM A490
 U-BOLTS - MINIMUM ASTM A36
 GALVANIZING - ASTM A153

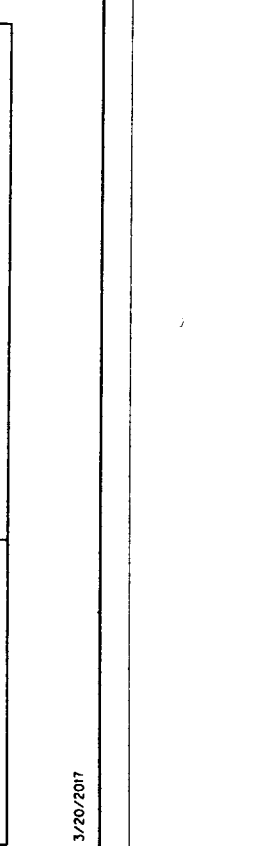
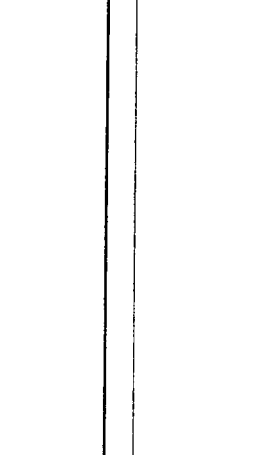
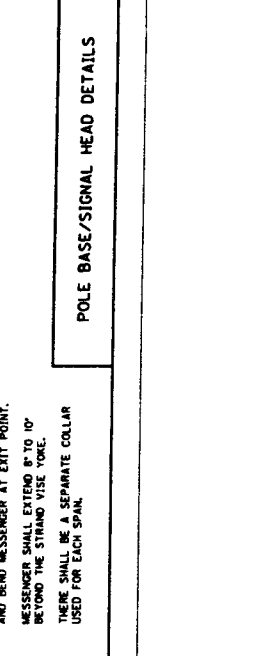

NOTE:
 CLAMP ASSEMBLY SPECIFICATIONS FOR STRUCTURAL SUPPORTS FOR HIGHWAY SIGNS, LUMINAIRES AND TRAFFIC SIGNALS, SIXTH EDITION 2011. THE APPOINTMENT CODE SHALL BE OBTAINED FROM THE ASHTO STANDARD SPECIFICATIONS FOR HIGHWAY BRIDGES (2002). CLAMP ASSEMBLIES SHALL CONFORM TO SECTION B36.07 AND THE DRAWINGS SHOWN ON MATERIALS:
 CLAMP/CLEVIS - ASTM A36 (GRADE 36)/ASTM A572 (GRADE 50)
 BOLTS (EXCEPT U-BOLTS) - HIGH STRENGTH ASTM A325
 ASTM A449, OR ASTM A490
 U-BOLTS - MINIMUM ASTM A36
 GALVANIZING - ASTM A153

COUNTY OF	ITEM NO.	SHEET NO.
FAYETTE	7-3804	16

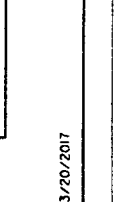
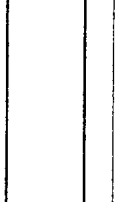
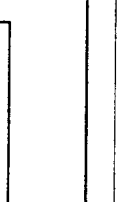
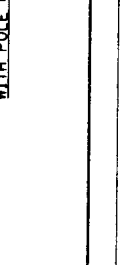
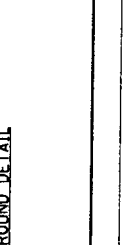
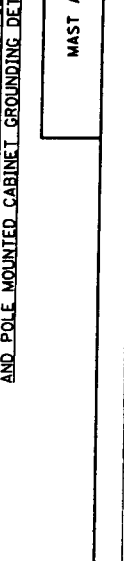
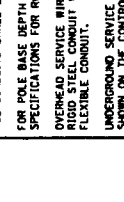
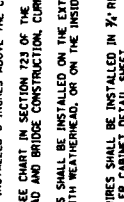
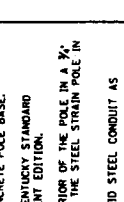
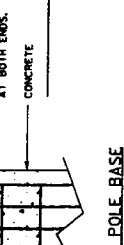
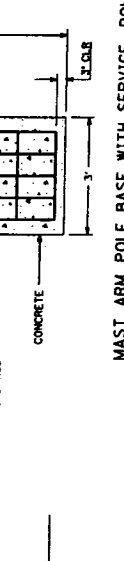
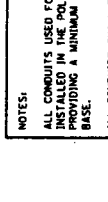
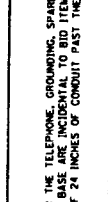
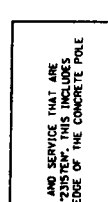
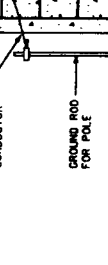
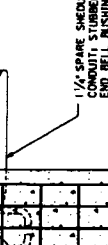
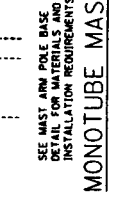
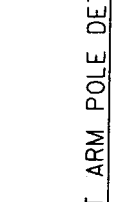
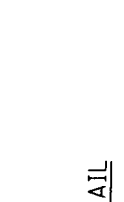
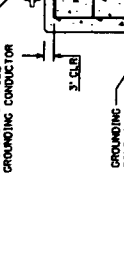
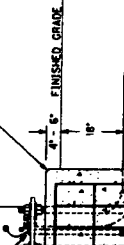
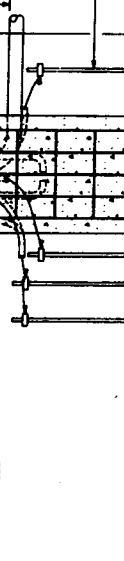
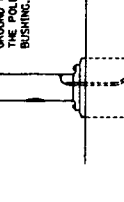
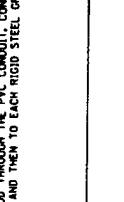
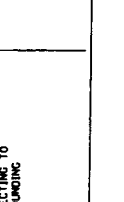
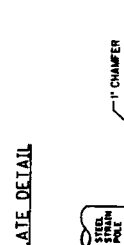
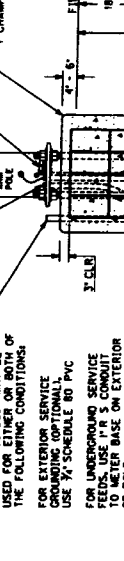
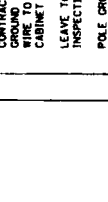
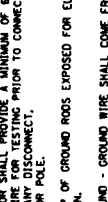
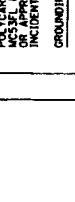
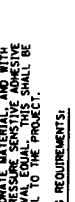
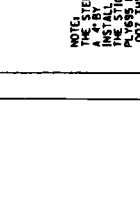
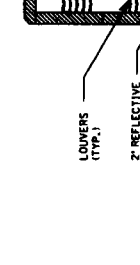
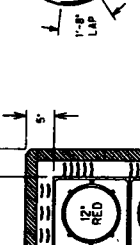
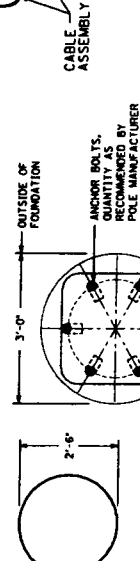
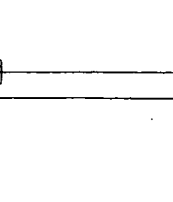
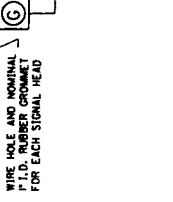
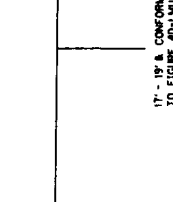
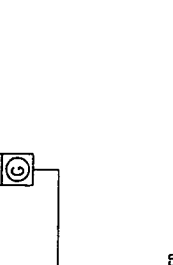
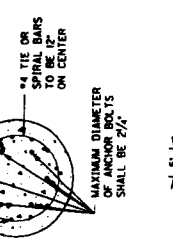
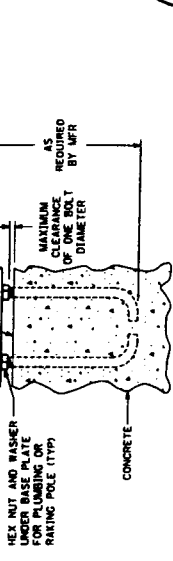
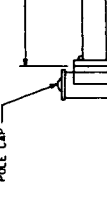
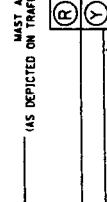
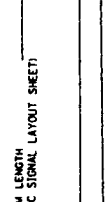
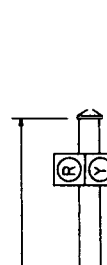
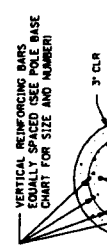
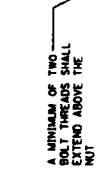
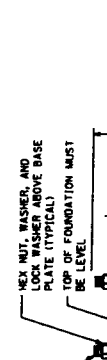

JUNCTION BOX DIMENSIONS (MINIMUM)

	A	B	C	D	E	F
TYPE A	23"	14"	27"	2"	25"	15"
TYPE B	18"	11"	12"	1 1/2"	20"	13"
TYPE C	36"	24"	30"	3"	30"	26"

MINIMUM
NOTES: STACKABLE BORES ARE PERMITTED
JUNCTION BOX

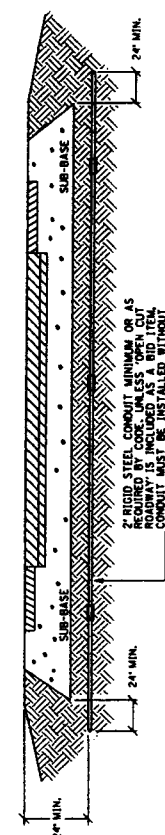
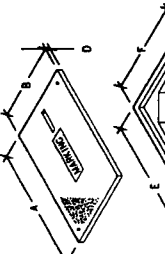

CONDUIT INSTALLATION UNDER EXISTING PAVEMENT DETAIL

DEPTH SHOWN FOR CONDUIT AND WARNING TAPE SHALL BE AS SHOWN. CONTRACTOR SHALL PLACE AND COMPACT BACKFILL IN 6" MAXIMUM LIFTS TO THE SATISFACTION OF THE ENGINEER.

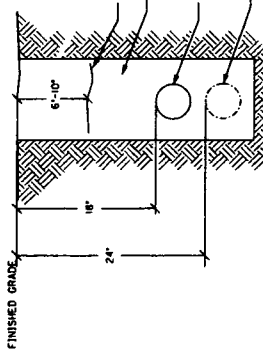

CONDUIT, DUCTED CABLE, AND WARNING TAPE TRENCH

ABOVE GROUND BOX SHALL BE FABRICATED GALVANIZED AFTER FABRICATION. BORES SHALL HAVE NO HOODS/OUTS. COVER SHALL BE WEATHER RESISTANT GASKET AND A MINIMUM 1/2" COVER TO THE BOX. THE PLATE COVER TO THE BOX SHALL BE PROVIDED. CABLE CLAMPS SHALL BE PROVIDED TO SECURE CABLES ENTERING AND EXITING THE BOX.

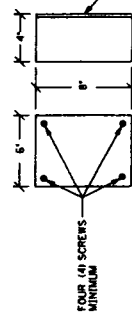

ABOVE GROUND BOX

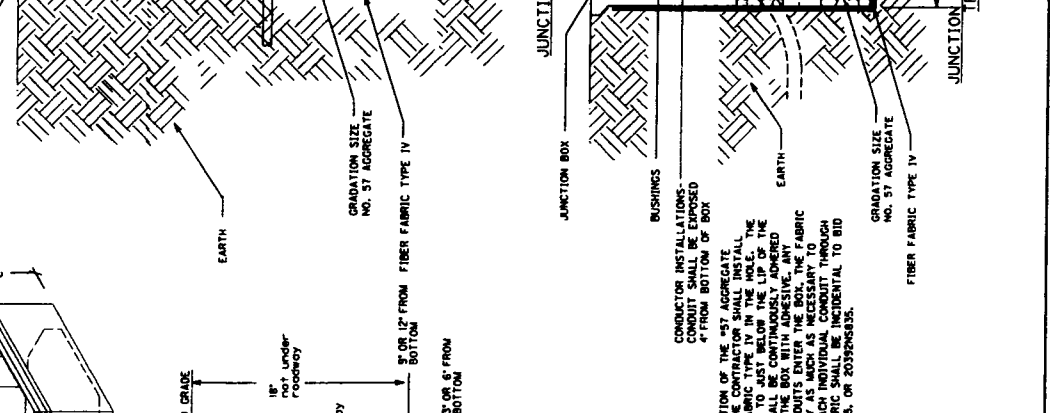
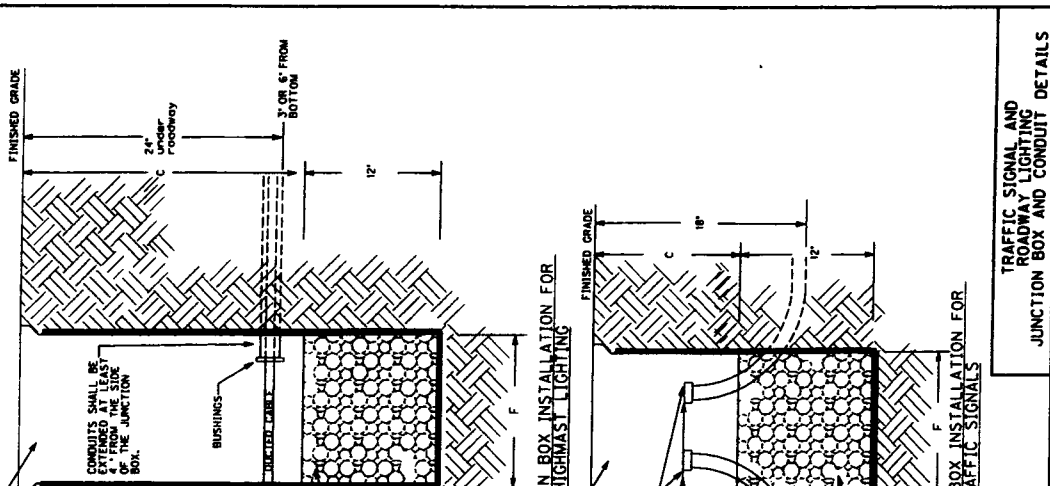
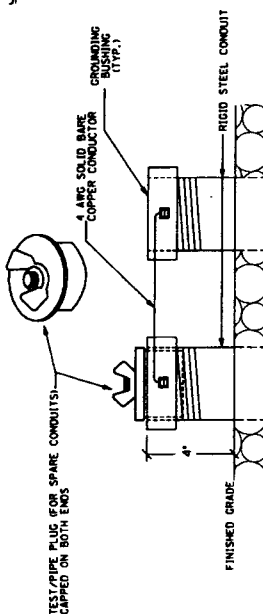

BEFORE THE INSTALLATION OF THE #57 AGGREGATE THE CONTRACTOR SHALL INSTALL GEOTEXTILE FABRIC UNDER THE JUNCTION BOX AND SHALL BE CONTINUOUSLY ADHERED TO THE EXTENSION OF THE BOX WITH ADHESIVE. ANY FABRIC SHALL BE CUT ONLY AS NEEDED TO ALLOW PASSAGE OF EACH INDIVIDUAL CONDUIT THROUGH THE FABRIC. THE FABRIC SHALL BE INCIDENTAL TO BID ITEMS 48H, 203926503, OR 203926503.

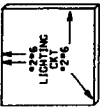

TEST/PIPE PLUG(FOR SPARE CONDUITS) AND GROUNDING DETAIL CONCRETE CABLE MARKERS

COUNTY OF	ITEM NO.	SHEET NO.
FAYETTE	7-3004	18

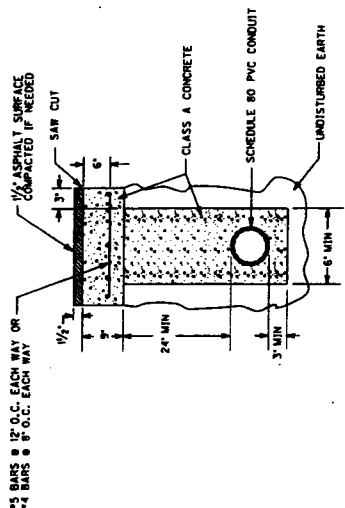

OPEN CUT PAVEMENT DETAIL

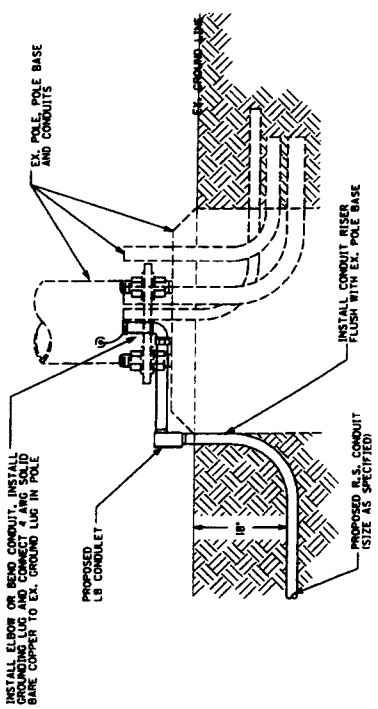

CONDUIT INSTALLATION IN EX. POLE BASE

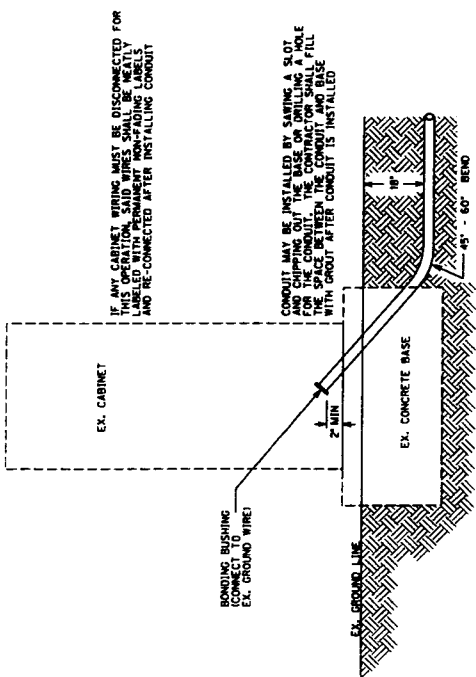

CONDUIT INSTALLATION IN EX. CABINET BASE

IF ANY CABINET WIRES MUST BE DISCONNECTED FOR THIS OPERATION, SAID WIRES SHALL BE NEATLY LABELED WITH PERMANENT NON-FADING LABELS AND RE-CONNECTED AFTER INSTALLING CONDUIT

CONDUIT MAY BE INSTALLED BY SAWING A SLOT AND CHIPPING OUT THE BASE OR DRILLING A HOLE FOR THE CONDUIT. THE CONTRACTOR SHALL FILL THE SPACE WITH GROUT AFTER CONDUIT IS INSTALLED.

3/10/2017

CONDUIT INSTALLATIONS IN EXISTING LOCATIONS

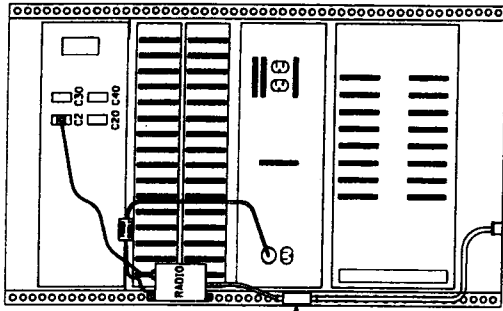

**RADIO INSTALLATION
(REAR OF CABINET)**

Surge protector shall be mounted to cabinet. There shall be no sharp bends in the coaxial cable.

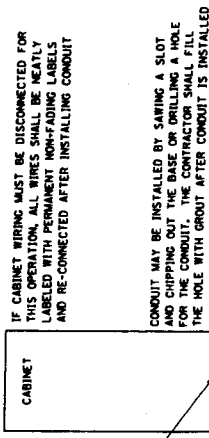

ADDING NEW CONDUIT TO EXISTING BASE

RADIO ANTENNA DETAIL

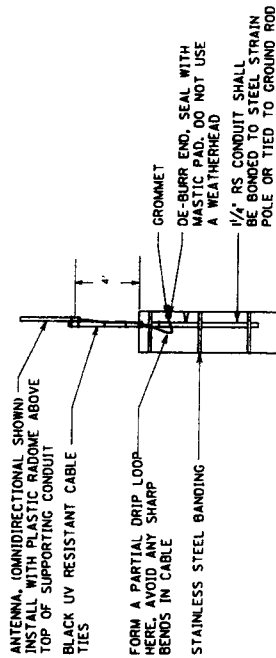

TYPICAL ANTENNA INSTALLATION FOR STEEL AND MAST ARM POLES WITH POLE MOUNT CONTROLLER CABINET

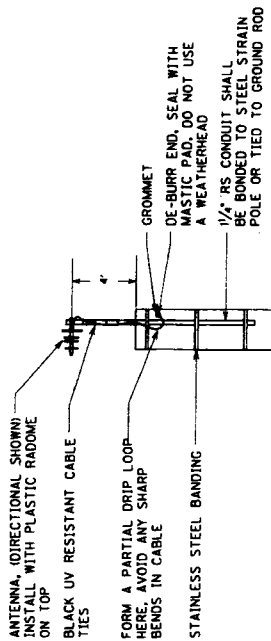

TYPICAL ANTENNA INSTALLATION FOR STEEL AND MAST ARM POLES WITH BASE MOUNT CONTROLLER CABINET

Appendix B

KYTC Approved Traffic Management Plan

KENTUCKY TRANSPORTATION CABINET DEPARTMENT OF HIGHWAYS TRAFFIC MANAGEMENT PLAN

County: FAYETTE Item No.: PO2-628-1600003038

Federal Project No.: 4003-004

Project Description:

Replacement of two signals with mast arm installations and pathway and cable installation within existing RW along Winchester Road (East Seventh Street to Liberty Road). The installation project is to enhance traffic signal communications and coordination.

Roadway Classification: Urban Rural
 Local Collector Arterial Interstate

ADT (current) 31,200 AM Peak Current _____ PM Peak Current _____ % Trucks _____

Project Designation: Significant Other: _____

Traffic Control Plan Design:

Taper and Diversion Design Speeds NA

Minimum Lane Width NA Minimum Shoulder Width NA

Minimum Bridge Width NA

Minimum Radius NA Maximum Grade NA

Minimum Taper Length NA Minimum Intersection Level of Service NA

Existing Traffic Queue Lengths NA Projected Traffic Queue Lengths NA

Comments:

Temporary lane and sidewalk blockages shall be permitted through KYTC and LFUCG Traffic Engineering as appropriate. Permitting requires use of the MUTCD for set up and duration and the local agency broadcasts information on media outlets.

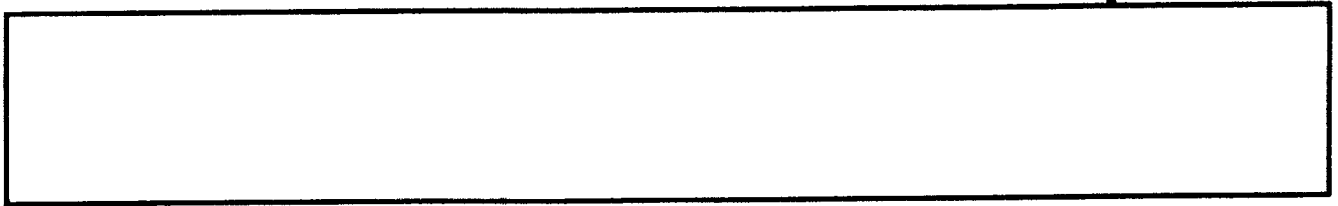

**KENTUCKY TRANSPORTATION CABINET
DEPARTMENT OF HIGHWAYS
TRAFFIC MANAGEMENT PLAN**

Item No. PO2-628-1600003038

Discussion:

1) Public Information Plan	
a) Prepare with assistance from <input type="checkbox"/> KYTC or <input checked="" type="checkbox"/> NA	
b) Identify Trip Generators N/A	f) Railroad Involvement N/A
c) Identify Types of Road Users N/A	g) Address Pedestrians, Bikes Mass Transit N/A
d) Public Information Message N/A	h) Address Timing, Frequency, Updates, Effectiveness of Plan N/A
e) Public Information Strategies to be used N/A	i) Police & Other Emergency Services N/A

**KENTUCKY TRANSPORTATION CABINET
DEPARTMENT OF HIGHWAYS
TRAFFIC MANAGEMENT PLAN**

Item No. PO2-628-1600003038

2) Temporary Traffic Control Plan (For Each Phase of Construction) Phase I	
Exposure Control Measures	Positive Protection Measures
a) Is Road Closure Allowed Type: Temp Lane Blockages	Referenced a) Address Drop Off Protection Criteria N/A
b) Detour Conditions	N/A b) Temporary Barrier Requirements N/A
c) Working Hour Restrictions	Referenced c) Evaluation of Existing Guardrail Conditions N/A
d) Holiday or Special Event Work Restrictions	N/A d) Address Temporary Drainage N/A
e) Evaluation of Intersection LOS	N/A Uniformed Law Enforcement Officers N/A
f) Evaluation of Queue Lengths	N/A Payment for Traffic Control*
g) Evaluation of User Costs and Incentives/Disincentives	N/A a) Method of Project Bidding Referenced
h) Address Pedestrians, Bikes, Mass Transit	N/A b) Special Notes N/A
Work Vehicles and Equipment	N/A *Payment for traffic control items shall be in accordance with the Kentucky Department of Highways Standard Specifications for Road and Bridge Construction
Comments:	
Road closures are not allowed or necessary due to the nature of the project. Most work occurs along the roadside or utility strip. Standard MUTCD compliant set-up is required for all lane closures. Variable message signs shall be required upon request.	
Working hours restricted to non-peak times. Typically 9 a.m. to 3 p.m. and 6 p.m. to 6 a.m. when working in the street.	
Traffic control is incidental to the project.	

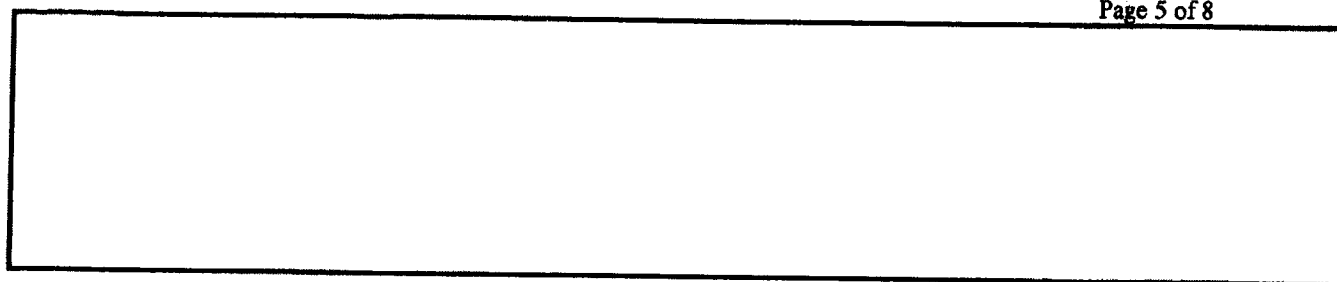

**KENTUCKY TRANSPORTATION CABINET
DEPARTMENT OF HIGHWAYS
TRAFFIC MANAGEMENT PLAN**

Item No. PO2-628-1600003038

2) Temporary Traffic Control Plan (For Each Phase of Construction) Phase	
Exposure Control Measures	Positive Protection Measures
a) Is Road Closure Allowed Type: Referenced	a) Address Drop Off Protection Criteria Referenced
b) Detour Conditions Referenced	b) Temporary Barrier Requirements Referenced
c) Working Hour Restrictions Referenced	c) Evaluation of Existing Guardrail Conditions Referenced
d) Holiday or Special Event Work Restrictions Referenced	d) Address Temporary Drainage Referenced
e) Evaluation of Intersection LOS Referenced	Uniformed Law Enforcement Officers Referenced
f) Evaluation of Queue Lengths Referenced	Payment for Traffic Control*
g) Evaluation of User Costs and Incentives/Disincentives Referenced	a) Method of Project Bidding Referenced
h) Address Pedestrians, Bikes, Mass Transit Referenced	b) Special Notes Referenced
Work Vehicles and Equipment Referenced	*Payment for traffic control items shall be in accordance with the Kentucky Department of Highways Standard Specifications for Road and Bridge Construction
Comments:	

**KENTUCKY TRANSPORTATION CABINET
DEPARTMENT OF HIGHWAYS
TRAFFIC MANAGEMENT PLAN**

Item No. PO2-628-1600003038

**2) Temporary Traffic Control Plan (For Each Phase of Construction)
Phase**

Exposure Control Measures	Positive Protection Measures
a) Is Road Closure Allowed Type: Referenced	a) Address Drop Off Protection Criteria Referenced
b) Detour Conditions Referenced	b) Temporary Barrier Requirements Referenced
c) Working Hour Restrictions Referenced	c) Evaluation of Existing Guardrail Conditions Referenced
d) Holiday or Special Event Work Restrictions Referenced	d) Address Temporary Drainage Referenced
e) Evaluation of Intersection LOS Referenced	Uniformed Law Enforcement Officers Referenced
f) Evaluation of Queue Lengths Referenced	Payment for Traffic Control*
g) Evaluation of User Costs and Incentives/Disincentives Referenced	a) Method of Project Bidding Referenced
h) Address Pedestrians, Bikes, Mass Transit Referenced	b) Special Notes Referenced
Work Vehicles and Equipment Referenced	*Payment for traffic control items shall be in accordance with the Kentucky Department of Highways Standard Specifications for Road and Bridge Construction

Comments:

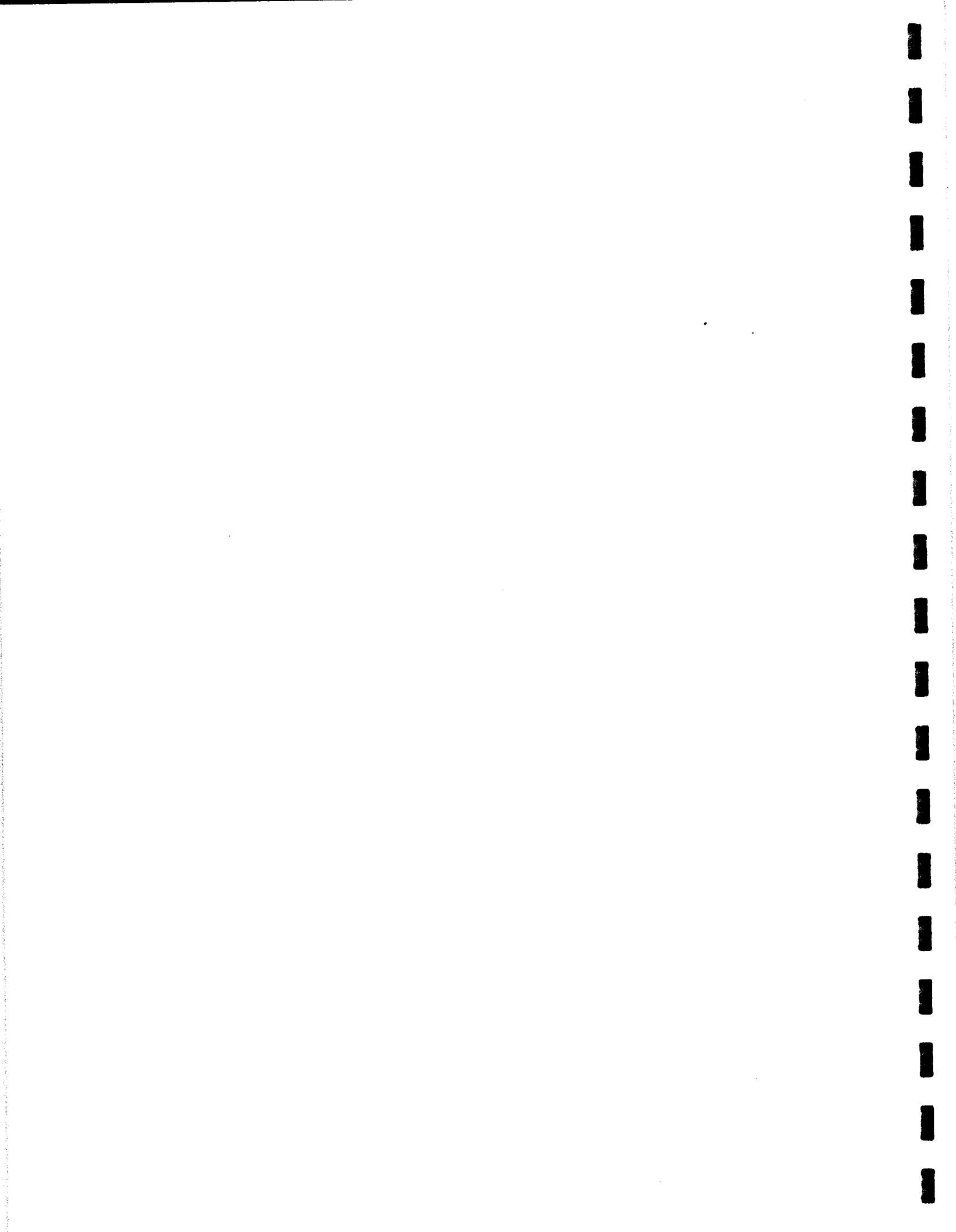

KENTUCKY TRANSPORTATION CABINET
DEPARTMENT OF HIGHWAYS
TRAFFIC MANAGEMENT PLAN

Item No. PO2-628-1600003038

APPROVAL:



Project Manager 10/9/2017
Date



Project Delivery and Preservation Manager 10/12/17
Date
LPA Project Manager

Engineering Support Manager Date

FHWA Representative Date

Revisions to the TMP require review/approval by the signatories.

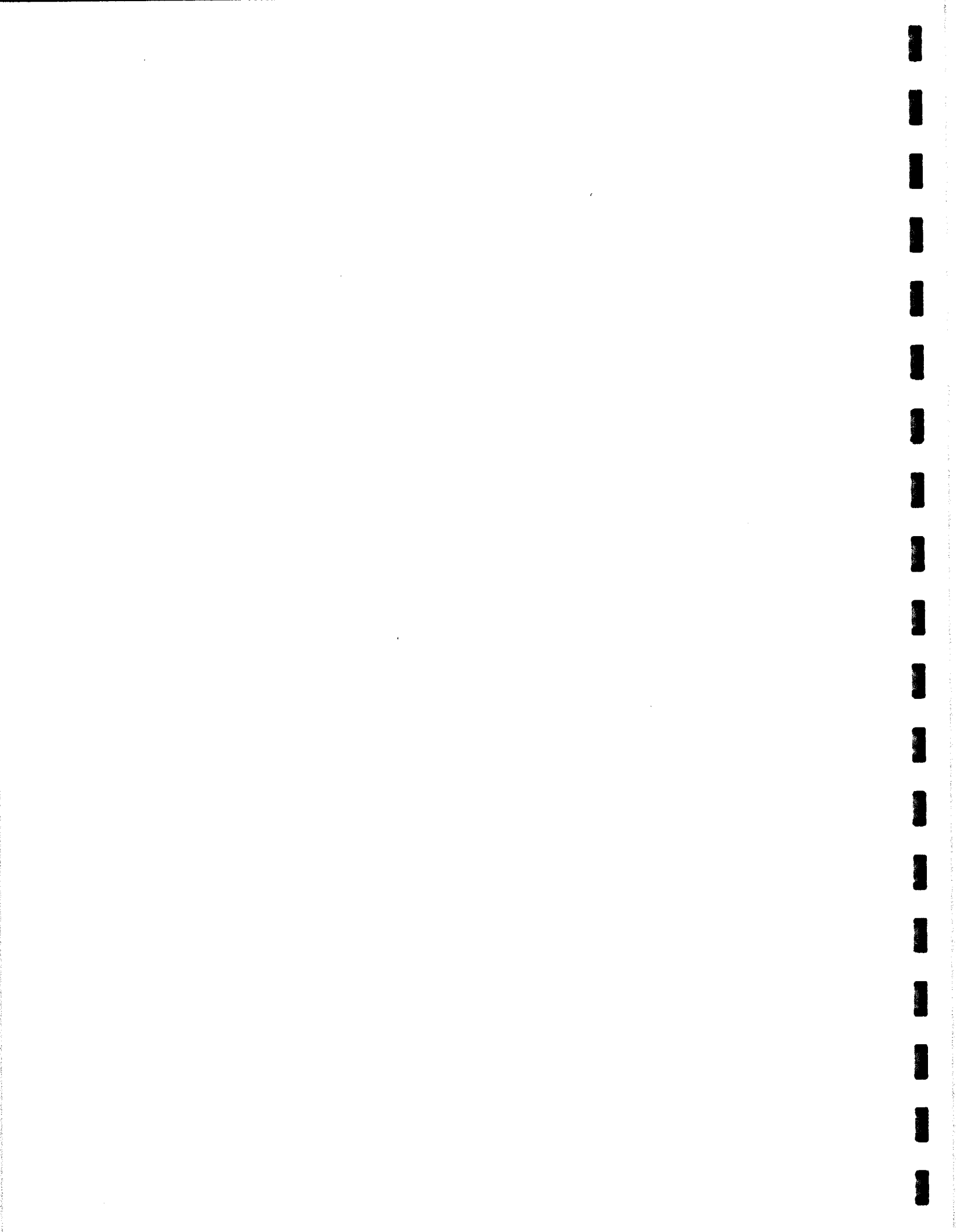

Winchester Road, East Seventh Street,
Liberty Road Intersection Improvements
Lexington, Kentucky

December 2017

APPENDIX C

LOCAL PUBLIC AGENCIES –

SPECIAL PROVISIONS FOR LPA ADMINISTERED PROJECTS

APPENDIX C





Office of Local Programs
Special Provisions for LPA Administered Projects

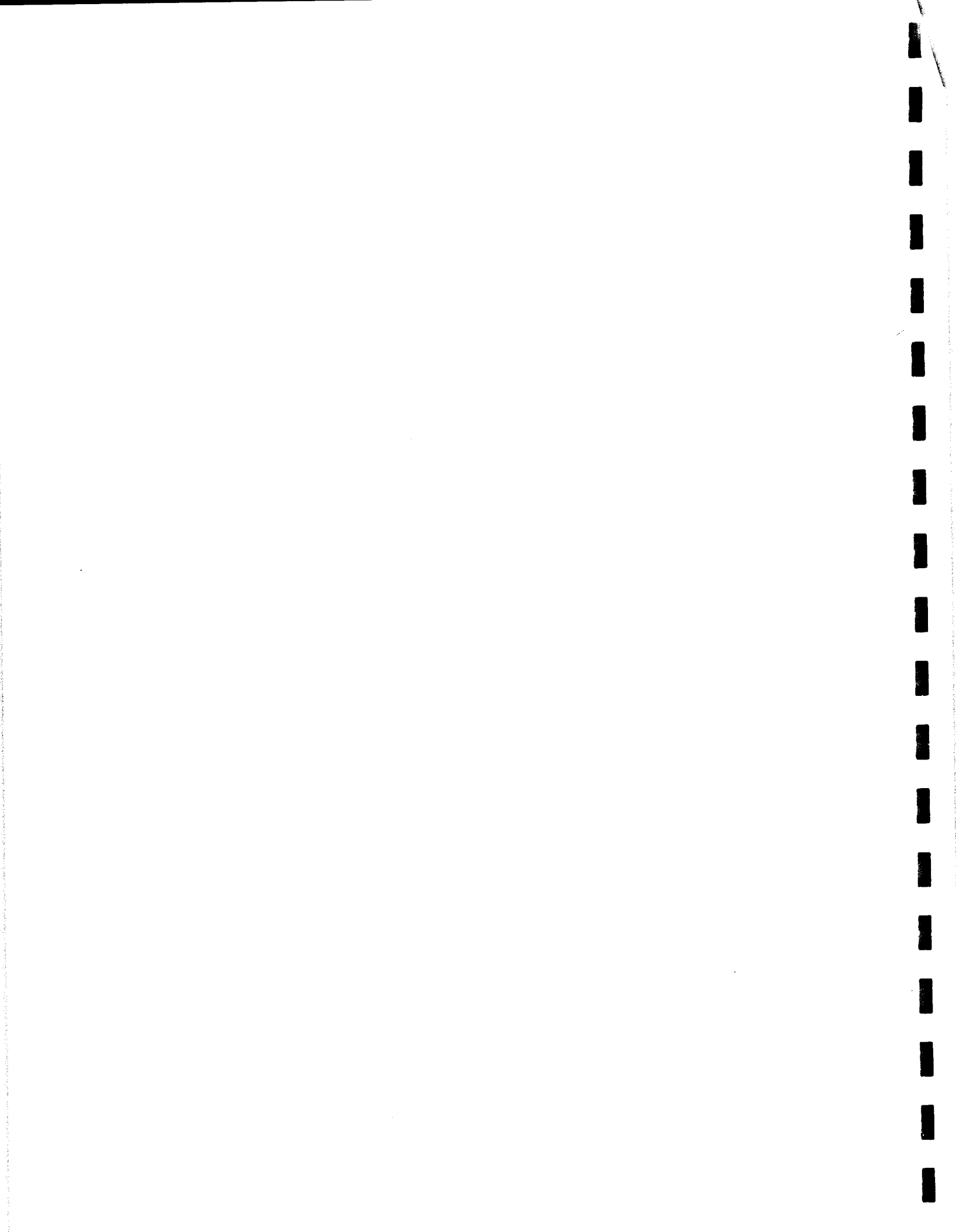

- All contractors and subcontractors must be prequalified by the Kentucky Transportation Cabinet <http://transportation.ky.gov/Professional-Services/Pages/Prequalification-Application-and-Instructions.aspx>
- The Local Public Agency (LPA) will operate in compliance with the Federal Procurement Code, including but not limited to, 23 CFR 635.112 (<https://www.fhwa.dot.gov/legsregs/directives/cfr23toc.htm>)
- This project will follow the Kentucky Standard Specifications for Road and Bridge Construction, 2012 Edition <http://transportation.ky.gov/construction/pages/kentucky-standard-specifications.aspx>
- Title VI of the Civil Rights Act of 1964 prohibits discrimination on the basis of race, color, or national origin in programs and activities receiving Federal financial assistance. Specifically, Title IV provides that “no person in the United States shall, on the ground of race, color, or national origin, be excluded from participation in, be denied the benefit of, or be subjected to discrimination under any program or activity receiving Federal financial assistance” (42 U.S.C. Section 2000d). The Civil Rights Act of 1964 shall be followed in the administration of this project.
- Patented or proprietary materials are discouraged but if they are specified then 23 CFR 635.11 (<https://www.fhwa.dot.gov/legsregs/directives/cfr23toc.htm>) must be followed.
- All Change Orders must be pre-approved by the KYTC. Change order requests must be submitted to the District LPA Coordinator and the OLP Project manager at the same time. All change order requests must be submitted on the LPA-chord (07/02/2010) form
- Failure by a bidder to comply with all applicable sections of the current Kentucky Standards Specifications, including, but not limited to the following, may result in a bid not being considered responsive and thus not eligible to be considered for an award:
 - 102.10 Delivery of Proposals
 - 102.08 Irregular Proposals
 - 102.14 Disqualification of Bidders
 - 102.09 Proposal Guaranty



The following laws, statutes, and regulations must be followed: Federal

- Equal Employment Opportunity Act of 1964
- Rehabilitation Act of 1973
- Age Discrimination Act of 1975
- Americans with Disabilities Act of 1987
- Civil Rights Restoration Act of 1987
- 23 USC 140 (Nondiscrimination)
- 49 CFR 21 (Civil Rights)
- 49 CFR 26 (Disadvantage Business Enterprises)
- 23 CFR 230 (External Programs)
- 23 CFR 633 (Required Contract provisions)
- 23 CFR 635 (Construction and Maintenance)
- Executive Order 11246 (Nondiscrimination)
- 23 USC 106 (Project approval and oversight)
- 23 USC 112 (Letting of contracts)
- 23 USC 113 (Prevailing rate of wage)
- 40 USC 276(a) Davis Bacon Act
- 29 CFR 1 Wage rate determinations
- 29 CFR 3 Weekly statements of payrolls
- 29 CFR 5 Wages
- 29 CFR 6 Wages
- 29 CFR 7 Wages

State

- KRS 45 A Model procurement code
- KRS 176 Department of Highways Procurement
- KRS 136 Corporation and utility taxes
- KRS 139 Sales and use taxes
- KRS 141 Income taxes
- KRS 337 Wage and hours (must have payment bond for wages if less than 5 years in Kentucky)
- KRS 338 OSHA
- KRS 341 Unemployment Compensation
- KRS 342 Workers compensation (must be on file with the Dept. of Workers Claims)
- KAR 603 Prequalification of contractors

Revised 10/01/10

**NOTICE TO ALL BIDDERS
TO REPORT BID RIGGING, BIDDER COLLUSION OR OTHER FRAUDULENT ACTIVITIES**

BID RIGGING, BIDDER COLLUSION OR OTHER FRAUDULENT ACTIVITIES

The U.S. Department of Transportation (USDOT) maintains a Hotline Complaint Center and operates a toll-free "hotline" Monday through Friday, 8:00 a.m. to 5:00 p.m., eastern time. Anyone with knowledge of possible bid rigging, bidder collusion, DBE fraud or other fraudulent activities should use the following hotline number or address to report such activities:

Hotline Number:

(202) 755-1855 or 800-424-9071

Hotline Address:

**Office of Inspector General
P. O. Box 23178 L'Enfant Plaza Station
Washington, D.C. 20024-0178**

The hotline is part of USDOT's continuing effort to identify and investigate highway construction contract fraud and abuse and is operated under the direction of USDOT's Inspector General. All information will be treated confidentially and caller anonymity will be respected.

Revised 10/01/10

**EMPLOYMENT REQUIREMENTS
RELATING TO
NONDISCRIMINATION OF EMPLOYEES
(APPLICABLE TO FEDERAL-AID SYSTEM CONTRACTS)**

**AN ACT OF THE KENTUCKY GENERAL ASSEMBLY
TO PREVENT DISCRIMINATION IN EMPLOYMENT**

**KRS CHAPTER 344
EFFECTIVE JUNE 16, 1972**

The contract on this project, in accordance with KRS Chapter 344, provides that during the performance of this contract, the contractor agrees as follows:

1. The contractor shall not fail or refuse to hire, or shall not discharge any individual, or otherwise discriminate against an individual with respect to his compensation, terms, conditions, or privileges of employment, because of such individual's race, color, religion, national origin, sex, disability or age (between forty and seventy); or limit, segregate, or classify his employees in any way which would deprive or tend to deprive an individual of employment opportunities or otherwise adversely affect his status as an employee, because of such individual's race, color, religion, national origin, sex, disability or age (between forty and seventy). The contractor agrees to post in conspicuous places, available to employees and applicants for employment, notices to be provided setting forth the provisions of this nondiscrimination clause.

2. The contractor shall not print or publish or cause to be printed or published a notice or advertisement relating to employment by such an employer or membership in or any classification or referral for employment by the employment agency, indicating any preference, limitation, specification, or discrimination, based on race, color, religion, national origin, sex, disability or age (between forty and seventy), except that such notice or advertisement may indicate a preference, limitation, or specification based on religion, or national origin when religion, or national origin is a bona fide occupational qualification for employment.

3. If the contractor is in control of apprenticeship or other training or retraining, including on-the-job training programs, he shall not discriminate against an individual because of his race, color, religion, national origin, sex, disability or age (between forty and seventy), in admission to,

or employment in any program established to provide apprenticeship or other training.

4. The contractor will send to each labor union or representative of workers with which he has a collective bargaining agreement or other contract or understanding, a notice to be provided advising the said labor union or workers' representative of the contractor's commitments under this section, and shall post copies of the notice in conspicuous places available to employees and applicants for employment. The contractor will take such action with respect to any subcontract or purchase order as the administering agency may direct as a means of enforcing such provisions, including sanctions for non-compliance.

REVISED: 12-3-92

**NOTICE OF REQUIREMENT FOR AFFIRMATIVE ACTION
TO ENSURE EMPLOYMENT OPPORTUNITY
(Executive Order 11246)**

1. The Offeror's or Bidder's attention is called to the "Equal Opportunity Clause" and the "Standard Federal Equal Employment Specifications" set forth herein.
2. The goals and timetables for minority and female participation, expressed in percentage terms for the Contractor's aggregate work force in each trade on all construction work in the covered area, are as follows:

**GOALS FOR MINORITY
PARTICIPATION
IN EACH TRADE**

**GOALS FOR FEMALE
PARTICIPATION
EACH TRADE**

10.8%

6.9%

These goals are applicable to all Contractor's construction work (whether or not it is Federal or federally-assisted) performed in the covered area. If the contractor performs construction work in a geographical area located outside of the covered area, it shall apply the goals established for such geographical area where the work is actually performed. With regard to this second area, the contractor also is subject to the goals for both its federally involved and non- federally involved construction.

The Contractor's compliance with the Executive Order and the regulations in CFR Part 60-4 shall be based on its implementation of the Equal Opportunity Clause, specific affirmation action obligations required by the specifications set forth in 41 CFR 60-4, 3(a), and its efforts to meet the goals. The hours of minority and female employment and training must be substantially uniform throughout the length of the contract, and in each trade, and the contractor shall make a good faith effort to employ minorities and women evenly on each of its projects. The transfer of minority or female employees or trainees from Contractor to Contractor or from project to project for the sole purpose of meeting the Contractor's goals shall be a violation of the contract, the Executive Order and the regulations in 41 CFR Part 60-4. Compliance with the goals will be measured against the total work hours performed.

3. The Contractor shall provide written notification to the Director of the Office of Federal Contract Compliance Programs within ten (10) working days of award of any construction subcontract in excess of \$10,000.00 at any tier for construction work under the contract resulting from the solicitation. The notification shall list the name, address and telephone number of the subcontractor; employer identification number of the subcontractor; estimated dollar amount of the subcontract; estimated starting and completion dates of the subcontract; and the geographical area in which the subcontract is to be performed. The notification shall be mailed to:

**Evelyn Teague, Regional Director
Office of Federal Contract Compliance Programs
61 Forsyth Street, SW, Suite 7B75
Atlanta, Georgia 30303-8609**

4. As used in this Notice, and in the contract resulting from this solicitation, the "covered area" is Fayette County.

DISTRICT/LOCALITY/MINORITY PERCENTAGE REQUIRED BY COUNTY

DISTRICT	LOCALITY	%	DISTRICT	LOCALITY	%	DISTRICT	LOCALITY	%
8	ADAIR	(2) 7.0%	6	GRANT	(3) 9.2%	9	MASON	(3) 9.2%
3	ALLEN	(1) 12.0%	4	GRAYSON	(3) 9.6%	4	MEADE	(3) 9.6%
7	ANDERSON	(3) 7.0%	1	GRAVES	(1) 5.2%	10	MEWIS	(2) 7.0%
1	BALLARD	(1) 5.2%	4	GREEN	(2) 7.0%	7	MERCER	(3) 7.0%
9	BATH	(3) 7.0%	9	GREENUP	(3) 2.9%	3	METCALFE	(2) 12.0%
3	BAXTER	(2) 12.0%	2	HANCOCK	(1) 3.5%	3	MORROW	(2) 12.0%
11	BELL	(2) 4.5%	4	HARDIN	(3) 9.6%	7	MONTGOMERY	(3) 7.0%
6	BOONE	(4) 11.0%	11	HARLAN	(2) 4.5%	2	MULLENBURG	(1) 3.5%
7	BOURBON	(3) 10.8%	6	HARRISON	(3) 7.0%	10	MORGAN	(2) 7.0%
9	BOYD	(3) 2.9%	4	HART	(2) 9.6%	4	NELSON	(3) 9.6%
7	BOYLE	(3) 7.0%	2	HENDERSON	(1) 4.8%	9	NICHOLAS	(3) 7.0%
6	BRACKEN	(3) 9.2%	5	HENRY	(3) 9.6%	2	OHIO	(1) 3.5%
10	BREATHITT	(2) 7.0%	1	HICKMAN	(1) 5.2%	5	OLDHAM	(3) 11.2%
4	BRECKENRIDGE	(3) 9.6%	2	HOPKINS	(1) 3.5%	6	OWEN	(3) 9.2%
5	BULLITT	(3) 11.2%	11	JACKSON	(2) 7.0%	10	OWSLEY	(2) 7.0%
3	BUTLER	(1) 12.0%	5	JEFFERSON	(3) 11.2%	6	PERMUTON	(4) 9.2%
2	CALDWELL	(1) 5.2%	7	JESSAMINE	(3) 10.8%	10	PERY	(2) 7.0%
1	CALLOWAY	(1) 5.2%	12	JOHNSON	(2) 2.5%	12	PIKE	(2) 2.5%
6	CAMMELL	(4) 11.0%	6	KENTON	(4) 11.0%	10	POWELL	(2) 7.0%
1	CANTON	(1) 5.2%	12	KNOTT	(2) 7.0%	8	PULASKI	(2) 7.0%
6	CARROLL	(3) 9.2%	11	KNOX	(2) 4.5%	6	ROBERTSON	(3) 9.2%
9	CARTER	(3) 2.5%	4	LANDE	(3) 9.6%	8	ROCKCASTLE	(2) 7.0%
8	CASBY	(2) 7.0%	11	LAUREL	(2) 4.5%	9	ROWAN	(3) 2.5%
2	CHRISTIAN	(1) 18.2%	12	LEWIS	(2) 2.5%	8	RUSSELL	(2) 7.0%
7	CLARK	(3) 10.8%	10	LEE	(2) 7.0%	7	SCOTT	(3) 10.8%
11	CLAY	(2) 7.0%	11	LESLIE	(2) 7.0%	5	SHELBY	(3) 9.6%
8	CLINTON	(2) 12.0%	12	LETCHER	(2) 7.0%	3	SIMPSON	(1) 12.0%
1	CRITTENDEN	(1) 5.2%	9	LEWIS	(3) 9.2%	9	SPENCER	(3) 9.6%
8	CUMBERLAND	(2) 12.0%	8	LINCOLN	(2) 7.0%	4	TAYLOR	(2) 7.0%
2	DAVIESS	(1) 4.7%	1	LIVINGSTON	(1) 5.2%	3	TODD	(1) 12.0%
3	EDMONSON	(1) 12.0%	3	LOGAN	(1) 12.0%	1	TRIGG	(1) 12.0%
9	ELLIOTT	(3) 2.5%	1	LYON	(1) 5.2%	5	TRIMBLE	(3) 9.6%
10	ESTILL	(2) 7.0%	1	McCRACKEN	(1) 5.2%	2	UNION	(1) 3.5%
7	FAYETTE	(3) 10.8%	8	McCREARY	(2) 4.5%	3	WARREN	(1) 12.0%
9	FLEMING	(3) 9.2%	2	McLEAN	(1) 3.5%	4	WASHINGTON	(3) 9.6%
12	FLOYD	(2) 2.5%	7	MADISON	(3) 7.0%	8	WAYNE	(2) 4.5%
5	FRANKIE	(3) 7.0%	10	MAGOFFIN	(2) 7.0%	2	WEBSTER	(1) 3.5%
1	FULTON	(1) 5.2%	4	MARION	(3) 9.6%	11	WHITLEY	(2) 4.5%
6	GALLATIN	(3) 9.2%	1	MARSHALL	(1) 5.2%	10	WOLFE	(2) 7.0%
7	GARRARD	(2) 7.0%	12	MARTIN	(2) 2.5%	7	WOODFORD	(3) 10.8%

LOCALITY I (Federal) Kentucky Determination No. CR 85-I-HWY dated 8/15/85 and Federal Decision No. KY 85-1007 dated 10/4/85. (State) Kentucky Determination No. CR 85-I-HWY dated 8/15/85.	LOCALITY II (Federal) Kentucky Determination No. CR 85-II-HWY dated 8/15/85 and Federal Decision No. KY 85-1008 dated 10/4/85. (State) Kentucky Determination No. CR 85-II-HWY dated 8/15/85.	LOCALITY III (Federal) Kentucky Determination No. CR 85-III-HWY dated 8/15/85 and Federal Decision No. KY 85-1009 dated 10/4/85. (State) Kentucky Determination No. CR 85-III-HWY dated 8/15/85.	LOCALITY IV (Federal) Kentucky Determination No. CR 85-IV-HWY dated 8/15/85 and Federal Decision No. KY 85-101 dated 10/4/85. (State) Kentucky Determination No. CR 85-IV-HWY dated 8/15/85.
--	---	--	--

US Department of Labor Final Rule on Federal Executive Order 11246

Discrimination:

Discrimination (because of race, religion, color, national origin, sex, sexual orientation, gender identity, age, or disability) is prohibited. This section applies only to contracts utilizing federal funds, in whole or in part. During the performance of this contract, the contractor agrees as follows:

1. The contractor will not discriminate against any employee or applicant for employment because of race, religion, color, national origin, sex, sexual orientation, gender identity, or age. The contractor further agrees to comply with the provisions of the Americans with Disabilities Act (ADA), Public Law 101-336, and applicable federal regulations relating thereto prohibiting discrimination against otherwise qualified disabled individuals under any program or activity. The contractor agrees to provide, upon request, needed reasonable accommodations. The contractor will take affirmative action to ensure that applicants are employed and that employees are treated during employment without regard to their race, religion, color, national origin, sex, sexual orientation, gender identity, age or disability. Such action shall include, but not be limited to the following; employment, upgrading, demotion or transfer; recruitment or recruitment advertising; layoff or termination; rates of pay or other forms of compensations; and selection for training, including apprenticeship. The contractor agrees to post in conspicuous places, available to employees and applicants for employment, notices setting forth the provisions of this non-discrimination clause.
2. The contractor will, in all solicitations or advertisements for employees placed by or on behalf of the contractor; state that all qualified applicants will receive consideration for employment without regard to race, religion, color, national origin, sex, sexual orientation, gender identity, age or disability.
3. The contractor will send to each labor union or representative of workers with which he has a collective bargaining agreement or other contract or understanding, a notice advising the said labor union or workers' representative of the contractor's commitments under this section, and shall post copies of the notice in conspicuous places available to employees and applicants for employment. The contractor will take such action with respect to any subcontract or purchase order as the administering agency may direct as a means of enforcing such provisions, including sanctions for noncompliance.
4. The contractor will comply with all provisions of Executive Order No. 11246 of September 24, 1965 as amended, and of the rules, regulations and relevant orders of the Secretary of Labor.
5. The contractor will furnish all information and reports required by Executive Order No. 11246 of September 24, 1965, as amended, and by the rules, regulations and orders of the Secretary of

Labor, or pursuant thereto, and will permit access to his books, records and accounts by the administering agency and the Secretary of Labor for purposes of investigation to ascertain compliance with such rules, regulations and orders.

6. In the event of the contractor's noncompliance with the nondiscrimination clauses of this contract or with any of the said rules, regulations or orders, this contract may be cancelled, terminated or suspended in whole or in part and the contractor may be declared ineligible for further government contracts or federally-assisted construction contracts in accordance with procedures authorized in Executive Order No. 11246 of September 24, 1965, as amended, and such other sanctions may be imposed and remedies invoked as provided in or as otherwise provided by law.
7. The contractor will include the provisions of paragraphs (1) through (7) of section 202 of Executive Order 11246 in every subcontract or purchase order unless exempted by rules, regulations or orders of the Secretary of Labor, issued pursuant to section 204 of Executive Order No. 11246 of September 24, 1965, as amended, so that such provisions will be binding upon each subcontractor or vendor. The contractor will take such action with respect to any subcontract or purchase order as the administering agency may direct as a means of enforcing such provisions including sanctions for noncompliance; provided, however, that in the event a contractor becomes involved in, or is threatened with, litigation with a subcontractor or vendor as a result of such direction by the agency, the contractor may request the United States to enter into such litigation to protect the interests of the United States.



Commonwealth of Kentucky
FINANCE AND ADMINISTRATION CABINET
Office of the Controller
Office of Procurement Services
Room 008 Capital Annex
Frankfort, Kentucky 40601
(502) 564-4510
(502) 564-1434 Facsimile

STEVEN L. BESHEAR
Governor

Lori H. Flanery
Secretary

Ed Ross
Executive Director

Don Speer
Executive Director

TO: All Agency Purchasing Contacts

FROM: Donald R. Speer, Executive Director *DRS by JF*
Office of Procurement Services

DATE: April 7, 2015

SUBJECT: US Department of Labor Final Rule on Federal Executive Order 11246

On April 8, 2015, a new federal rule takes effect amending federal Executive Order 11246. This Executive Order, originally signed in 1965, concerns the prohibition of discrimination by contractors and subcontractors where the contract utilizes federal funds. In July, 2014, a new Executive Order was issued to amend EO 11246 by adding sexual orientation and gender identity to the existing categories protected from discrimination in hiring and employment.

For all solicitations issued by a state agency and for all contracts executed or amended on or after April 8, 2015, that utilize federal funds, the following standard boilerplate provisions with new language shall be included:

Discrimination:

Discrimination (because of race, religion, color, national origin, sex, sexual orientation, gender identity, age, or disability) is prohibited. This section applies only to contracts utilizing federal funds, in whole or in part. During the performance of this contract, the contractor agrees as follows:

1. The contractor will not discriminate against any employee or applicant for employment because of race, religion, color, national origin, sex, sexual orientation, gender identity, or age. The contractor further agrees to comply with the provisions of the Americans with Disabilities Act (ADA), Public Law 101-336, and applicable federal regulations relating thereto prohibiting discrimination against otherwise qualified disabled individuals under any program or activity. The contractor agrees to provide, upon request, needed reasonable accommodations. The contractor will take affirmative action to ensure that applicants are employed and that employees are treated during employment without regard to their race, religion, color, national origin, sex, sexual

orientation, gender identity, age or disability. Such action shall include, but not be limited to the following; employment, upgrading, demotion or transfer; recruitment or recruitment advertising; layoff or termination; rates of pay or other forms of compensations; and selection for training, including apprenticeship. The contractor agrees to post in conspicuous places, available to employees and applicants for employment, notices setting forth the provisions of this non-discrimination clause.

2. The contractor will, in all solicitations or advertisements for employees placed by or on behalf of the contractor, state that all qualified applicants will receive consideration for employment without regard to race, religion, color, national origin, sex, sexual orientation, gender identity, age or disability.

3. The contractor will send to each labor union or representative of workers with which he has a collective bargaining agreement or other contract or understanding, a notice advising the said labor union or workers' representative of the contractor's commitments under this section, and shall post copies of the notice in conspicuous places available to employees and applicants for employment. The contractor will take such action with respect to any subcontract or purchase order as the administering agency may direct as a means of enforcing such provisions, including sanctions for noncompliance.

4. The contractor will comply with all provisions of Executive Order No. 11246 of September 24, 1965 as amended, and of the rules, regulations and relevant orders of the Secretary of Labor.

5. The contractor will furnish all information and reports required by Executive Order No. 11246 of September 24, 1965, as amended, and by the rules, regulations and orders of the Secretary of Labor, or pursuant thereto, and will permit access to his books, records and accounts by the administering agency and the Secretary of Labor for purposes of investigation to ascertain compliance with such rules, regulations and orders.

6. In the event of the contractor's noncompliance with the nondiscrimination clauses of this contract or with any of the said rules, regulations or orders, this contract may be cancelled, terminated or suspended in whole or in part and the contractor may be declared ineligible for further government contracts or federally-assisted construction contracts in accordance with procedures authorized in Executive Order No. 11246 of September 24, 1965, as amended, and such other sanctions may be imposed and remedies invoked as provided in or as otherwise provided by law.

7. The contractor will include the provisions of paragraphs (1) through (7) of section 202 of Executive Order 11246 in every subcontract or purchase order unless exempted by rules, regulations or orders of the Secretary of Labor, issued pursuant to section 204 of Executive Order No. 11246 of September 24, 1965, as amended, so that such

April 7, 2015
Page 3 of 3

provisions will be binding upon each subcontractor or vendor. The contractor will take such action with respect to any subcontract or purchase order as the administering agency may direct as a means of enforcing such provisions including sanctions for noncompliance; provided, however, that in the event a contractor becomes involved in, or is threatened with, litigation with a subcontractor or vendor as a result of such direction by the agency, the contractor may request the United States to enter into such litigation to protect the interests of the United States.

Please contact the Office of Procurement Services at 564-4510, if you have any questions.

Standard Title VI/Non-Discrimination Assurances

During the performance of this contract, the contractor, for itself, its assignees, and successors in interest (hereinafter referred to as the "contractor") agrees as follows:

Compliance with Regulations: The contractor (hereinafter includes consultants) will comply with the Acts and the Regulations relative to Non-discrimination in Federally-assisted programs of the U.S. Department of Transportation, **Federal Highway Administration**, as they may be amended from time to time, which are herein incorporated by reference and made a part of this contract.

Non-discrimination: The contractor, with regard to the work performed by it during the contract, will not discriminate on the grounds of race, color, or national origin in the selection and retention of subcontractors, including procurements of materials and leases of equipment. The contractor will not participate directly or indirectly in the discrimination prohibited by the Acts and the Regulations, including employment practices when the contract covers any activity, project, or program set forth in Appendix B of 49 CFR Part 21.

Solicitations for Subcontracts, Including Procurements of Materials and Equipment: In all solicitations, either by competitive bidding, or negotiation made by the contractor for work to be performed under a subcontract, including procurements of materials, or leases of equipment, each potential subcontractor or supplier will be notified by the contractor of the contractor's obligations under this contract and the Acts and the Regulations relative to Non-discrimination on the grounds of race, color, or national origin.

Information and Reports: The contractor will provide all information and reports required by the Acts, the Regulations, and directives issued pursuant thereto and will permit access to its books, records, accounts, other sources of information, and its facilities as may be determined by the Recipient or the **Federal Highway Administration** to be pertinent to ascertain compliance with such Acts, Regulations, and instructions. Where any information required of a contractor is in the exclusive possession of another who fails or refuses to furnish the information, the contractor will so certify to the Recipient or the **Federal Highway Administration**, as appropriate, and will set forth what efforts it has made to obtain the information.

Sanctions for Noncompliance: In the event of a contractor's noncompliance with the Non-discrimination provisions of this contract, the Recipient will impose such contract sanctions as it or the **Federal Highway Administration** may determine to be appropriate, including, but not limited to:

- a. withholding payments to the contractor under the contract until the contractor complies; and/or
- b. cancelling, terminating, or suspending a contract, in whole or in part.

Incorporation of Provisions: The contractor will include the provisions of paragraphs one through six in every subcontract, including procurements of materials and leases of equipment, unless exempt by the Acts, the Regulations and directives issued pursuant thereto. The contractor will take action with respect to any subcontract or procurement as the Recipient or the **Federal Highway Administration** may direct as a means of enforcing such provisions including sanctions for noncompliance. Provided, that if the contractor becomes involved in, or is threatened with litigation by a subcontractor, or supplier because of such direction, the contractor may request the Recipient to enter into any litigation to protect the interests of the Recipient. In addition, the contractor may request the United States to enter into the litigation to protect the interests of the United States.

Standard Title VI/Non-Discrimination Statutes and Authorities

During the performance of this contract, the contractor, for itself, its assignees, and successors in interest (hereinafter referred to as the "contractor") agrees to comply with the following nondiscrimination statutes and authorities; including but not limited to:

- Title VI of the Civil Rights Act of 1964 (42 U.S.C. § 2000d *et seq.*, 78 stat. 252), (prohibits discrimination on the basis of race, color, national origin); and 49 CFR Part 21;
- The Uniform Relocation Assistance and Real Property Acquisition Policies Act of 1970, (42 U.S.C. § 4601), (prohibits unfair treatment of persons displaced or whose property has been acquired because of Federal or Federal-aid programs and projects);
- Federal-Aid Highway Act of 1973, (23 U.S.C. § 324 *et seq.*), (prohibits discrimination on the basis of sex);
- Section 504 of the Rehabilitation Act of 1973, (29 U.S.C. § 794 *et seq.*), as amended, (prohibits discrimination on the basis of disability); and 49 CFR Part 27;
- The Age Discrimination Act of 1975, as amended, (42 U.S.C. § 6101 *et seq.*), (prohibits discrimination on the basis of age);
- Airport and Airway Improvement Act of 1982, (49 USC § 471, Section 47123), as amended, (prohibits discrimination based on race, creed, color, national origin, or sex);
- The Civil Rights Restoration Act of 1987, (PL 100-209), (Broadened the scope, coverage and applicability of Title VI of the Civil Rights Act of 1964, The Age Discrimination Act of 1975 and Section 504 of the Rehabilitation Act of 1973, by expanding the definition of the terms "programs or activities" to include all of the programs or activities of the Federal-aid recipients, sub-recipients and contractors, whether such programs or activities are Federally funded or not);
- Titles II and III of the Americans with Disabilities Act, which prohibit discrimination on the basis of disability in the operation of public entities, public and private transportation systems, places of public accommodation, and certain testing entities (42 U.S.C. §§ 12131 – 12189) as implemented by Department of Transportation regulations at 49 C.F.R. parts 37 and 38;
- The Federal Aviation Administration's Non-discrimination statute (49 U.S.C. § 47123) (prohibits discrimination on the basis of race, color, national origin, and sex);
- Executive Order 12898, Federal Actions to Address Environmental Justice in Minority Populations and Low-Income Populations, which ensures non-discrimination against minority populations by discouraging programs, policies, and activities with disproportionately high and adverse human health or environmental effects on minority and low-income populations;
- Executive Order 13166, Improving Access to Services for Persons with Limited English Proficiency, and resulting agency guidance, national origin discrimination includes discrimination because of limited English proficiency (LEP). To ensure compliance with Title VI, you must take reasonable steps to ensure that LEP persons have meaningful access to your programs (70 Fed. Reg. at 74087 to 74100);
- Title IX of the Education Amendments of 1972, as amended, which prohibits you from discriminating because of sex in education programs or activities (20 U.S.C. 1681 *et seq.*).

**CERTIFICATION REGARDING
KRS 45A.485**

Pursuant to 1994's Senate Bill 258, the bidder/offeror shall reveal to the Commonwealth, prior to the award of a contract, any final determination of a violation by the contractor within the previous five (5) year period of the provisions of KRS Chapter 136, 139, 141, 337, 338, 341 and 342.

For the purpose of complying with the provisions of Senate Bill 258, please list any final determination(s) of violations(s) of KRS Chapters 136, 139, 141, 337, 338, 341, and 342, which have been rendered against the bidder or offeror within the five (5) years preceding the award of this contract. Please include, the date of the determination the state agency issuing the determination. (Please use extra sheets if necessary.)

KRS VIOLATION	DATE	STATE AGENCY
---------------	------	--------------

The contractor is further notified that 1994's Senate Bill 258 requires that for the duration of this contract, the contractor shall be in continuous compliance with the provisions of KRS Chapters 136, 139, 141, 337, 338, 341 and 342, which apply to the contractor's operations. Senate Bill 258, further provides that the contractor's failure to reveal a final determination of a violation of KRS Chapters 136, 139, 141, 337, 338, 341 and 342, or failure to comply with the above-cited statues for the duration of the contact, shall be grounds for the Commonwealth's cancellation of the contract, and the contractor's disqualification from eligibility to bid or submit proposals to the Commonwealth for a period of two (2) years.

RISK MANAGEMENT PROVISIONS INSURANCE AND INDEMNIFICATION

1.0 DEFINITIONS.

The CONTRACTOR understands and agrees that the Risk Management Provisions of this Contract define the responsibilities of the CONTRACTOR to the OWNER.

As used in these Risk Management Provisions, the terms "CONTRACTOR" and "OWNER" shall be defined as follows:

- a. "CONTRACTOR" means the contractor and its employees, agents, servants, owners, principals, licensees, assigns and subcontractors of any tier.
- b. "OWNER" means the Lexington-Fayette Urban County Government and its elected and appointed officials, employees, agents, boards, consultants, assigns, volunteers and successors in interest.

2.0 INDEMNIFICATION AND HOLD HARMLESS PROVISION

CONTRACTOR shall defend, indemnify, and hold harmless OWNER from and against all liability, claims, losses, actions, costs, expenses, obligations, fines, and assessments of whatever kind, including defense costs and attorney's fees, that are in any way incidental to or connected with, or that arise or are alleged to have arisen, directly or indirectly, in whole or in part, from or by: (a) CONTRACTOR's negligent acts or intentional misconduct, or errors or omissions, in connection with the performance of this contract, (b) CONTRACTOR's performance or breach of the contract provided the claim or loss is attributable to death, illness, personal injury, or property loss or damage or loss of use, and not caused by OWNER, or (c) the condition of any premises, equipment or other property being used or operated by the CONTRACTOR in connection with the performance of this contract. In the event OWNER is alleged to be liable based upon the actions or inactions of CONTRACTOR, CONTRACTOR shall defend such allegations and shall bear all costs, fees and expenses of such defense, including but not limited to, all attorneys' fees and expenses, court costs, and expert witness fees and expenses, using attorneys approved in writing by OWNER, which approval shall not be unreasonably withheld. This Indemnification and Hold Harmless Provision shall in no way be limited by any financial responsibility or insurance requirements, and shall survive the termination of this contract.

3.0 FINANCIAL RESPONSIBILITY

The CONTRACTOR understands and agrees that it shall, prior to final acceptance of its bid and the commencement of any work, demonstrate the ability to assure compliance with the Indemnity Agreement and other provisions of this Contract.

4.0 INSURANCE REQUIREMENTS

BIDDERS' ATTENTION IS DIRECTED TO THE INSURANCE REQUIREMENTS BELOW, AS BIDDERS MUST CONFER WITH THEIR RESPECTIVE INSURANCE AGENTS, BROKERS, OR CARRIERS TO DETERMINE IN ADVANCE OF BID SUBMISSION THE AVAILABILITY OF THE INSURANCE COVERAGES AND ENDORSEMENTS REQUIRED HEREIN. IF AN APPARENT LOW BIDDER FAILS TO COMPLY STRICTLY WITH THE INSURANCE REQUIREMENTS BELOW, THAT BIDDER MAY BE DISQUALIFIED FROM AWARD OF THE CONTRACT.

4.1 Required Insurance Coverage

CONTRACTOR shall procure and maintain for the duration of this contract the following or equivalent insurance policies at no less than the limits shown below and cause its subconsultants to maintain similar insurance with limits acceptable to OWNER in order to protect OWNER against claims for injuries to persons or damages to property which may arise from or in connection with the performance of the work hereunder by CONTRACTOR. The cost of such insurance shall be included in any bid:

Coverage Limits

General Liability \$1 million per occurrence, \$2 million aggregate

(Insurance Services Office Form CG 00 01) or \$2 million combined single limit Commercial Automobile Liability combined single, \$1 million per occurrence (Insurance Services Office Form CA 0001)

Worker's Compensation Statutory

Employer's Liability \$1,000,000.00

The policies above shall contain the following conditions:

- a. OWNER shall be named as an additional insured in the General Liability Policy and Commercial Automobile Liability Policy.
- b. The General Liability Policy shall be primary to any insurance or self-insurance retained by OWNER.
- c. The General Liability Policy shall include a Products and Completed Operations endorsement or Premises and Operations Liability endorsement unless it is deemed not to apply by OWNER.
- d. OWNER shall be provided at least 30 days advance written notice via certified mail, return receipt requested, in the event any of the required policies are canceled or non-renewed.
- e. Said coverage shall be written by insurers acceptable to OWNER and shall be in a form acceptable to OWNER.

Insurance placed with insurers with a rating classification of no less than Excellent (A or A-) and a financial size category of no less than VIII, as defined by the most current Best's Key Rating Guide shall be deemed automatically acceptable.

4.2. Additional insurance coverage and amounts required, if any, are stated below: NONE

4.3. Renewals

After insurance has been approved by OWNER, evidence of renewal of an expiring policy must be submitted to OWNER, and may be submitted on a manually signed renewal endorsement form. If the policy or carrier has changed, however, new evidence of coverage must be submitted in accordance with these Insurance Requirements.

4.4. Deductibles and Self-Insured Programs

IF CONTRACTOR INTENDS TO SUBMIT SELF-INSURANCE PLAN FOR BID, THIS MUST BE FORWARDED TO LEXINGTON-FAYETTE URBAN COUNTY GOVERNMENT, DIVISION OF RISK MANAGEMENT, 200 EAST MAIN STREET, LEXINGTON, KENTUCKY 40507 NO LATER THAN A MINIMUM OF FIVE (5) WORKING DAYS PRIOR TO BID OPENING DATE. Self-insurance programs, deductibles, and self-insured retentions in insurance policies are subject to separate approval by Lexington-Fayette Urban County Government's Division of Risk Management, upon review of evidence of CONTRACTOR'S financial capacity to respond to claims. Any such programs or retentions must provide OWNER with at least the same protection from liability and defense of suits as would be afforded by first-dollar insurance coverage. If CONTRACTOR satisfies any portion of the insurance requirements through deductibles, self-insurance programs, or self-insured retentions, CONTRACTOR agrees to provide Lexington-Fayette Urban County Government, Division of Risk Management, the following data prior to the final acceptance of bid and the commencement of any work:

- a. CONTRACTOR'S latest audited financial statement, including auditor's notes.
 - b. Any records of any self-insured trust fund plan or policy and related accounting statements.
 - c. Actuarial funding reports or retained losses.
 - d. CONTRACTOR'S Risk Management Manual or a description of CONTRACTOR'S self-insurance and risk management program.
 - e. A claim loss run summary for the previous five (5) years.
 - f. Self-Insured Associations will be considered.
- 4.5. **Verification of Coverage**
Prior to award of bid, CONTRACTOR agrees to furnish OWNER with all applicable Certificates of Insurance signed by a person authorized by the insurer to bind coverage on its behalf. If requested, CONTRACTOR shall provide OWNER copies of all insurance policies, including all endorsements.
- 4.6. **Right to Review, Audit and Inspect**

CONTRACTOR understands and agrees that OWNER may review, audit and inspect any and all of CONTRACTOR'S records and operations to insure compliance with these Insurance Requirements.

5.0 SAFETY AND LOSS CONTROL

5.1. CONTRACTOR agrees to adhere to and comply with William-Steiger Act, enacted December 1970, and all other federal, state and local safety and environmental laws, regulations and ordinances. The CONTRACTOR shall provide all safeguards, safety devices and protective equipment, and take any other action necessary to protect the life, health and safety and property of all persons on the job site, the public and the owner.

5.2. The current Kentucky Occupational Safety and Health Standards of the Construction Industry 29 CFR Part 1926 adopted by 803 KAR 2:030 and the Kentucky Occupational Safety and Health Standard for General Industry 29 CFR Part 1910 as adopted by KAR 2:010, and as promulgated by the Kentucky Occupational Safety and Health Standards Board and as amended or modified, are hereby incorporated into and made an integral part of the Contract with full compliance the responsibility solely of the CONTRACTOR.

5.3. The CONTRACTOR understands and agrees that the OWNER shall be permitted, but not obligated, to inspect the work place, operations, machinery and equipment involved in this Contract and review and audit any and all CONTRACTOR'S records and documents as deemed necessary by the OWNER to assure compliance with any and all of the provisions of this Contract and maximize the protection of the OWNER. Safety on the job, however, remains solely the responsibility of the CONTRACTOR.

6.0 DEFINITION OF DEFAULT

CONTRACTOR understands and agrees that the failure to comply with any of these insurance, safety, or loss control provisions shall constitute default under this Contract. CONTRACTOR also agrees that OWNER may elect at its option any single remedy or penalty or any combination of remedies and penalties, as available, including but not limited to purchasing insurance and charging CONTRACTOR for any such insurance premiums purchased, or suspending or terminating this Contract.

635.410 Buy America requirements.

- (a) The provisions of this section shall prevail and be given precedence over any requirements of this subpart which are contrary to this section. However, nothing in this section shall be construed to be contrary to the requirements of §635.409(a) of this subpart.
- (b) No Federal-aid highway construction project is to be authorized for advertisement or otherwise authorized to proceed unless at least one of the following requirements is met:
- (1) The project either: (i) Includes no permanently incorporated steel or iron materials, or
 - (ii) if steel or iron materials are to be used, all manufacturing processes, including application of a coating, for these materials must occur in the United States. Coating includes all processes which protect or enhance the value of the material to which the coating is applied.
 - (2) The State has standard contract provisions that require the use of domestic materials and products, including steel and iron materials, to the same or greater extent as the provisions set forth in this section.
 - (3) The State elects to include alternate bid provisions for foreign and domestic steel and iron materials which comply with the following requirements. Any procedure for obtaining alternate bids based on furnishing foreign steel and iron materials which is acceptable to the Division Administrator may be used. The contract provisions must (i) require all bidders to submit a bid based on furnishing domestic steel and iron materials, and (ii) clearly state that the contract will be awarded to the bidder who submits the lowest total bid based on furnishing domestic steel and iron materials unless such total bid exceeds the lowest total bid based on furnishing foreign steel and iron materials by more than 25 percent.
 - (4) When steel and iron materials are used in a project, the requirements of this section do not prevent a minimal use of foreign steel and iron materials, if the cost of such materials used does not exceed one-tenth of one percent (0.1 percent) of the total contract cost or \$2,500, whichever is greater. For purposes of this paragraph, the cost is that shown to be the value of the steel and iron products as they are delivered to the project.
- (c) (1) A State may request a waiver of the provisions of this section if;
- (i) The application of those provisions would be inconsistent with the public interest; or
 - (ii) Steel and iron materials/products are not produced in the United States in sufficient and reasonably available quantities which are of a satisfactory quality.
- (2) A request for waiver, accompanied by supporting information, must be submitted in writing to the Regional Federal Highway Administrator (RFHWA) through the FHWA Division Administrator. A request must be submitted sufficiently in advance of the need for the waiver in order to allow time for proper review and action on the request. The RFHWA will have approval authority on the request.
 - (3) Requests for waivers may be made for specific projects, or for certain materials or products in specific geographic areas, or for combinations of both, depending on the circumstances.
 - (4) The denial of the request by the RFHWA may be appealed by the State to the Federal Highway Administrator (Administrator), whose action on the request shall be considered administratively final.
 - (5) A request for a waiver which involves nationwide public interest or availability issues or more than one FHWA region may be submitted by the RFHWA to the Administrator for action.
 - (6) A request for waiver and an appeal from a denial of a request must include facts and justification to support the granting of the waiver. The FHWA response to a request or appeal will be in writing and made available to the public upon request. Any request for a nationwide waiver and FHWA's action on such a request may be published in the Federal Register for public comment.
 - (7) In determining whether the waivers described in paragraph (c)(1) of this section will be granted, the FHWA will

consider all appropriate factors including, but not limited to, cost, administrative burden, and delay that would be imposed if the provision were not waived.

(d) Standard State and Federal-aid contract procedures may be used to assure compliance with the requirements of this section.

[48 FR 53104, Nov. 25, 1983, as amended at 49 FR 18821, May 3, 1984; 58 FR 3

§ 635.109 Standardized changed condition clauses.

(a) Except as provided in paragraph (b) of this section, the following changed conditions contract clauses shall be made part of, and incorporated in, each highway construction project approved under 23 U.S.C. 106:

(1) *Differing site conditions.* (i) During the progress of the work, if subsurface or latent physical conditions are encountered at the site differing materially from those indicated in the contract or if unknown physical conditions of an unusual nature, differing materially from those ordinarily encountered and generally recognized as inherent in the work provided for in the contract, are encountered at the site, the party discovering such conditions shall promptly notify the other party in writing of the specific differing conditions before the site is disturbed and before the affected work is performed.

(ii) Upon written notification, the engineer will investigate the conditions, and if it is determined that the conditions materially differ and cause an increase or decrease in the cost or time required for the performance of any work under the contract, an adjustment, excluding anticipated profits, will be made and the contract modified in writing accordingly. The engineer will notify the contractor of the determination whether or not an adjustment of the contract is warranted.

(iii) No contract adjustment which results in a benefit to the contractor will be allowed unless the contractor has provided the required written notice.

(iv) No contract adjustment will be allowed under this clause for any effects caused on unchanged work. (This provision may be omitted by the STD's at their option.)

(2) *Suspensions of work ordered by the engineer.* (i) If the performance of all or any portion of the work is suspended or delayed by the engineer in writing for an unreasonable period of time (not originally anticipated, customary, or inherent to the construction industry) and the contractor believes that additional compensation and/or contract time is due as a result of such suspension or delay, the contractor shall submit to the engineer in writing a request for adjustment within 7 calendar days of receipt of the notice to resume work. The request shall set forth the reasons and support for such adjustment.

(ii) Upon receipt, the engineer will evaluate the contractor's request. If the engineer agrees that the cost and/or time required for the performance of the contract has increased as a result of such suspension and the suspension was caused by conditions beyond the control of and not the fault of the contractor, its suppliers, or subcontractors at any approved tier, and not caused by weather, the engineer will make an adjustment (excluding profit) and modify the contract in writing accordingly. The contractor will be notified of the engineer's determination whether or not an adjustment of the contract is warranted.

(iii) No contract adjustment will be allowed unless the contractor has submitted the request for adjustment within the time prescribed.

(iv) No contract adjustment will be allowed under this clause to the extent that performance would have been suspended or delayed by any other cause, or for which an adjustment is provided or excluded under any other term or condition of this contract.

(3) *Significant changes in the character of work.* (i) The engineer reserves the right to make, in writing, at any time during the work, such changes in quantities and such alterations in the work as are necessary to satisfactorily complete the project. Such changes in quantities and alterations shall not invalidate the contract nor release the surety, and the contractor agrees to perform the work as altered.

(ii) If the alterations or changes in quantities significantly change the character of the work under the contract, whether such alterations or changes are in themselves significant changes to the character of the work or by affecting other work cause such other work to become significantly different in character, an adjustment, excluding anticipated profit, will be made to the contract. The basis for the adjustment shall be agreed upon prior to the performance of the work. If a basis cannot be agreed upon, then an adjustment will be made either for or against the contractor in such amount as the engineer may determine to be fair and equitable.

(iii) If the alterations or changes in quantities do not significantly change the character of the work to be performed under the contract, the altered work will be paid for as provided elsewhere in the contract.

(iv) The term "significant change" shall be construed to apply only to the following circumstances:

(A) When the character of the work as altered differs materially in kind or nature from that involved or included in the original proposed construction; or

(B) When a major item of work, as defined elsewhere in the contract, is increased in excess of 125 percent or decreased below 75 percent of the original contract quantity. Any allowance for an increase in quantity shall apply only to that portion in excess of 125 percent of original contract item quantity, or in case of a decrease below 75 percent, to the actual amount of work performed. (b) The provisions of this section shall be governed by the following:

(1) Where State statute does not permit one or more of the contract clauses included in paragraph (a) of this section, the State statute shall prevail and such clause or clauses need not be made applicable to Federal-aid highway contracts.

(2) Where the State transportation department has developed and implemented one or more of the contract clauses included in paragraph (a) of this section, such clause or clauses, as developed by the State transportation department may be included in Federal-aid highway contracts in lieu of the corresponding clause or clauses in paragraph (a) of this section. The State's action must be pursuant to a specific State statute requiring differing contract conditions clauses. Such State developed clause or clauses, however, must be in conformance with 23 U.S.C., 23 CFR and other applicable Federal statutes and regulations as appropriate and shall be subject to the Division Administrator's approval as part of the PS&E. (c) In the case of a design-build project, STDs are strongly encouraged to use "suspensions of work ordered by the engineer" clauses, and may consider "differing site condition" clauses and "significant changes in the character of work" clauses which are appropriate for the risk and responsibilities that are shared with the design-builder.

1
2
3
4
5
6
7
8
9
10
11
12
13
14
15
16
17
18
19
20
21
22
23
24
25

MAST ARM DESIGN ANALYSIS

Salsa Design Analysis (Detail Version)

I. Project Data

Project Num:	Pole 1	Author:	Created:
District:	7	Neal, Jeff (jneal@lexingtonky.gov)	12/8/2016 9:32:00 AM
County:	Fayette	PM Name:	File Name:
City:	Lexington	Permit Num:	Winchester@7th-Liberty_1 ext
		Code Version:	Last Edited:
		AASHTO 6th Edition (2013)	7/13/2017 1:3:00 PM
			Department:

II. Design Assumptions

Ice Load Pressure:	3.00	Gust Effect:	1.14
Velocity Conversion:	0.93	Basic Wind Speed:	90.00
		Wind Importance:	0.87

III. Mast Arm

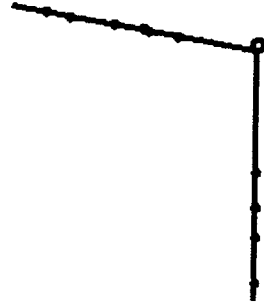

Pole A

Disclaimer: The contents of this program were developed for use by Florence and Hutcheson, Inc. The calculations derived from said program should not be used for any application without examination and verification of its accuracy and suitability for such application by professionally qualified personnel. Florence and Hutcheson, Inc. assumes no liability or responsibility for and makes no representations or warranties as to the applicability or suitability of these results and anyone making use thereof or relying thereon assumes all risk and liability arising from such use or reliance. This program does not constitute a standard, specification or regulation.

Salsa Design Analysis (Detail Version)

IV. Pole Inputs

Pole	Name	Height (ft)	Align (deg)	Length (in)	Width (in)	Thickness (in)	Weight (lbs)	Drag
A	72" x 24" x 18" Street Sign	15.00	180.00	24.00	72.00	18.00	100.00	1.12

Pole	Name	Length (ft)	Height (ft)	Align (deg)	Type	Length (in)	Width (in)	Thickness (in)	Weight (lbs)	Drag	Distance (ft)
A	3 Section w/ BP	43.0	20.0	80.0	Signal	59.0	24.0	16.0	50.0	1.2	14.0
A	72" x 24" x 18" Street Sign	43.0	20.0	80.0	Sign	24.0	72.0	18.0	100.0	1.1	19.0
A	Video Camera	43.0	20.0	80.0	Other	10.0	10.0	10.0	15.0	1.2	20.0
A	3 Section w/ BP	43.0	20.0	180.0	Signal	59.0	24.0	16.0	50.0	1.2	21.0
A	3 Section w/ BP	43.0	20.0	80.0	Signal	59.0	24.0	16.0	50.0	1.2	25.0
A	Video Camera	43.0	20.0	180.0	Other	10.0	10.0	10.0	15.0	1.2	27.0
A	3 Section w/ BP	43.0	20.0	180.0	Signal	59.0	24.0	16.0	50.0	1.2	32.0
A	30" x 36" Sign	43.0	20.0	80.0	Sign	36.0	36.0	6.0	16.0	1.1	38.0
A	3 Section w/ BP	43.0	20.0	80.0	Signal	59.0	24.0	16.0	50.0	1.2	37.0
A	30" x 36" Sign	43.0	20.0	180.0	Sign	36.0	36.0	6.0	16.0	1.1	40.0

Pole	Height (ft)	Base (in)	Top (in)	Thickness (in)	Cd
A	22.00	18.50	15.49	0.37	0.79

Length (ft)	Height (ft)	Seg1 Length (ft)	Seg1 Base (in)	Seg1 Taper	Seg1 Thickness (in)	Seg2 Length (ft)	Seg2 Base (in)	Seg2 Taper	Seg2 Thickness (in)	Seg1 Length (ft)	Seg1 Base (in)	Seg1 Taper	Seg1 Thickness (in)	Seg2 Length (ft)	Seg2 Base (in)	Seg2 Taper	Seg2 Thickness (in)
43.0000	20.0000	N/A	14.5000	0.1400	0.2500	N/A	0.1400	N/A	0.1400	N/A	N/A	N/A	0.1400	N/A	N/A	N/A	N/A

Salsa Design Analysis (Detail Version)

Length (ft)	Height (ft)	Seg1 Length (ft)	Seg1 Base (in)	Seg1 Taper	Seg1 Thickness (in)	Seg2 Base (in)	Seg2 Taper	Seg2 Thickness (in)
43.0000	20.0000	N/A	14.5000	0.1400	0.2500	N/A	0.1400	N/A

VII. Pole Results

Pole A	Axial (lb)	Shear (lb)	Calculated Moment (k-ft)	Torsion (k-ft)
Group I	4,542.12	0.00	36.92	0.00
Group II	4,542.12	2,818.29	85.93	8.67
Group III	6,304.71	1,844.40	87.88	4.97

VIII. Design Summary

Pole Number	Max Axial (lb)	Max Shear (lb)	Calculated Moment (k-ft)	Torsion (k-ft)
A	6,304.71	2,818.29	87.88	8.67

Pole Number	Diameter (inches)	Soil (feet)	Level Ground			2:1 Ground Slope			Vertical Bars			Ties or Spiral	
			Volume (CY)	Rock (feet)	Volume (CY)	Volume (CY)	Rock (feet)	Volume (CY)	Size	Total	Size	Pitch	
A	36.0	14.0	3.7	6.0	1.6	17.00	4.5	6.00	1.6	#8	13	#4	12.00

Salsa Design Analysis (Detail Version)

I. Project Data

Project Num:	Pole 3
District:	7
County:	Fayette
City:	Lexington

Author:	Neal, Jeff (jneal@lexingtonky.gov)
PM Name:	S. Foster
Permit Num:	
Code Version:	MSHTO 6th Edition (2013)

Created:	1/7/2017 8:27:00 PM
File Name:	Winchester@7th-Liberty_3ext
Last Edited:	7/21/2017 10:50:00 AM
Department:	

II. Design Assumptions

Ice Load Pressure:	3.00
Velocity Conversion:	0.93

Gust Effect:	1.14
Basic Wind Speed:	90.00

Wind Importance:	0.87
------------------	------

III. Mast Arm

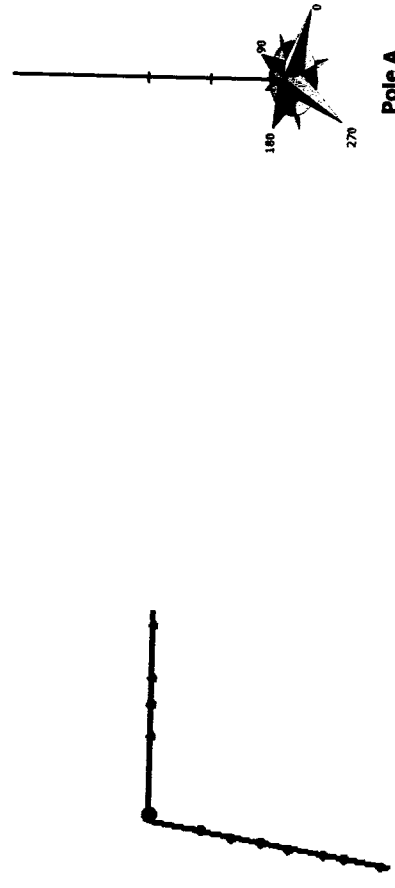

Pole A

Disclaimer: The contents of this program were developed for use by Florence and Hutcheson, Inc. The calculations derived from said program should not be used for any application without examination and verification of its accuracy and suitability for such application by professionally qualified personnel. Florence and Hutcheson, Inc. assumes no liability or responsibility for and makes no representations or warranties as to the applicability or suitability of these results and anyone making use thereof or relying thereon assumes all risk and liability arising from such use or reliance. This program does not constitute a standard, specification or regulation.

Salsa Design Analysis (Detail Version)

IV. Pole Inputs

Pole	Name	Height (ft)	Align (deg)	Length (in)	Width (in)	Thickness (in)	Weight (lbs)	Drag
A	Pedestrian Signal	8.00	260.00	16.00	16.00	18.00	25.00	1.12
A	Pedestrian Signal	8.00	0.00	16.00	16.00	18.00	25.00	1.12
A	72" x 24" x 18" Street Sign	15.00	260.00	24.00	72.00	18.00	100.00	1.12
A	72" x 24" x 18" Street Sign	15.00	0.00	24.00	72.00	18.00	100.00	1.12

Pole	Name	Length (ft)	Height (ft)	Align (deg)	Type	Length (in)	Width (in)	Thickness (in)	Weight (lbs)	Drag	Distance (ft)
A	Luminaires	10.0	30.0	260.0	Other	10.0	10.0	10.0	50.0	0.5	10.0
A	3 Section w/ BP	40.0	20.0	0.0	Signal	59.0	24.0	16.0	50.0	1.2	16.0
A	3 Section w/ BP	47.0	20.0	260.0	Signal	59.0	24.0	16.0	50.0	1.2	16.0
A	Video Camera	40.0	20.0	0.0	Other	16.0	16.0	10.0	15.0	1.2	22.0
A	Video Camera	47.0	20.0	260.0	Other	10.0	10.0	10.0	15.0	1.2	22.0
A	3 Section w/ BP	47.0	20.0	260.0	Signal	59.0	24.0	16.0	50.0	1.2	27.0
A	3 Section w/ BP	40.0	20.0	0.0	Signal	59.0	24.0	16.0	50.0	1.2	27.0
A	30" x 36" Sign	47.0	20.0	260.0	Sign	36.0	30.0	0.0	16.0	1.1	34.0
A	30" x 36" Sign	40.0	20.0	0.0	Sign	36.0	30.0	0.0	16.0	1.1	37.0
A	3 Section w/ BP	47.0	20.0	260.0	Signal	59.0	24.0	16.0	50.0	1.2	38.0
A	30" x 36" Sign	47.0	20.0	260.0	Sign	36.0	30.0	0.0	16.0	1.1	45.0

Pole	Height (ft)	Base (in)	Top (in)	Thickness (in)	Cd
A	30.00	19.00	15.99	0.37	0.79

Salsa Design Analysis (Detail Version)

Length (ft)	Height (ft)	Seg1 Length (ft)	Seg1 Base (in)	Seg1 Taper	Seg1 Thickness (in)	Seg2 Base (in)	Seg2 Taper	Seg2 Thickness (in)	Length (ft)	Height (ft)	Seg1 Length (ft)	Seg1 Base (in)	Seg1 Taper	Seg1 Thickness (in)	Seg2 Base (in)	Seg2 Taper	Seg2 Thickness (in)
40.0000	20.0000	N/A	14.5000	0.1400	0.2500	N/A	0.1400	N/A	10.0000	30.0000	N/A	9.0000	0.1400	0.1800	N/A	0.1400	N/A
47.0000	20.0000	20.0000	16.2500	0.1400	0.3700	14.1600	0.1400	0.1700									

VII. Pole Results

Pole A	Axial (lb)	Shear (lb)	Calculated Moment (k-ft)	Torsion (k-ft)
Group I	5,779.64	0.00	40.88	0.00
Group II	5,779.64	3,386.20	98.87	20.27
Group III	7,904.85	2,248.10	100.94	12.37

VIII. Design Summary

Pole Number	Max Axial (lb)	Max Shear (lb)	Calculated Moment (k-ft)	Torsion (k-ft)
A	7,904.85	3,386.20	100.94	20.27

Pole Number	Diameter (inches)	Level Ground				2:1 Ground Slope				Vertical Bars			Ties or Spiral	
		Soil (feet)	Volume (CY)	Rock (feet)	Volume (CY)	Soil (feet)	Volume (CY)	Rock (feet)	Volume (CY)	Size	Total	Size	Pitch	
A	36.0	16.0	4.2	6.0	1.6	18.00	4.7	6.00	1.6	#8	13	#4	12.00	

Salsa Design Analysis (Detail Version)

Salsa Design Analysis (Detail Version)

I. Project Data

Project Num:	Corner 5	Author:	Neal, Jeff (jneal@lexingtonky.gov)	Created:	3/2/2017 10:01:00 AM
District:	7	PM Name:	S. Palmer	File Name:	Winchester@7th-Liberty_5 ext
County:	Fayette	Permit Num:	AASHTO 6th Edition (2012)	Last Edited:	7/13/2017 12:21:00 PM
City:	Lexington	Code Version:		Department:	

II. Design Assumptions

Ice Load Pressure:	3.00	Gust Effect:	1.14	Wind Importance:	0.87
Velocity Conversion:	0.93	Basic Wind Speed:	90.00		

III. Mast Arm



Disclaimer: The contents of this program were developed for use by Florence and Hutcheson, Inc. The calculations derived from said program should not be used for any application without examination and verification of its accuracy and suitability for such application by professionally qualified personnel. Florence and Hutcheson, Inc. assumes no liability or responsibility for and makes no representations or warranties as to the applicability or suitability of these results and anyone making use thereof or relying thereon assumes all risk and liability arising from such use or reliance. This program does not constitute a standard, specification or regulation.

Salsa Design Analysis (Detail Version)

IV. Pole Inputs

Pole	Name	Height (ft)	Align (deg)	Length (in)	Width (in)	Thickness (in)	Weight (lbs)	Drag
A	72" x 24" x 18" Street Sign	15.00	0.00	24.00	72.00	18.00	100.00	1.12
A	72" x 24" x 18" Street Sign	15.00	260.00	24.00	72.00	18.00	100.00	1.12

Pole	Name	Length (ft)	Height (ft)	Align (deg)	Type	Length (in)	Width (in)	Thickness (in)	Weight (lbs)	Drag	Distance (ft)
A	3 Section w/ BP	35.0	20.0	0.0	Signal	59.0	24.0	16.0	50.0	1.2	5.0
A	Luminaires	10.0	30.0	260.0	Other	10.0	10.0	16.0	50.0	0.5	10.0
A	3 Section w/ BP	35.0	20.0	0.0	Signal	59.0	24.0	16.0	50.0	1.2	16.0
A	3 Section w/ BP	70.0	20.0	260.0	Signal	59.0	24.0	16.0	50.0	1.2	16.0
A	Video Camera	70.0	20.0	260.0	Other	10.0	10.0	10.0	15.0	1.2	22.0
A	Video Camera	35.0	20.0	0.0	Other	10.0	10.0	16.0	15.0	1.2	22.0
A	3 Section w/ BP	70.0	20.0	260.0	Signal	59.0	24.0	16.0	50.0	1.2	27.0
A	30" x 36" Sign	35.0	20.0	0.0	Sign	36.0	30.0	0.0	16.0	1.1	33.0
A	30" x 36" Sign	70.0	20.0	260.0	Sign	36.0	30.0	0.0	16.0	1.1	35.0
A	4 Section w/ BP	70.0	20.0	260.0	Signal	73.0	24.0	16.0	50.0	1.2	39.0
A	3 Section w/ BP	70.0	20.0	260.0	Signal	59.0	24.0	16.0	50.0	1.2	49.0
A	30" x 36" Sign	70.0	20.0	260.0	Sign	36.0	30.0	0.0	16.0	1.1	55.0
A	Video Camera	70.0	20.0	260.0	Other	10.0	10.0	10.0	15.0	1.2	55.0
A	3 Section w/ BP	70.0	20.0	260.0	Signal	59.0	24.0	16.0	50.0	1.2	60.0
A	30" x 36" Sign	70.0	20.0	260.0	Sign	36.0	30.0	0.0	16.0	1.1	66.0

Pole	Height (ft)	Base (in)	Top (in)	Thickness (in)	Cd
A	30.00	20.50	17.49	0.37	0.79

Salsa Design Analysis (Detail Version)

Length (ft)	Height (ft)	Seg1 Length (ft)	Seg1 Base (in)	Seg1 Taper	Seg1 Thickness (in)	Seg2 Base (in)	Seg2 Taper	Seg2 Thickness (in)	Length (ft)	Height (ft)	Seg1 Length (ft)	Seg1 Base (in)	Seg1 Taper	Seg1 Thickness (in)	Seg2 Base (in)	Seg2 Taper	Seg2 Thickness (in)
35.0000	20.0000	N/A	13.7500	0.1400	0.2500	N/A	0.1400	N/A	10.0000	30.0000	N/A	9.0000	0.1400	0.1800	N/A	0.1400	N/A
70.0000	20.0000	40.0000	18.5000	0.1400	0.3700	13.8100	0.1400	0.1800									

VII. Pole Results

Pole A	Axial (lb)	Shear (lb)	Calculated Moment (k-ft)	Torsion (k-ft)
Group I	7,210.04	0.00	91.65	0.00
Group II	7,210.04	3,672.63	159.97	-10.90
Group III	9,796.59	2,413.64	185.36	-7.18

VIII. Design Summary

Pole Number	Max Axial (lb)	Max Shear (lb)	Calculated Moment (k-ft)	Torsion (k-ft)
A	9,796.59	3,672.63	185.36	-7.18

Pole Number	Diameter (inches)	Level Ground			2:1 Ground Slope			Vertical Bars			Ties or Spiral		
		Soil (feet)	Volume (CY)	Rock (feet)	Soil (feet)	Volume (CY)	Rock (feet)	Volume (CY)	Size	Total	Size	Pitch	
A	36.0	18.0	4.7	6.0	1.6	21.00	5.5	6.00	1.6	#8	13	#4	12.00

Salsa Design Analysis (Detail Version)

