

# PROMASK 25

## FACEPIECE

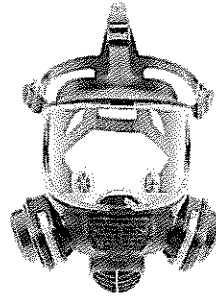

### Promask 25 Facepiece with Rubber Head Harness

Part Number	Description	Pieces Per Pkg	Price
013024	Polycarbonate Lens, Reg	1	\$145.00
013027	Polycarbonate Lens, Small	1	\$145.00

### Promask 25 Facepiece with Polyester Head Harness

Part Number	Description	Pieces Per Pkg	Price
013023	Polycarbonate Lens, Reg	1	\$143.00
013028	Polycarbonate Lens, Small	1	\$143.00

### Promask 25 Facepiece Lens Kits Accessories

Part Number	Description	Pieces Per Pkg	Price
012798	Standard Eyeglass Kit		\$20.80
200373-52F	52mm Wire Frame Eyeglass Kit		\$122.40
200373-60F	60mm Wire Frame Eyeglass Kit		\$122.40

## Promask 25 Facepiece Parts & Accessories

Item Number	Description	Pieces Per Pkg	Part Number	Price
1	Speech Diaphragm Assembly Kit	1	012778	\$15.10
2	Exhalation Valve Cover	1	012688	\$8.01
3	Exhalation Valve Disc	1	013374	\$9.20
4	Nosecup Valve Seats	2	012773	\$5.41
5	Valve Discs	4	012774	\$11.86
6	Nosecup with Fastening Ring	1	012776	\$37.30
7	Head Harness, EPDM (less buckles)	1	012692	\$30.16
8	Head Harness, Poly (less buckles) (not shown)	1	012775	\$30.16
9	Visor Frame Set (Top, Bottom, 2 Screws)	1	012693	\$12.48
10	Harness Buckles	5	012694	\$8.63
11	Visor	1	012695	\$32.66
17	Speech Channel Cover Kit	1	012779	\$15.00
Not shown	Protective Lens Covers	10	012698	\$32.66
Not shown	Fleece Facepiece Bag	1	805534-01	\$26.00

# Promask 25 Facepiece

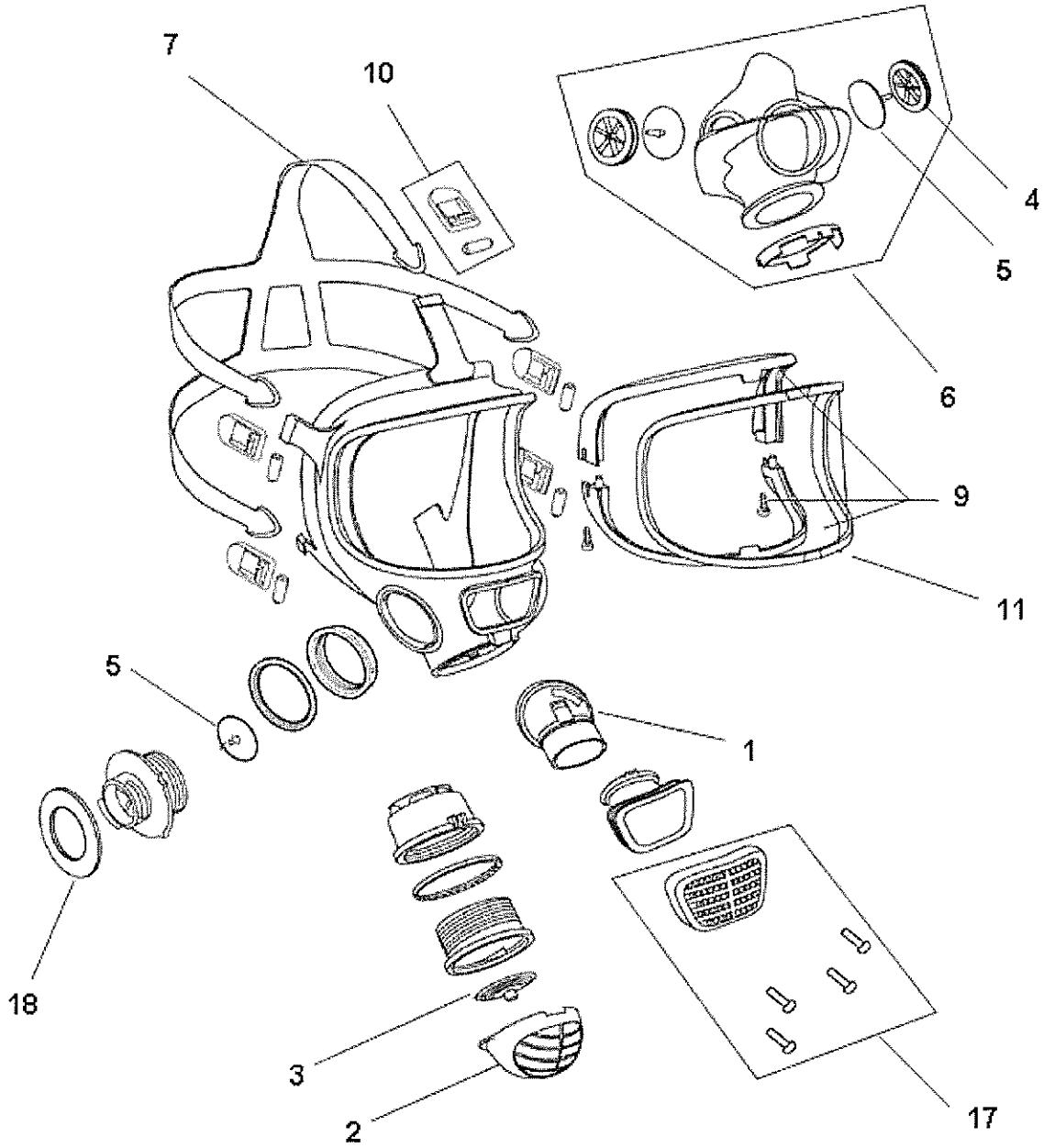

## M110

### CBRN DUAL LENS FACEPIECE

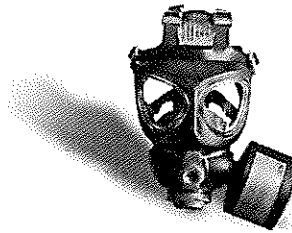

#### M110 CBRN Dual Lens Facepiece

Part Number	Description	Price
013262	Medium/Large ☺	\$266.00
013282	Medium/Large with Drinking Device ☺	\$296.40
013242	Small ☺	\$266.00
013222	Small with Drinking Device ☺	\$296.40

#### Canister

Part Number	Description	Price
045135	CBRN CAP 1 Canister ☺	\$53.10
805557-01	MPC Plus Cartridge	\$23.00
052683	P100 Cartridge	\$11.30
045123	Enforcement Cartridge	\$35.40

#### Accessories

Part Number	Description	Price
200374-54F	54mm Wire Split-Frame Eyeglass Kit	\$122.40
012593	Drinking Bottle	\$29.12
012592	Speech Diaphragm	\$6.76
10011882	Tactical Facepiece Bag with Belt Mounting	\$76.50
10012151	Shoulder Strap for Tactical Facepiece Bag	\$21.10
10012152	Leg Strap for Tactical Facepiece Bag	\$12.80
805534-01	Fleece Facepiece Bag	\$26.00

#### Replacement Parts

Part Number	Description	Pieces Per Pkg	Price
012577	Exhalation valve set assembly	1	\$7.28
012774	Inhalation valve discs, set of four (4)	4	\$11.86
013372	Inhalation valve seats, set of two (2)	2	\$9.80
012574	Nose cup for regular M110	1	\$39.52
012575	Nose cup for small M110	1	\$39.52
012773	Nose cup valve seats, set of two (2)	2	\$5.41
012598	Head harness	1	\$30.16
012592	Speech diaphragm plug	8	\$6.76
012594	Mouthpiece, drinking device (if equipped)	1	\$6.55
012597	Lid, drinking device (if equipped)	10	\$7.59



CBRN approved when used with Cap 1 Canister



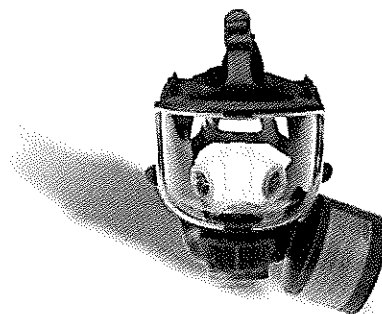

# M120

## CBRN FACEPIECE



### M120 CBRN Facepiece

Part Number	Description	Price
013013	Medium/Large 	\$266.00
013014	Small 	\$266.00

### Canister

Part Number	Description	Price
045135	CBRN CAP 1 Canister 	\$53.10
805557-01	MPC Plus Cartridge	\$23.00
052683	P100 Cartridge	\$11.30
045123	Enforcement Cartridge	\$35.40

### Accessories

Part Number	Description	Price
012798	Standard Eyeglass Kit	\$20.80
1001882	Tactical Facepiece Bag with Belt Mounting	\$76.50
10012151	Shoulder Strap for Tactical Facepiece Bag	\$21.10
10012152	Leg Strap for Tactical Facepiece Bag	\$12.80
805534-01	Fleece Facepiece Bag	\$26.00

### Replacement Parts

Part Number	Description	Price
012577	Exhalation Valve Set Assembly	\$7.28
013372	Inhalation Valve Seats (EPDM), Set of two (2)	\$9.80
012773	Nosecup Valve Seats, set of two (2)	\$5.41
012774	Valve Discs, set of four (4)	\$11.86
012776	Nosecup w/Fastening Ring	\$37.30
012692	Head harness (ribbed)	\$30.16
013377	40mm Plug	\$3.10
012694	Harness Buckles, set of five (5)	\$8.63



The M120 Facepiece is NIOSH CBRN APR approved with the CBRN Cap-1 canister, and with the C420 Plus CBRN PAPR as configured on page 70

## XCEL HALFMASK

### ASSEMBLIES

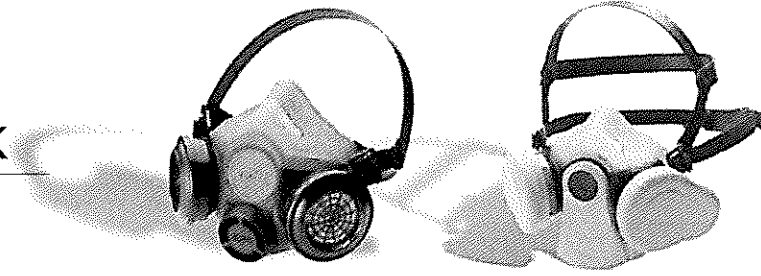

Select part numbers from this product line are part of the Scott Fast Trax Program. Contact your Regional Manager or Scott Customer Service for more details.

### Xcel Half-Mask Assembly

Part Number	Description	Pieces Per Pkg	Price
7421-111	Xcel Halfmask, Small	1	\$32.00
7421-112	Xcel Halfmask, Small/Medium	1	\$32.00
7421-113	Xcel Halfmask, Medium/Large	1	\$32.00
7421-114	Xcel Halfmask, Large	1	\$32.00
7421-111V	Xcel Halfmask with Voicemitter, Small	1	\$39.00
7421-112V	Xcel Halfmask with Voicemitter, Small/Medium	1	\$39.00
7421-113V	Xcel Halfmask with Voicemitter, Medium/Large	1	\$39.00
7421-114V	Xcel Halfmask with Voicemitter, Large	1	\$39.00
7421-411V	Xcel HS Halfmask, Small, with Voicemitter	1	\$39.00
7421-412V	Xcel HS Halfmask, Small/Medium, with Voicemitter	1	\$39.00
7421-413V	Xcel HS Halfmask, Medium/Large, with Voicemitter	1	\$39.00
7421-414V	Xcel HS Halfmask, Large, with Voicemitter	1	\$39.00
7421-511V	Xcel HS Halfmask, Small (Case of 20), with Voicemitter	1	\$759.00
7421-512V	Xcel HS Halfmask, Small/Medium (Case of 20), with Voicemitter	1	\$759.00
7421-513V	Xcel HS Halfmask, Medium/Large (Case of 20), with Voicemitter	1	\$759.00
7421-514V	Xcel HS Halfmask, Large (Case of 20), with Voicemitter	1	\$759.00

### Accessories

Part Number	Description	Pieces Per Pkg	Price
7422-FT1	Quantitative Fit Test Adapter Kit	1	\$45.90
7421-PF1	Xcel Halfmask, Probed, Small	1	\$49.50
7421-PF2	Xcel Halfmask, Probed, Small/Medium	1	\$49.50
7421-PF3	Xcel Halfmask, Probed, Medium/Large	1	\$49.50
7421-PF4	Xcel Halfmask, Probed, Large	1	\$49.50
200915-01	Filter Covers for 742 Series P100, Pair	1	\$8.10
200915-70	Filter Covers for 742 Series P100, 70 Pair	1	\$528.40

Replacement Parts

Item Number	Description	Pieces Per Plg	Part Number	Price
2	Inhalation Valve (Set of 4)	4	200211-01	\$12.70
3	Exhalation Valve	1	13870-00	\$6.50
4	Exhalation Valve Cover	10	10011094	\$1.90
6-8	Head Harness Assembly	1	7420-108	\$9.40
7	Head Harness Clip	10	10011095	\$1.40
8	Head Harness D-Ring	10	10011096	\$1.40

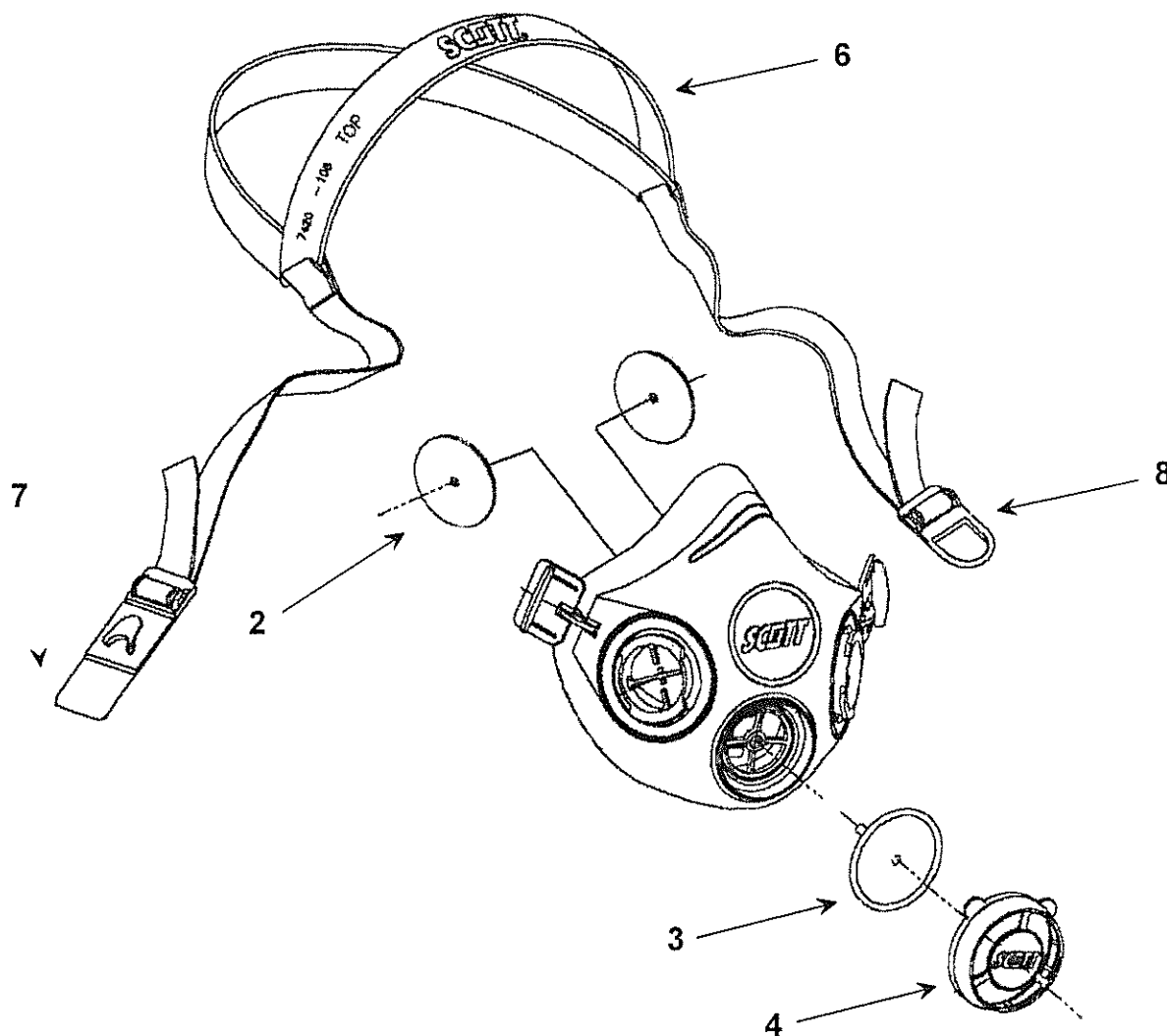

## PROFLOW 3

### POWERED AIR PURIFYING RESPIRATOR



#### Proflo 3 Powered Air Purifying Respirator (PAPR)

Part Number	Description	Price
805820-01	Proflo 3 PAPR blower unit with nylon waistbelt integrated rechargeable battery, and single unit charger (Breathing tube not included)	\$1,073.30

#### Proflo 3 Powered Air Purifying Respirator Breathing Tubes

Part Number	Description	Price
31001207	Breathing Tube (36") for hoods	\$54.10

#### Proflo 3 Powered Air Purifying Respirator Hoods

Part Number	Description	Price
200676-01	FH22 double bib hood (each)	\$49.40
200676-03	FH22 double bib hood (3/pack)	\$140.80
31001429	FH2 hood (each)	\$47.00

#### Proflo 3 Powered Air Purifying Cartridges and Canisters

Part Number	Description	Price
045170	MPC40PF Cartridge	\$25.60
045123	Enforcement cartridge	\$35.40
052683	P100/HEPA cartridge	\$11.30

#### Proflo 3 Powered Air Purifying Respirator Accessories

Part Number	Description	Price
063791	Spare single charger	\$168.50
063748	Proflo 3 Battery, Rechargeable, NIMH	\$183.10
064072	Nylon textile waistbelt	\$21.60
064074	Smooth PVC belt	\$24.00
200677-03	Hose Shrouds (3/pack)	\$35.10
2016236	Support Washer (5/pack)	\$9.40
2017491	Lock Nut (5/pack)	\$9.70

# PROFLOW 2

## POWERED AIR PURIFYING RESPIRATOR

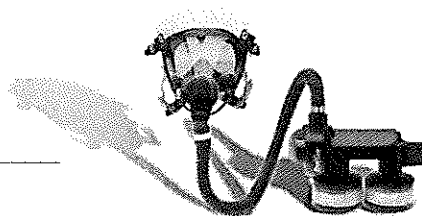

### Proflow 2 Powered Air Purifying Respirator (PAPR)

	Blower + Rechargeable Battery	Nylon Textile Belt	31" Breathing Tube	Charger	Facepiece Adapter (For use with AV Series Facepieces)	Price
Part Number	064081	064072	064077	063791	805059-01	
064087	●	●	●			\$857.00
805810-03	●	●	●	●		\$993.00
805810-01	●	●	●	●	●	\$1,001.00

\*\* Facepiece adapter is needed if using AV-style facepieces; not needed if using M120 facepiece.

### Proflow 2 Powered Air Purifying Respirator Breathing Tubes

Part Number	Description	Price
064077	Breathing tube (for facepieces), standard 31 inch	\$47.50
064079	Breathing tube (for facepieces) extra long 39 inch	\$47.50

### Proflow 2 Powered Air Purifying Respirator Facepieces

Part Number	Description	Price
See Page 51	AV-3000 Series	
See Page 55	AV-2000	
See page 65	M120	
See page 64	M110	
See page 58	Weld-O-Vista	

### Proflow 2 Powered Air Purifying Cartridges and Canisters

Part Number	Description	Price
045123	Enforcement cartridge	\$35.40
052683	P100/HEPA cartridge	\$11.30
045170	MPC40PF Cartridge	\$25.60

### Proflow 2 Powered Air Purifying Respirator Accessories

Part Number	Description	Price
063791	Spare single charger	\$168.50
063548	Proflow Battery, Rechargeable, NIMH	\$168.50
064072	Nylon textile waistbelt	\$21.60
064074	Smooth PVC belt	\$24.00
31000578	Scott duffel bag carry case	\$43.90
805059-01	40mm adapter for AV Series facepieces	\$43.70

## C420 PLUS

POWERED AIR PURIFYING RESPIRATOR

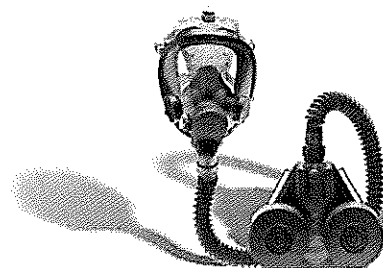

### C420 Plus

	Blower	LiSO2 Battery	Devon Belt	30' CBRN Breathing Tube (use with M120)	36' CBRN Breathing Tube (use with M120)	30' CBRN AV-PAPR Hose (use with AV-Facepieces*)	36' CBRN AV-PAPR Hose (use with AV-Facepieces*)	Price
Part No:	200699-01	805358-01	805359-01	200700-30	200700-36	200829-30	200829-36	

### C420 Plus PAPR Blowers:

200699-01	●							\$1,006.80
200698-00	●		●					\$1,063.90

### C420 CBRN\*\* PAPR Kits: ☺

*For use with M120 Facepiece (sold separately)*

200698-30	●		●	●				\$1,137.30
200698-36	●		●		●			\$1,137.30
200710-30	●	●	●	●				\$1,234.20
200710-36	●	●	●		●			\$1,234.20

*For use with AV 2000 and AV-3000 SureSeal (sold separately)*

200830-30	●		●			●		\$1,047.60
200830-36	●		●				●	\$1,047.60
200833-30	●	●	●			●		\$1,234.20
200833-36	●	●	●				●	\$1,234.20

\*AV-PAPR hose connects directly to AV-series facepieces.

\*\*The C420 Plus PAPR is also approved for NIOSH non-CBRN applications; Additional configurations are available

### CBRN Canister:

Part Number	Description	Price
045135	CBRN Cap-1 Canister ☺	\$53.10

### Other NIOSH approved canisters:

Part Number	Description	Price
045170	MPC40PF	\$25.60
045123	Enforcement Cartridge	\$35.40
052683	HEPA/P100 Filter	\$11.30

**C420 Plus Powered Air Purifying Respirators (PAPR) Parts & Accessories**

Item Number	Description	Pieces Per Pkg	Part Number	Price
<b>FACEPIECE</b>		See pages 51-65		
	M120	1	See Pg 65	
	AV-3000 with SureSeal with Kevlar Head Harness	1	See Pg 51	
	AV-2000 with Grey Nosecup and Kevlar Head Harness	1	See Pg 55	
<b>Breathing Tubes</b>				
	30" Breathing Tube for M120	1	200700-30	\$120.40
	36" Breathing Tube for M120	1	200700-36	\$120.40
	30" AV-PAPR Breathing Tube for approved AV-Facepieces	1	200829-30	\$160.20
	36" AV-PAPR Breathing Tube for approved AV-Facepieces	1	200829-36	\$165.30
<b>C420 Plus PAPR Blower Unit</b>				
	C420 Plus PAPR Blower Kit (Blower, decon belt, air-flow indicator)	1	200698-00	\$1,063.90
	C420 Plus PAPR Blower only	1	200699-01	\$1,006.80
	Decontamination Belt	1	805359-01	\$65.00
	Airflow Indicator	1	805374-01	\$36.10
<b>BATTERIES, C420 Plus</b>				
	LiSO2 Battery	1	805358-01	\$120.80
	(Black) End cap for LiSO2 Battery		31002361	\$28.10
	NiMH Rechargeable Battery Conversion Kit, (Single Bank Charger, NiMH Battery, End Cap)	1	200701-01	\$445.80
	NiMH Rechargeable Battery Pack	1	31001504	\$197.90
	(Green) End Cap for NiMH Rechargeable Battery	1	31001506	\$27.60
	Single Unit Battery Recharger	1	200703-01	\$241.80
<b>CARRY CASE</b>				
	Scott duffle bag carry case	1	31000578	\$43.90
<b>CARTRIDGES AND CANISTERS</b>		See Previous Page		



## 742 SERIES

### FILTERS & CARTRIDGES

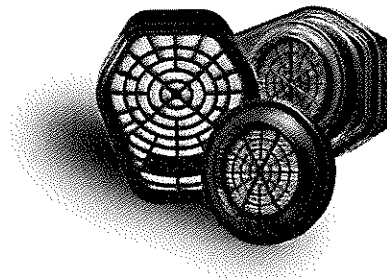

Select part numbers from this product line are part of the Scott Fast Trax Program. Contact your Regional Manager or Scott Customer Service for more details.

#### 742 Series Twin Filter and Chemical Cartridges

Part Number	Description	Pieces Per Pkg	Price
7422-BA1	Organic Vapor	1 Pair	\$12.00
7422-BB1	Organic Vapor/P100	1 Pair	\$23.30
7422-CD1	Tear Gas /P100	1 Pair	\$29.70
7422-FP1	P100 Filter	1 Pair	\$10.00
7422-FP4	P100 Filter (Carton of 80 Pair)	80 pair	\$800.00
7422-FN5	Particulate N95 stand alone filter (case of 50 pair)	50 pair	\$147.00
7422-GA1	Ammonia/Methylamine	1 Pair	\$14.00
7422-GB1	Ammonia/Methylamine/P100	1 Pair	\$25.60
7422-PD1	TEDA-P100	1 Pair	\$37.70
7422-SC1	Multi-Purpose	1 Pair	\$13.10
7422-SD1	Multi-Purpose / P100	1 Pair	\$24.90
7422-WA1	Acid Gas	1 Pair	\$12.90
7422-WB1	Acid Gas/P100	1 Pair	\$24.60
7422-YC1	Organic Vapor/ Acid Gas	1 Pair	\$12.70
7422-YD1	Organic Vapor / Acid Gas / P100	1 Pair	\$24.00
7422-ZA1	Mercury Vapor/Chlorine Gas	1 Pair	\$25.00
7422-ZB1	Mercury Vapor/Chlorine Gas/P100	1 Pair	\$36.90

#### Particulate Filter Accessories

Part Number	Description	Pieces Per Pkg	Price
7422-FE4	N95 Filter Cover + Retainer, Reusable (5 pair of 7422-FE1). Holds the N95 filter for stand alone use.	5 pair	\$85.00
7422-FC4	N95 Filter Covers, Reusable (5 pair of 7422-FC1). Cover attaches N95 to chemical cartridge.	5 pair	\$60.00

#### Fit Check Seal Kit

Part Number	Description	Pieces Per Pkg	Price
7422-FG4	Box of 5 pair of 7422-FG1 (Reusable filter cover + gasket) Facilitates negative pressure leak check with chemical cartridges	5 pair	\$115.00



# 40mm SERIES

CARTRIDGES & CANISTERS



## 40mm Series Canisters

Part Number	Description	Pieces Per Pkg	Price
805557-01	MPC Plus Cartridge	1	\$23.00
052683	P100 Cartridge	1	\$11.30
045123	Enforcement Cartridge	1	\$35.40
045135	CBRN Cap-1 Canister 	1	\$53.10

## FACEPIECE ADAPTERS

FOR CARTRIDGES & CANISTERS

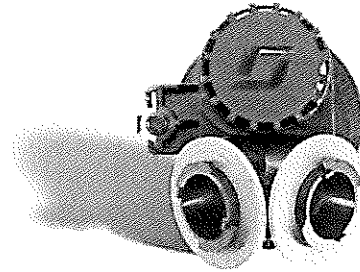

### Facepiece Adapters

Part Number	Description	Pieces Per Pkg	Price
805622-01	742 Series Twin Cartridge 1/4 Turn Adapter	1	\$43.50
805059-01	40mm Cartridge Adapter	1	\$43.70
200423-01	40mm First Responder Adapter	1	\$57.40
10011688	Exhalation Cover for 805622-01	1	\$9.40

### Quantitative Fit Testing Adapters for use with TSI Portacount (for pricing, see page 75)

Facepiece to be Fit Tested	Quantitative Fit Test Probe Adapter Required	Filter Required	Facepiece Adapter Required
742 Cartridge Series	7422-FT1	7422-FP1	805622-01
Xcel Half Mask	●	●	
Promask 25	●	●	
AV-2000, AV-3000, Weld-O-Vista	●	●	●
40mm Cartridge Series	805628-01	052683	805059-01
AV-2000, AV-3000, Weld-O-Vista	●	●	●
M110, M120	●	●	

### Quantitative Fit Testing Adapters for use with Fit Tester 3000

Facepiece to be Fit Tested	Quantitative Fit Test Probe Adapter Required	Filter Required	Facepiece Adapter Required
742 Cartridge Series	805816	7422-FP1	805622-01
Xcel Half Mask	●	●	N/A
Promask 25	●	●	N/A
AV-2000, AV-3000, Weld-O-Vista	●	●	●

# BITREX

## QUALITATIVE FIT TEST KIT

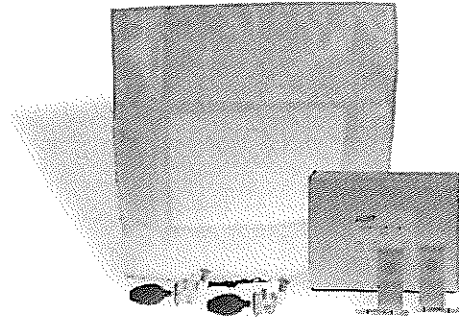

### Bitrex Qualitative Fit Test Kit

Part Number	Description	Pieces Per Pkg	Price
2017070	Bitrex Qualitative Fit Test Kit	1	\$246.90

### Bitrex Qualitative Fit Test Kit - Spare Parts

Part Number	Description	Pieces Per Pkg	Price
2017093	Fit Test Solution Applicator Kit (6 ampoules/box)	6	\$23.50
2017092	Sensitivity Solution Applicator Kit (6 ampoules/box)	6	\$23.50
2017094	Nebulizer	1	\$85.70
2017095	Test Hood	1	\$34.70

### Fit Test Parts For Use With 742 Series Twin Cartridges

Part Number	Description	Pieces Per Pkg	Price
805622-01	742 Series Twin Cartridge 1/4 Turn Adapter	1	\$43.50
7422-FP1	P100 Filter, 742 Series	1	\$10.00
7422-BA1	Organic Vapor Cartridges, 742 Series	1	\$12.00

### Fit Test Parts and Accessories For Use With 40mm Series Canisters

Part Number	Description	Pieces Per Pkg	Price
805059-01	40mm Canister Adapter	1	\$43.70
052683	40mm HEPA Cartridge	1	\$11.30

**SPEED-EVAC**  
MOUTHBIT RESPIRATOR

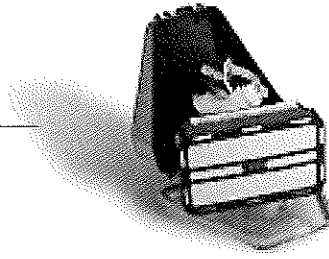

Select part numbers from this product line are part of the Scott Fast Trax Program. Contact your Regional Manager or Scott Customer Service for more details.

**Speed-Evac 90 Series Mouthbit Respirators**

Part Number	Description	Pieces Per Pkg	Price
803834-01	Acid Gas, With Pouch	1	\$29.00
803834-03	Acid Gas, With Case	1	\$43.00
803834-30	Acid Gas, With Pouch	30	\$863.00
803834-32	Acid Gas, With Case	30	\$1,283.00
803839-01	Ammonia, With Pouch	1	\$29.00
803839-03	Ammonia, With Case	1	\$43.00
803839-30	Ammonia, With Pouch	30	\$863.00
803839-32	Ammonia, With Case	30	\$1,283.00

**Speed-Evac 90 Series Mouthbit Respirators Part and Accessories**

Part Number	Description	Pieces Per Pkg	Price
10007997	Mouthbit Noseclip	1	\$2.00
10008212	Mouthbit Replacement Bag	1	\$1.80
10008221	Mouthbit Belt Clip Retainer	1	\$1.80

# CHARGE STATIONS

## GUARDIAN & REVOLVEAIR

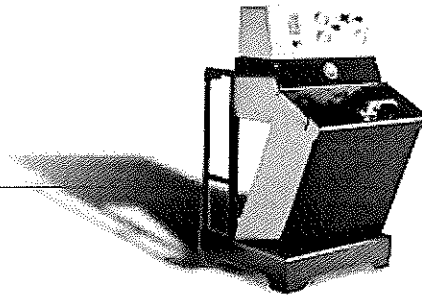

### Charge Stations Price Configurator

Model	Price	Base	Price	Fill Panel	Price	Dual Pressure	Price	Auxiliary Low Pressure	Price	Auxiliary High Pressure	Price	Cutout	Price	Cascade Panel	Price	Options	Price
				0 None	N/C	0 None	N/C							0 0 None	N/C		
1 Guardian	\$6,400	1 Yes	N/C	1 Stationary	\$675	1 2.5 & 4.5	\$1,510	1 Yes	\$990	1 Yes	\$1,120	1 Yes	N/C			0 1 CGA Adapter	N/C
2 RevolveAir	\$7,737	2 No	N/C	2 Mobile	\$675	2 2.5 & 5.5	\$1,510	2 No	N/C	2 No	N/C	2 No*	N/C	0 2 2 Bank	\$1,350	0 2 DIN Adapter	N/C
3 RevolveAir Mobile	\$7,737					3 4.5 & 5.5	\$1,510							0 3 3 Bank	\$1,600	0 3 SCUBA Adapter/ RevolveAir & CGA	\$300
														0 4 4 Bank	\$2,050	0 4 SCUBA Adapter/ Guardian & CGA	\$160
														0 5 5 Bank	\$2,500	0 5 SCUBA Adapter/ RevolveAir & DIN	\$300
														0 6 6 Bank	\$2,950	0 6 SCUBA Adapter/ Guardian & DIN	\$160
														A 0 Auto NO storage	\$4,300		
														A 1 with storage	\$4,300		

**Part Number:**

Select one number per box from the chart above that corresponds to your choice

AF																	
----	--	--	--	--	--	--	--	--	--	--	--	--	--	--	--	--	--

**Price:**

Select the price that corresponds to the number selected above

--	--	--	--	--	--	--	--	--	--	--	--	--	--	--	--	--	--

**Total:**  
Add up all prices to the left

--

**Example**  
 RevolveAir Mobile;  
 with No Base;  
 with Mobile Fill Panel;  
 with Dual Pressure;  
 with Auxiliary Low Pressure;  
 with No Auxiliary High Pressure;  
 with Cutout;  
 with 5 Bank Cascade Panel;  
 with SCUBA Adapter / RevolveAir & CGA

AF	3	2	2	1	1	2	1	0	5	1	1
	\$7,737	\$0	\$675	\$1,510	\$990	\$0	\$0	\$2,500	\$300		

\$13,712
----------

This price configurator is a guide to Scott's breathing air systems product part numbers. Not all part numbers configured with this chart can be manufactured. Please confirm part numbers with Scott's Customer Service Department, a Scott Regional Manager, or your local Scott Authorized Distributor of breathing air systems.

\* 2 No (Stand Alone - No Compressor)  
 \*\* 3 No (Charge Station - Wall Mount)

## COMPRESSORS

### SIMPLE AIR & HUSH AIR

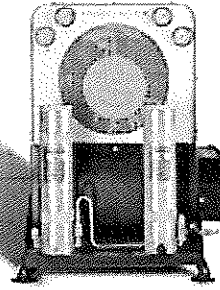

### Stationary & Horizontal Compressors Price Configurator

Model	Price	Voltage/Phase/Hz	Price	Horsepower	Price	Controller	Price	Frame	Price	Language	Price	Options	Price
0 1	\$14,720	208 Volt / 1 Phase / 60Hz	N/C	5 HP	\$490	Basic	\$700	1 Open	N/C	1 English	N/C	1 Wall Mount	N/C
0 2	\$14,475	230 Volt / 1 Phase / 60Hz	N/C	7.5 HP	\$590	CO Monitor	\$2,080	2 Simple Enclosed	\$3,045	2 Spanish	N/C	2 Moisture Indicator	\$180
0 3	\$18,354	208 Volt / 3 Phase / 60Hz	N/C	10 HP	\$1,020	Dew Point	\$1,360	3 Hush Enclosed	\$3,255	3		3 Wall M. W/Moist. Ind.	\$180
0 4	\$17,770	230 Volt / 3 Phase / 60Hz	N/C	15 HP	\$1,405	CO & Dew Point	\$3,440	4 Open/Remote Air Simple	\$130	4			
0 5	\$26,936	460 Volt / 3 Phase / 60Hz	N/C	20 HP	\$1,950	CO Monitor 1	\$2,390	4 Open/Remote Air Hush	\$230	4			
		220 Volt / 3 Phase / 50Hz	N/C			CO & Dew Point 1	\$3,750	5 Simple Enclosed/ Remote Air	\$3,045	5			
		380 Volt / 3 Phase / 50Hz	N/C					6 Hush Enclosed/ Remote Air	\$3,470	6			
		415 Volt / 3 Phase / 50Hz	N/C										
		220 Volt / 1 Phase / 50Hz	N/C										

**Part Number:**  
Select one number per box from the chart above that corresponds to your choice

AC								1		
----	--	--	--	--	--	--	--	---	--	--

**Price:**  
Select the price that corresponds to the number selected above

--	--	--	--	--	--	--	--	--	--	--

**Total:**  
Add up all prices to the left

--

**Example**  
Simple Air / 6000 psi / 3 Phase Model  
with 230 Volt / 3 Phase / 60 Hz;  
with 10 HP;  
with CO & Dew Point Controller;  
with Simple Enclosed Frame;  
with Blue/White Color;  
in English;  
with no Options

AC	0	4	0	4	3	4	2	1	1	0
	\$17,770		\$0	\$1,020	\$3,440	\$3,045	\$0	\$0	\$0	

\$25,275
----------

This price configurator is a guide to Scott's breathing air systems product part numbers. Not all part numbers configured with this chart can be manufactured. Please confirm part numbers with Scott's Customer Service Department, a Scott Regional Manager, or your local Scott Authorized Distributor of breathing air systems.

1 with calibration kit

## LIBERTY DUAL POWER

LIBERTY I, II & SLIP-IN

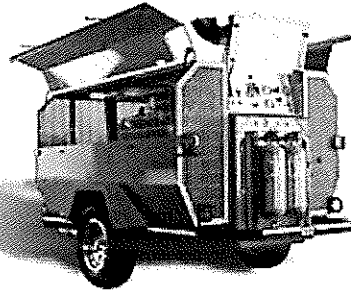

### Liberty Dual Power Price Configurator

Model	Price	HP/Voltage/Hz All models are 3 Phase	Price	Brakes Tow Hitch	Price	Light Tower Generator	Price	Cold Weather Package	Price	Color †	Price	Pressure Reel High & Low	Price	SCBA Storage Rack	Price	Language	Price	Options	Price
1 Liberty I	\$96,963	0 1 20 HP/ 208 Volt/ 60 Hz	N/C	0 None	N/C	0 None	N/C	1 Yes	\$1,495	1 Red	N/C	0 None	N/C	1 Yes	\$3,352	1 English	N/C	0 STD CGA	N/C
2 Liberty II	\$105,875	0 2 20 HP/ 230 Volt/ 60 Hz	N/C	1 Surge/Ball	N/C	1 Light/Gen	\$2,700	2 No	N/C	2 Other	\$2,970	1 Low	\$4,026	2 No	\$0	2 Spanish	N/C	1 STD CGA **	\$345
3 Liberty Slip-In	\$75,726	0 3 20 HP/ 460 Volt/ 60 Hz	N/C	2 Electric/Ball	\$843	2 Gen/No Light	\$1,438			3 Tan	\$2,970	2 High	\$5,324			3 French	N/C	2 DIN **	\$345
4 Liberty Slip-In (Open Frame)	\$67,958	0 4 20 HP/ 220 Volt/ 50 Hz	N/C	3 Surge/Pintle	N/C							3 Low & High	\$9,240			4 Mandarin	N/C	3 STD/SCUBA	\$340
5 Lib II with Auto Cascade	\$113,190	0 5 20 HP/ 380 Volt/ 50 Hz	N/C	4 Electric/Pintle	\$843													4 STD/SCUBA	\$340
		0 6 20 HP/ 415 Volt/ 50 Hz	N/C	5 Surge/Ball *	\$798													5 STD/SCUBA**	\$684
				6 Electric/Ball *	\$1,590													6 STD/SCUBA**	\$684
				7 Surge/Pintle *	\$798													7 DIN/SCUBA**	\$684
				8 Electric/Pintle *	\$1,590														

**Part Number:**  
Select one number per box from the chart above that corresponds to your choice

AL																			
----	--	--	--	--	--	--	--	--	--	--	--	--	--	--	--	--	--	--	--

**Price:**  
Select the price that corresponds to the number selected above

--	--	--	--	--	--	--	--	--	--	--	--	--	--	--	--	--	--	--	--

**Total:**  
Add up all prices to the left

--

† For special order colors, there is an upcharge of \$2,500 (RAL# needed)

**Example**  
Liberty II Model;  
with 20HP / 220 Volt/ 3 Phase / 50Hz., with Electric Brakes and Ball Hitch;  
with no Light Tower or Generator;  
with a Cold Weather Package;  
in Red;  
with High Pressure Reel;  
with no Storage Rack,  
in English,  
with STD adapters

AL	2	0	4	2	0	1	1	2	0	1	0
	\$96,963	\$0	\$843	\$0	\$1,495	\$0	\$5,324	\$0	\$0	\$0	\$0

\$104,625
-----------

This price configurator is a guide to Scott's breathing air systems product part numbers. Not all part numbers configured with this chart can be manufactured. Please confirm part numbers with Scott's Customer Service Department, a Scott Regional Manager, or your local Scott Authorized Distributor of breathing air systems.

\* with spare tire  
\*\* with calibration



## STORAGE & RACKS

### HORIZONTAL & VERTICAL

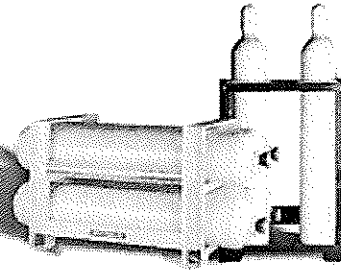

### Storage & Racks Price Configurator

Cylinder Type	Price	Rack	Price	Quantity	Price			Plumbing & Quality	Price	Hoses	Price	Options	Price				
					(ASME 6000 psi)	(DOT 5000 psi)	(DOT 6000 psi)										
				0 0	None	N/C	N/C	N/C	0 0	None	N/C	0	without Charge Station	N/C			
1 ASME 6000 psi	N/C	1 Wall 2	\$220	0 1	One	\$2,490	\$1,030	\$1,520	A 4	4 Auto Cascade	\$350	1 0	10 ft.	N/C	1	with Revolve Air	N/C
		2 Wall 4	\$320	0 2	Two	\$5,170	\$2,145	\$3,040	B 1	1 Bulk	N/C	1 5	15 ft.	N/C	2	with Guardian	N/C
3 DOT 5000 psi	N/C	3 Vertical Back 2	\$1,375	0 3	Three	\$7,330	\$3,220	\$4,040	B 2	2 Bulk	N/C	2 0	20 ft.	N/C			
4 DOT 6000 psi	N/C	4 Vertical Back 4	\$1,825	0 4	Four	\$9,975	\$4,270	\$6,240	B 3	3 Bulk	N/C	2 5	25 ft.	N/C			
		5 Vertical Stand Alone 2	\$1,375	0 5	Five	\$12,045	N/A	N/A	B 4	4 Bulk	N/C	3 0	30 ft. *	\$240			
		6 Vertical Stand Alone 4	\$1,825	0 6	Six	\$14,725	N/A	N/A	B 5	5 Bulk	N/C	4 0	40 ft. *	\$310			
		7 Horizontal 2	\$1,525						B 6	6 Bulk	N/C	5 0	50 ft. *	\$380			
		8 Horizontal 4	\$1,625						C 2	2 Cascade	\$140	6 0	60 ft. *	\$450			
		9 Horizontal 6	\$1,985						C 3	3 Cascade	\$190	7 0	70 ft. *	\$520			
									C 4	4 Cascade	\$250	8 0	80 ft. *	\$590			
							C 5	5 Cascade	\$350	9 0	90 ft. *	\$670					
							C 6	6 Cascade	\$360								

**Part Number:**  
Select one number per box from the chart above that corresponds to your choice

AR										
----	--	--	--	--	--	--	--	--	--	--

**Price:**  
Select the price that corresponds to the number selected above

--	--	--	--	--	--	--	--	--	--

**Total:**  
Add up all prices to the left

--

\* Bulk systems require one hose, cascade systems require one hose per bank

**Example**  
DOT 5000 psi Model  
Four Quantity;  
with Wall4 Rack;  
with 4 Bulk Plumbing;  
with 20 Foot Hose;  
with no Options

AR	3	2	0	4	B	4	2	0	0
	\$0	\$320		\$4,270		\$0	\$0	\$0	

\$4,590
---------

This price configurator is a guide to Scott's breathing air systems product part numbers. Not all part numbers configured with this chart can be manufactured. Please confirm part numbers with Scott's Customer Service Department, a Scott Regional Manager, or your local Scott Authorized Distributor of breathing air systems.



## NOTES

---

# PROTÉGÉ

## PORTABLE MULTI-GAS MONITOR PRICE CONFIGURATOR

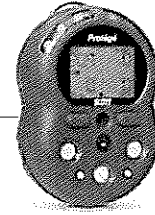

### PRO-A-B-C-D-E-F

**(A) Protégé Monitor Base Instrument Sensor Configuration** - Protégé monitor standard equipment includes: CD w/manuals, PC software and interactive training, torx tool, calibration cup, quick reference guide, datalogging, LEL configured with methane. Pentane or propane configuration upon request.

1	O2/LEL/CO/H2S	\$500.00
2	O2/LEL/CO	\$425.00
3	O2/LEL/H2S	\$425.00
4	O2/LEL	\$320.00
5	LEL	\$300.00
7	CO	\$320.00
8	H2S	\$320.00
9	LEL/CO	\$340.00
A	LEL/H2S	\$340.00
B	O2/CO	\$340.00
C	O2/H2S	\$340.00
D	CO/H2S	\$340.00

**(B) Region** - This choice determines if an international charging adapter will be shipped if ordered.

1	United States/Americas	\$0.00
2	Brazil/NMetro	\$0.00
3	Canada/CSA	\$0.00
4	Russia/GOST	\$0.00
Z	All others	\$0.00

**(C) Pump Kit** - Includes pump, clear probe and 10 foot of tubing.

1	Yes	\$245.00
2	No	\$0.00

**(D) Calibration Kit** - Includes 34ltr bottle of gas, regulator and tubing. Price dependent on sensor configuration.

1	Yes	\$0.00
2	No	\$0.00
	Oxygen, H2S, CO and combustible gas cal kit adder (Methane)	\$375.00
	Oxygen, CO and combustible gas cal kit adder (Methane)	\$230.00
	Oxygen, H2S and combustible gas cal kit adder (Methane)	\$230.00
	Combustible or Combustible/O2 Instrument gas calibration kit adder (Methane)	\$220.00
	Oxygen, H2S, CO and combustible gas cal kit adder (Pentane 58ltr)	\$431.00
	Oxygen, H2S, CO and combustible gas cal kit adder (Propane)	\$375.00

**(E) Charger Options**

1	Standard Charger - Includes charger/programmer, AC adapter, USB cable for PC interface	\$125.00
2	No Charger	\$0.00
3	Car Charger	\$25.00
4	Standard Charger + Car Charger	\$150.00

**(F) Foam Lined Carrying Case - Secure storage for calibration gas, charger, pump, probe and instrument.**

1	Yes	\$80.00
2	No	\$0.00

## PROTÉGÉ

### PORTABLE MULTI-GAS MONITOR

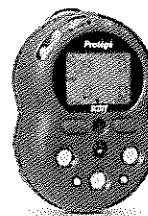

Select part numbers from this product line are part of the Scott Fast Trax Program. Contact your Regional Manager or Scott Customer Service for more details.

**Protégé Monitor Kits:** Includes gas monitor, charger, torx tool, manual, CD with PC software, USB cable and calibration adapter. LEL configured with methane. Pentane or propane configuration upon request.

Part Number	Part Number	Description	Price
US	CANADA		
PRO-112212	PRO-132212	O2/LEL/CO/H2S Gas Monitor Kit	\$625.00
PRO-212212	PRO-232212	O2/LEL/CO Gas Monitor Kit	\$550.00
PRO-312212	PRO-332212	O2/LEL/H2S Gas Monitor Kit	\$550.00
PRO-412212	PRO-432212	O2/LEL Gas Monitor Kit	\$445.00
PRO-512212	PRO-532212	LEL Gas Monitor Kit	\$425.00

**Confined Space Kits:** Includes all the items above, plus pump, probe, tubing and calibration kit in a foam lined carry case. LEL configured with methane. Pentane or propane configuration upon request.

Part Number	Part Number	Description	Price
US	CANADA		
PRO-111111	PRO-131111	O2/LEL/CO/H2S Confined Space Kit	\$1,325.00
PRO-211111	PRO-231111	O2/LEL/CO Confined Space Kit	\$1,105.00
PRO-311111	PRO-331111	O2/LEL/H2S Confined Space Kit	\$1,105.00
PRO-411111	PRO-431111	O2/LEL Confined Space Kit	\$990.00

### Protégé Monitor Spare Parts

Part Number	Description	Price
096-3249	Protege Top Case Replacement Kit	\$34.00
076-0209	Protege Case Screw with Sealant	\$2.40
093-0230	CO/H2S Sensor	\$250.00
093-0231	Combustible sensor	\$150.00
093-0524	Combustible Sensor (Canada)	\$150.00
093-0232	Oxygen sensor	\$120.00
093-0470	CO sensor	\$160.00
093-0471	H2S sensor	\$160.00
009-0050	Horn - O-ring	\$1.00
023-0024	LCD foam pad	\$2.00
096-3247	LCD assembly - foam/zebra strips/LCD	\$20.00
096-3259	Pump	\$195.00
096-3259-CSA	Pump (Canada)	\$195.00
074-0547	Calibration cup	\$2.00
073-0324	Torx tool #8	\$6.00
074-0558	Dummy sensor	\$6.00
096-3366	CD (manual, quick guide, Protégé monitor PC software, training)	\$5.30
062-0026	Quick guide	\$5.00
096-3278	Alligator clip and screw	\$4.00
077-0298	Probe particulate filter (Quantity = 1 Filter)	\$3.00
077-0317	Probe hydrophobic filter	\$6.00
028-0045	AC adapter	\$15.00
028-0046	International plugs for Europe, UK, Australia, and Asia	\$5.00
028-0052	DC Adapter (allows for charging from car cigarette lighter)	\$25.00

**Protégé Monitor Accessories**

Part Number	Description	Price
077-1353	USB cable	\$10.00
096-3273	Foam lined carry case	\$80.00
096-3276	Americas charger	\$135.00
096-3277	International charger	\$135.00
096-3271	Pump kit (Pump, 10 ft. clear sample tubing, clear probe w/hydrophobic & particulate filters)	\$245.00
096-3271-CSA	Pump Kit, Canada	\$245.00
096-3167	10 ft. clear sample tubing	\$16.00
093-0148	Clear probe with hydrophobic and particulate filters	\$63.00
093-0526	Masterdock, Automated Bump test and calibration station, AC or battery powered. (Utilizes 103L 6D or 58L 8AL or 34L 2AL cylinder, calibration gas sold separately.)	\$1,500.00
096-3283-1	Six Unit Protégé Multi-Charger (United States,Canada)	\$420.00
096-3283-2	Six Unit Protégé Multi-Charger (UK, Hong Kong, Singapore)	\$420.00
096-3283-3	Six Unit Protégé Multi-Charger (Europe & South America)	\$420.00
096-3283-4	Six Unit Protégé Multi-Charger (Asia & Australia)	\$420.00
096-3283-5	Six Unit Protégé Multi-Charger (Brazil)	\$420.00
062-0027	Protégé Multi-Charger quick guide	\$5.30
028-0047	Protégé Multi-Charger 9VDC/5A table top power supply (cord set sold separately)	\$39.00
028-0048	North American detachable cord set for Multi-Charger	\$15.00
028-0049	UK British detachable cord set for Multi-Charger	\$15.00
028-0050	European detachable cord set for Multi-Charger	\$15.00
028-0051	Australian detachable cord set for Multi-Charger	\$15.00

## Protégé Monitor Calibration Equipment

Part Number	Description	Price
096-2506-16	.5 L Regulator, tubing, 34ltr. LEL/O2/CO/H2S Calibration Kit (Methane)	\$390.00
096-2506-18	.5 L Regulator, tubing, 34ltr. LEL/O2/CO Calibration Kit (Methane)	\$239.00
096-2506-20	.5 L Regulator, tubing, 34ltr. LEL/O2/H2S Calibration Kit (Methane)	\$390.00
096-3272	.5 L Regulator, tubing, 34ltr. LEL Calibration Kit (Methane)	\$220.00
096-3392	.5 L Regulator, tubing, 34 ltr. LEL/O2/CO/H2S Calibration kit (Propane)	\$390.00
096-3393	.5 L Regulator, tubing, 58 ltr. LEL/O2/CO/H2S Calibration kit (Pentane)	\$446.00
077-0351	GAS CYL. 34L/2AL, LEL/O2/CO/H2S (Methane)	\$225.00
077-0352	GAS CYL. 58L, LEL/O2/CO/H2S (Methane)	\$281.00
077-0355	GAS CYL. 34L/2AL, LEL/O2/H2S (Methane)	\$236.00
077-0353	GAS CYL. 34L/7HP, LEL/O2/CO (Methane)	\$80.00
077-0354	GAS CYL. 103L/6D, LEL/O2/CO (Methane)	\$187.00
077-0357	GAS CYL. 34L/2AL, LEL (Methane)	\$53.00
077-0272	GAS CYL. 34L/2AL, H2S (25 ppm)	\$130.00
077-0273	GAS CYL. 34L/7HP, CO (50 ppm)	\$130.00
077-1379	GAS CYL. 58L/8AL, LEL/O2/CO/H2S (Pentane)	\$281.00
077-1269	GAS CYL. 34L/2AL, LEL/O2/CO/H2S (Propane)	\$225.00
077-0018	REGULATOR, 2AL/8AL/6D .5LPM	\$150.00
077-1238	REGULATOR, 7HP .5LPM	\$150.00

# PROTÉGÉ ZM

PORTABLE SINGLE-GAS MONITOR



**FastTrax**

Select part numbers from this product line are part of the Scott Fast Trax Program. Contact your Regional Manager or Scott Customer Service for more details.

## Protégé ZM Single Gas Monitor

Equipment includes: monitor with custom alarm setpoints in high visibility red housing with stainless steel alligator clip attached, calibration cup, CD with manuals and software.

Part Number	Description	Price
096-3459-01	Protégé ZM Single Gas CO Monitor (High Visibility Red)	\$169.00
096-3459-02	Protégé ZM Single Gas H <sub>2</sub> S Monitor (High Visibility Red)	\$169.00
096-3459-03	Protégé ZM Single Gas O <sub>2</sub> Monitor (High Visibility Red)	\$169.00

### Default Alarm Setpoint

CO (Carbon Monoxide)	Low Alarm/High Alarm: 35 ppm / 200 ppm
H <sub>2</sub> S (Hydrogen Sulfide)	Low Alarm/High Alarm: 10 ppm / 15 ppm
O <sub>2</sub> (Oxygen)	Low Alarm/High Alarm: 19.5% / 23.5%
<i>- Custom alarm setpoints available using Protégé ZM price configurator.</i>	
<i>Minimum order of 50 units required.</i>	

## Protégé ZM Accessories and Calibration Equipment

Part Number	Description	Price
096-3467-01	Protégé ZM Portable Test Station	\$1,895.00
096-3467-02	Protégé ZM Stationary Test Station	\$1,795.00
093-0588	Protégé IR Connect with USB Cable	\$95.00
093-0589	Protégé IR Connect Spare USB Cable	\$5.00
073-0355	Protégé ZM Alligator Clip	\$6.00
074-0564	Protégé ZM Calibration Cup	\$6.00
077-0272	H <sub>2</sub> S Single Gas Cylinder - H <sub>2</sub> S 25 ppm 2AL (34 liter) 11" x 2.9"	\$130.00
077-0246	CO Single Gas Cylinder - CO 100 ppm 6D (103 liter) 14" x 3.25"	\$230.00
077-0039	O <sub>2</sub> Single Gas Cylinder - O <sub>2</sub> 16% 6D (103 liter) 14" x 3.25"	\$184.00
077-0018	Regulator 2AL/8AL/6D .5LPM	\$150.00
096-3167	10 Ft. Clear Tygon™ Tubing	\$16.00
093-0582	Protégé ZM USB Memory Stick	\$20.00
096-3499	10 Ft. Polyethylene Tubing	\$10.00



# PROTÉGÉ ZM

PORTABLE SINGLE-GAS MONITOR  
PRICE CONFIGURATOR



## Protégé ZM Single Gas Monitor Price Configurator

Pricing Configurator only required for orders with custom alarm setpoints.  
Minimum order quantity is 50 units for custom alarm setpoints.  
Monitor base list price below includes a \$20 upcharge for custom alarm setpoints.

### PZMAB-C-D (e.g. PZMX1-19.5-23.5 or PZMC1-50-100)

(A) Gas Type - Protégé ZM Monitor with Custom Alarm Setpoints			
Equipment includes: monitor with custom alarm setpoints in high visibility red housing with stainless steel alligator clip attached, calibration cup, CD with manuals and software			
C	CO - Carbon Monoxide		\$189.00
H	H <sub>2</sub> S - Hydrogen Sulfide		\$189.00
X	O <sub>2</sub> - Oxygen		\$189.00
(B) Region			
1	cETLus, ATEX, IECEX		\$0.00
(C) Low Alarm Setpoint			
Depends on gas type chosen in item (A)			
1 - 300	Gas Type C - Carbon Monoxide	(No decimals allowed)	\$0.00
1 - 100	Gas Type H - Hydrogen Sulfide	(No decimals allowed)	\$0.00
1.0 - 30.0	Gas Type X - Oxygen	(Decimals allowed e.g. 19.5)	\$0.00
(D) High Alarm Setpoint			
Depends on gas type chosen in item (A). Value must be higher than value chosen in item (C)			
1 - 300	Gas Type C - Carbon Monoxide	(No decimals allowed)	\$0.00
1 - 100	Gas Type H - Hydrogen Sulfide	(No decimals allowed)	\$0.00
1.0 - 30.0	Gas Type X - Oxygen	(Decimals allowed e.g. 19.5)	\$0.00



## NOTES

---

## NOTES

---

## NOTES

---



P.O. Box 569  
Monroe, NC 28111  
Telephone: 800.247.7257  
Facsimile: 704.291.8330  
[www.scottsafety.com](http://www.scottsafety.com)  
[sh-sale@tycoint.com](mailto:sh-sale@tycoint.com)  
04.14

Nomex is a registered trademark of E.I. DuPont de Nemours and Company. | PBI Gold is a registered trademark of PBI Performance Products, Inc.  
Pyrotone is a registered trademark of Elizabeth Webbing Mills Co., Inc. | Kevlar is a registered trademark of E.I. DuPont de Nemours and Company.  
InfoTherm is a trademark of FLIR Systems, Inc. | PortaCount is a registered trademark of TSI, Inc.  
Bitrex is a registered trademark of Macfarlan Smith Ltd. | Con-Space is a registered trademark of Con-Space Communications, Ltd.  
MSL, Smokesight, and TCR - True Color Reception are a registered trademarks of TriSpec, Inc.  
All Rights Reserved.



All prices listed herein supercede all other price lists, including (but not limited to) Scott master PDF price list. All prices are subject to change.

Scott Safety Master Price List - Prices Effective February 1, 2014

ITEM	PRODUCT DESCRIPTION	SIGNAL CODE	Minimum Order Quantity	2014 LIST PRICE
31001544	cyl, carbon wrap 15', 4500 psi, 15 yr		1	\$ 565.00
00-1164	SCREW,TRUSS HD,SS,6-32X0.375 L		1	\$ 1.90
0019-0398	REPLACEMENT SENSOR		1	\$ 88.00
0023-7354	BATTERY PACK, TLV-I.S.		1	\$ 699.00
0023-7383	10 IN. ALUM PROBE/5FT TEF HOSE		1	\$ 198.00
0051-1057	COMBUSTIBLE SENSOR, LEL		1	\$ 260.00
0051-1120	(DOT)CYL 500 PPM HEXANE		1	\$ 250.00
0051-1175	PCB ASSY, SENSOR BASE		1	\$ 61.00
0051-1219	BATTERY CHARGER, 120VAC		1	\$ 96.00
0051-1819	5 FT DAYLON EXT HOSE, W/FTNGS		1	\$ 83.00
0051-7331	OXYGEN CELL		1	\$ 171.00
0054-7001	02 SENSOR BODYGUARD		1	\$ 208.00
009-0050	O-RING, EPDM #010		1	\$ 1.00
0104-5255	FERRITE SUPPRESSOR .296 DIA		1	\$ 1.00
012574	NOSECUP,REGULAR M95		1	\$ 39.52
012575	NOSECUP,SMALL M95		1	\$ 39.52
012577	EXHV SET ASSY, M120/M98		1	\$ 7.28
012592	PLUG, SPEECH DIAPHRAGM		1	\$ 6.76
012593	M95, BOTTLE W/BOTTLE CAP		1	\$ 29.12
012594	MOUTHPIECE DRINKING DEVICE		1	\$ 6.55
012597	LID,DRINKING DEVICE		1	\$ 7.59
012598	M95 HEAD HARNESS		1	\$ 30.16
012688	COVER,EXHALATION VALVE PROMASK		1	\$ 8.01
012692	HEAD HARNESS NR, PROMASK		1	\$ 30.16
012693	VISOR FRAME REPL SET PM		1	\$ 12.48
012694	HARNESS BUCKLES SET OF 5		1	\$ 8.63
012695	VISOR, PROMASK POLYCARB		1	\$ 32.66
012698	PROMASK LENS COVERS 10 PKG		1	\$ 32.66
012773	V.S., NOSECUP SET OF 2		1	\$ 5.41
012774	DISCS, VALVE SET OF 4 PM40		1	\$ 11.86
012775	HEAD HARNESS TEXTILE PROMASK		1	\$ 30.16
012776	NOSECUP W/FASTENING RING		1	\$ 37.30
012777	40 MM PLUG, BLACK PM40		1	\$ 3.90
012778	ASSY KIT,SPEECH DIAPHRAGM(PLY)		1	\$ 15.10
012779	KIT,SPEECH CHANNEL		1	\$ 15.00
012795	VISOR, PROMASK HARD COATED		1	\$ 102.00
012798	SPEC KIT, PROMASK, M95		1	\$ 20.80
013013	M120 CBRN HC		1	\$ 266.00
013014	M120 CBRN HC SMALL		1	\$ 266.00
013023	PROMASK 25, POLY LENS, NET REG		1	\$ 143.00
013024	PROMASK 25, POLY LENS, RUB REG		1	\$ 145.00
013027	PROMASK 25 POLY LENS, RUB SM		1	\$ 145.00
013028	PROMASK 25 POLY LENS, NET, SM		1	\$ 143.00
013099	M98 DRINKING DEVICE		1	\$ 36.40
013222	M110,CBRN,SMALL RIOT W/DRINK		1	\$ 296.40
013242	M110,CBRN SMALL RIOT W/O DRINK		1	\$ 266.00
013262	M110,CBRN,M/L RIOT W/O DRINK		1	\$ 266.00
013282	M110,CBRN,M/L RIOT W/DRINK DEV		1	\$ 296.40

013372	INH.VALVE SEATS EPDM SET OF 2		1	\$	9.80
013374	DISC,EXH VALVE		1	\$	9.20
013377	40MM PLUG, M120/M98		1	\$	3.10
0204-0022	BATTERY,LITHIUM(COIN TYPE)3.OV		1	\$	7.30
023-0017	GASKET, AUDIO TRANSDUCER		1	\$	3.20
023-0022	LC4G BATTERY FOAM		1	\$	1.00
023-0024	LC4G LCD FOAM		1	\$	2.00
028-0037	12VDC PWR/SUP, 110VAC INPUT		1	\$	79.00
028-0045	9VDC/.66A WALL CUBE,N.A. PLUG		1	\$	15.00
028-0046	MULT INPUT BLADES FOR 028-0045		1	\$	5.00
028-0047	9VDC/5A TABLE TOP POWER SUPPLY		1	\$	39.00
028-0048	N.AMERICAN DETACHABLE CORDSET		1	\$	15.00
028-0049	UK BRITISH DETACHABLE CORDSET		1	\$	15.00
028-0050	EUROPEAN DETACHABLE CORDSET		1	\$	15.00
028-0051	AUSTRALIAN DETACHABLE CORDSET		1	\$	15.00
028-0052	CAR CHARGER - OUTPUT=9VDC/1.3A		1	\$	25.00
028-0053	12 VOLT POWER SUPPLY		1	\$	79.00
028-0055	POWER SUPPLY PROTEGE ZM DS		1	\$	55.00
028-0056	POWER SUPPLY BLADE KIT		1	\$	12.00
045123	COMB FLTRS CF22 ENFORCE CNSTR		1	\$	35.40
045135	CBRN CAP 1 CANISTER		1	\$	53.10
045170	MPC40PF SINGLE CARTRIDGE FILTE		1	\$	25.60
048-0084	1/8"HIGH PRESSURE TUB FITTING		1	\$	18.00
052683	P100 CARTRIDGE,40MM		1	\$	11.30
0604-2723	FUSE, .5 AMP PLUG IN		1	\$	5.20
062-0026	PROTEGE QUICK GUIDE		1	\$	5.00
062-0027	MULTI-CHARGER QUICK GUIDE		1	\$	5.30
063548	PROFLOW BATT NIMH 3.8 AH		1	\$	168.50
063748	PROFLOW BATT NIMH 4.5 AH		1	\$	183.10
063791	CHARGER, ANSMANN AN4605 TRAVEL		1	\$	168.50
064072	BELT,TEXTILE		1	\$	21.60
064073	HOOD HOSE, EPDM		1	\$	41.00
064074	BELT,PVC DECON		1	\$	24.00
064077	80CM EPDM HOSE W/ANGLE CONNECT		1	\$	47.50
064078	80CM HOSE W/STRAIGHT CONNECTOR		1	\$	32.40
064079	100CM EPDM HOSE/ANGLE CONNECT		1	\$	47.50
064087	PAPR,PROFLOW 2 KIT		1	\$	857.00
064088	PAPR,PROFLOW 3 KIT (NO HOSE)		1	\$	951.60
068-0024	1/8ID,3/16OD FEP TUBING,COILED		1	\$	26.00
071-0159	TOUCH PANEL OVERLAY		1	\$	79.00
073-0324	LC4G T8 TORX L-KEY SHORT ARM		1	\$	6.00
073-0355	BELT CLIP PROTEGE ZM		1	\$	6.00
073-0359	PCBA IR BLOCK SHROUD		1	\$	20.00
073-0360	LI BATTERY HOLDER BRACKET		1	\$	10.00
073-0361	USB BLOCK SHROUD PROTEGE ZM		1	\$	26.00
073-0362	USB COVER BRACKET PROTEGE ZM		1	\$	26.00
073-0364	BRACKET, CAL CUP HOLDER		1	\$	8.00
074-0407	NON-OPERATING SENSOR POS. HOLD		1	\$	12.00
074-0546	CASE BOTTOM ASSEMBLY LC4G	Service Item	1	\$	6.25
074-0547	CAL CUP LC4G		1	\$	2.00
074-0558	LC4G SENSOR DUMMY INSERT		1	\$	6.00
074-0564	PROTEGE ZM CALIBRATION CAP		1	\$	6.00
074-0568	ASSEMBLY, P.D.S. THERMOFORM		1	\$	205.00
074-0569	CAL CUP MODIFICATION		1	\$	7.00
074-0570	PLUG, PRY OUT, 6/6 NYLON		1	\$	3.00
076-0104	SCREW,4-24X7/16FLTHD,TORX SOC.		1	\$	1.10
076-0120-55	SCREW,PHIL.PAN,4-40X1-1/4,SS		1	\$	1.10
076-0195	M2.5X4, PHILLIPS,PAN HEAD,SS	Service Item	1	\$	1.25
076-0203	M2.5X10 DELT PT SCREW, PROTEGE		1	\$	0.80
076-0209	M2.5 x 10 DELTA PT SEALING SCR		1	\$	2.40
077-0018	REGULATOR FIX FLOW 0.5LPM		1	\$	150.00

077-0025	H2S GAS BOTTLE,25 PPM, BAL AIR		1	\$	200.00
077-0026	GAS BOTTLE CO		1	\$	200.00
077-0039	OXYGEN GAS BOTTLE 16%		1	\$	184.00
077-0237	55 PPM CO/BAL N2 GAS CYLINDER		1	\$	208.00
077-0238	18.5% O2/BAL N2 GAS CYLINDER		1	\$	167.00
077-0239	20.9% O2/BAL N2 GAS CYLINDER		1	\$	167.00
077-0246	CO/AIR 100 PPM GAS CYLINDER,6D		1	\$	230.00
077-0248	2.5% METHANE GAS CYL.(212LTRS)		1	\$	172.00
077-0272	H2S GAS CYLINDER-25PPM,2AL-34L		1	\$	130.00
077-0273	CO GAS CYLINDER-50PPM, 7HP-34L		1	\$	130.00
077-0275	PROPANE/O2/CO/H2S GAS CYL. 58L		1	\$	281.00
077-0298	PARTICULATE FILTER, PROBE		1	\$	3.00
077-0317	PROBE HYDROPHOBIC FILTER		1	\$	6.00
077-0323	FITTING, LUER/BARB		1	\$	1.10
077-0351	METHANE/O2/CO/H2S GAS CYL. 34L		1	\$	225.00
077-0352	METHANE/O2/CO/H2S GAS CYL. 58L		1	\$	281.00
077-0353	METHANE/O2/CO GAS CYL. 34L		1	\$	80.00
077-0354	METHANE/O2/CO GAS CYL. 103L		1	\$	187.00
077-0355	METHANE/O2/H2S GAS CYL. 34L		1	\$	236.00
077-0356	METHANE/O2/H2S GAS CYL. 58L		1	\$	234.00
077-0357	METHANE/BAL. AIR CYL. 34L 2AL		1	\$	53.00
077-0362	METHANE/BAL. AIR CYL. 34L 7HP		1	\$	52.00
077-0366	INSERT,INNER SENSOR COVER		1	\$	5.20
077-0367	METHANE 99.9%,CYLINDER,7HP-34L		1	\$	80.00
077-0371	PENTANE/O2/BAL.N2 GAS CYL,103L		1	\$	156.00
077-0389	DEMAND FLOW REG, 5E W/CGA590		1	\$	416.00
077-0393	REPLACEMENT GRID,SENSOR CAP		1	\$	4.20
077-0410	100PPM ISOBUTYLENE/BAL AIR,7HP		1	\$	75.00
077-0411	100PPM ISOBUTYLENE/BAL AIR,2AL		1	\$	140.00
077-0422	10ML SYRINGE		1	\$	4.20
077-0426	100PPM ISOBUTYLENE/BAL AIR,6D		1	\$	180.00
077-0452	ABRASIVE DISC,1200 GRIT(P2500)		1	\$	1.10
077-0453	TWEEZERS, PRECISION, #1, SS		1	\$	12.00
077-0454	SCREWDRIVER, #1 PHILLIPS		1	\$	8.40
077-0455	NYLON ROD, 1/16DIA.X 6" LONG		1	\$	1.10
077-0456	LAMP, REPLACEMENT, 10.6EV PID		1	\$	364.00
077-0459	FILTER & CAP ASSEMBLY PID		1	\$	47.00
077-1238	REGULATOR, 0.5LPM (MODEL 713)		1	\$	150.00
077-1269	PROPANE/O2/CO/H2S GAS CYL.,34L		1	\$	225.00
077-1287	NITROGEN TRIFLUORIDE 10PPM CAL		1	\$	468.00
077-1342	CO GAS CYLINDER 50PPM 2AL34L		1	\$	135.00
077-1345	LC4G BUCKLE	Service Item	1	\$	3.25
077-1352	LC4G BATTERY HEAT SHRINK/WIRE		1	\$	50.00
077-1353	USB CABLE A TO MINI B CONN 3'		1	\$	10.00
077-1379	PENTANE/H2S/CO/O2 CYL: 58L/8AL		1	\$	281.00
077-1392	PORTABLE DOCKING STATION CASE		1	\$	210.00
077-1394	GAUGE PROTEGE ZM DOCKING STATI		1	\$	18.00
077-1395	BULKHEAD FITTING 5/16" TUBE		1	\$	18.00
093-0096	CITICEL C6 COMPT PIN O2 SENSOR		1	\$	245.00
093-0148	2701-E PROBE FOR PORT. PRODUCT		1	\$	63.00
093-0176	BATTERY CHRGR,SINGLE UNIT/INTF		1	\$	191.00
093-0230	CO/H2S SENSOR(DUAL TOX)(REV.3)		1	\$	250.00
093-0231	COMBUSTIBLE SENSOR		1	\$	150.00
093-0232	OXYGEN SENSOR		1	\$	120.00
093-0470	SENSOR (CO) CARBON MONOXIDE		1	\$	160.00
093-0471	SENSOR (H2S) HYDROGEN SULFIDE		1	\$	160.00
093-0524	SENSOR, COMBUSTIBLE		1	\$	150.00
093-0526	DOCKING STATION		1	\$	1,500.00
093-0527	DOCKING STATION USB CABLE		1	\$	42.00
093-0534	INLET FILTER REPLACEMENT PACK		1	\$	45.00
093-0582	USB STICK-2 GB PROTEGE ZM DOCK		1	\$	20.00

093-0587	SWITCH, PUSH BUTTON, BLACK		1	\$	22.00
093-0588	IR CONNECT ASSEMBLY		1	\$	95.00
093-0589	IR LINK, USB CABLE SPECIAL		1	\$	5.00
093-0590	IR LINK TOP ASSEMBLY		1	\$	25.00
093-0591	DC JACK&WIRE ASSY W/CONNECTOR		1	\$	18.00
093-0592	BATTERY ASSY. W/WIRING & PLUG		1	\$	36.00
093-0593	MAIN PCB ASSY. PROTEGE ZM DS		1	\$	245.00
096-2389	CALIBRATION KIT, 25 PPM H2S		1	\$	312.00
096-2390	CALIBRATION KIT, 50 PPM CO		1	\$	177.00
096-2391	O2 CHK GAS KIT, 18.5,20.9,23.5%		1	\$	302.00
096-2392	MEMBRANE REPLACEMENT KIT		1	\$	50.00
096-2443	MINI-SA VALUE KIT (CASE ONLY)		1	\$	47.00
096-2504-1	PUMP KIT,PUMP W/CLR TUBING		1	\$	177.00
096-2504-3	PUMP KIT,PUMP W/PROBE & TUBING		1	\$	242.00
096-2506-10	.5L BUL,TUBING,34L LEL/CO/H2S		1	\$	312.00
096-2506-11	.5L BUL,TUBING,58L LEL/CO/H2S		1	\$	359.00
096-2506-12	.5L BUL,TUBING,34L LEL/CO		1	\$	161.00
096-2506-13	.5L BUL,TUBING,103L LEL/CO		1	\$	265.00
096-2506-14	.5L BUL,TUBING,34L LEL/H2S		1	\$	312.00
096-2506-15	.5L BUL,TUBING,58L LEL/H2S		1	\$	359.00
096-2506-16	.5L REG,TUBING,34L LEL/CO/H2S		1	\$	390.00
096-2506-17	.5L REG,TUBING,58L LEL/CO/H2S		1	\$	437.00
096-2506-18	.5L REG,TUBING,34L LEL/CO		1	\$	239.00
096-2506-19	.5L REG,TUBING,103L LEL/CO		1	\$	343.00
096-2506-20	.5L REG,TUBING,34L LEL/H2S		1	\$	390.00
096-2506-21	.5L REG,TUBING,58L LEL/H2S		1	\$	437.00
096-2506-22	DF REG,TUBING,34L LEL/CO/H2S		1	\$	588.00
096-2506-23	DF REG,TUBING,58L LEL/CO/H2S		1	\$	634.00
096-2506-24	DF REG,TUBING,34L LEL/CO		1	\$	437.00
096-2506-25	DF REG,TUBING,103L LEL/CO		1	\$	541.00
096-2506-26	DF REG,TUBING,34L LEL/H2S		1	\$	588.00
096-2506-27	DF REG,TUBING,58L LEL/H2S		1	\$	437.00
096-2522	SENSOR ASSY,O2 SENSOR		1	\$	125.00
096-2523	SENSOR ASSY,CO SENSOR		1	\$	166.00
096-2524	SENSOR ASSY,H2S SENSOR		1	\$	166.00
096-2526	ASSY, NH3 SENSOR		1	\$	350.00
096-2527	ASSY, SO2 SENSOR		1	\$	312.00
096-2528	ASSEMBLY, DUAL TOXIC SENSOR		1	\$	312.00
096-2529	ASSY, PH3 SENSOR		1	\$	364.00
096-2531	ASSY, HCN SENSOR		1	\$	312.00
096-2532	ASSY, NO2 SENSOR		1	\$	312.00
096-2533	ASSY, NO SENSOR		1	\$	312.00
096-2534	SENSOR ASSY,LEL(SAFETY)(CITY)		1	\$	156.00
096-2535	NON-OPERATING SENSOR POS. HOLD		1	\$	16.00
096-2554	ASSY, 12V PWR CORD, CHARGER		1	\$	21.00
096-2656	CALIBRATION KIT, 5 PPM CL2		1	\$	520.00
096-2658	CALIBRATION KIT, 1 PPM PH3		1	\$	520.00
096-2660	CALIBRATION KIT, 25 PPM NH3		1	\$	520.00
096-2662	CALIBRATION KIT, 10 PPM SO2		1	\$	338.00
096-2862-1	ASSY,SCRUBBER ATTACH, NOX		1	\$	40.00
096-2862-2	ASSY, SCRUBBER ATTACH,CHARCOAL		1	\$	40.00
096-2884	SENSOR ASSY, %GAS COMBUSTIBLE		1	\$	208.00
096-2893	CALIBRATION KIT, 10 PPM HCN		1	\$	520.00
096-2894	CALIBRATION KIT, 5 PPM NO2		1	\$	520.00
096-2920	MITEX (PTFE) MEMBRANE REPL KIT		1	\$	78.00
096-2957	ASSY., CHARCOAL REFILL KIT		1	\$	31.00
096-3053-1	PHOSGENE TYPE 1 BADGE, 3 DAY		1	\$	7.00
096-3053-2	PHOSGENE TYPE 1 BADGE, 3 DAY		1	\$	364.00
096-3167	10 FT TYGON TUBING ASSY.		1	\$	16.00
096-3168	2 FT TYGON TUBING ASSY.		1	\$	7.30
096-3223	SCOUT CO2 SENSOR ASSEMBLY		1	\$	447.00



096-3245	LC4G PUMP ASSEMBLY		1	\$	150.00
096-3247	PROTEGE LCD KIT ASSEMBLY		1	\$	20.00
096-3249	LC4G TOP CASE REPLACEMENT KIT		1	\$	34.00
096-3257	LC4G CHARGER/COMM BOX ASSEMBLY		1	\$	90.00
096-3259	PROTEGE PUMP MODULE ASSEMBLY		1	\$	195.00
096-3259-CSA	PROTEGE PUMP MODULE ASSY.(CSA)		1	\$	195.00
096-3262	LC4G 4 GAS MAIN ASSY. -SENSORS	Service Item	1	\$	300.00
096-3263	LC4G 2/3 GAS MAIN ASSY-SENSORS		1	\$	300.00
096-3264	PROTEGE 4 GAS FINAL ASSEMBLY	Service Item	1	\$	523.00
096-3271	LC4G PUMP KIT		1	\$	245.00
096-3271-CSA	PROTEGE PUMP KIT (CSA)		1	\$	245.00
096-3272	.5L REG,TUBING,34L LEL CAL KIT		1	\$	220.00
096-3273	LC4G, HARD CARRY CASE ASSEMBLY		1	\$	80.00
096-3276	PROTEGE US CHARGER/COMM. KIT		1	\$	135.00
096-3277	PROTEGE GLOBAL CHARGER/COMM.		1	\$	135.00
096-3278	PROTEGE REPLACEMENT BUCKLE		1	\$	4.00
096-3283-1	PROTEGE MULTI-CHRGR F/A N.AMER		1	\$	420.00
096-3283-2	PROTEGE MULTI-CHRGR F/A UK BRI		1	\$	420.00
096-3283-3	PROTEGE MULTI-CHRGR F/A EUROPN		1	\$	420.00
096-3283-4	PROTEGE MULTI-CHRGR F/A AUSTRN		1	\$	420.00
096-3283-5	PROTEGE MULTI-CHRGR F/A BRAZIL		1	\$	420.00
096-3286	PROTEGE FIELD PROGRAMMER ASSY		1	\$	94.50
096-3366	PORTABLE INSTRUMENTS LINE CD		1	\$	5.30
096-3386	PROTEGE EXTERNAL PUMP FILTER		1	\$	9.00
096-3392	CALIBRATION KIT (PROPANE)		1	\$	390.00
096-3393	CALIBRATION KIT (PENTANE)		1	\$	446.00
096-3459-01	ProZM CO Red Assembly		1	\$	169.00
096-3459-02	ProZM H2S Red Assembly		1	\$	169.00
096-3459-03	ProZM O2 Red Assembly		1	\$	169.00
096-3467-01	ProZM TS Port Assembly		1	\$	1,895.00
096-3467-02	ProZM TS Stat Assembly		1	\$	1,795.00
096-3469	ASSEMBLY, MICROPHONE PLATE		1	\$	40.00
096-3470-1	REGULATOR ASSY PROTETE ZM DS		1	\$	405.00
096-3470-2	REGULATOR ASSY PROTETE ZM DS		1	\$	140.00
096-3474	PROTEGE ZM CD ASSEMBLY		1	\$	5.00
096-3499	POLYETHYLENE TUBING 1/4"ODx10'		1	\$	10.00
10000113	SCREW, RETAINING		1	\$	10.80
10000369	NIPPLE		1	\$	71.80
10004865	DECAL SKA-PAK CYLINDER		11	\$	4.80
10005135	FACE SEAL - LARGE		1	\$	48.30
10005201	ELBOW,STREET		1	\$	8.70
10005218	KNOB,REGULATOR PURGE	Service Item	1	\$	9.80
10005228	SUPPORT,VALVE TUBE		1	\$	1.10
10005229	SPRING DEMAND VALVE/LATCH		1	\$	3.10
10005233	PLATE, LATCH		1	\$	9.70
10005250	FILTER,CARTRIDGE-PRESS REDUCER	Service Item	1	\$	5.50
10005254	SCREW, RETAINER,SEAT *KB*	Service Item	1	\$	26.10
10005259	LEVER,PISTON	Service Item	1	\$	5.90
10005269	PLATE,TAB LOCK		1	\$	4.70
10005279	NIPPLE,COUPLING A.P.4.5		1	\$	99.80
10005284	KB SEAT,POPPET		1	\$	3.75
10005286	SHAFT,PRESS-TO-TEST	Service Item	1	\$	5.50
10005296	BODY,PRESSURE REDUCER		1	\$	655.20
10005299	SPRING,PRIMARY PRESS REDUCER	Service Item	1	\$	10.80
10005300	SPRING,SECONDARY PRESS REDUCER	Service Item	1	\$	10.80
10005302	PISTON,TRANSFER VLV AUTO ACT	Service Item	1	\$	12.50
10005303	SLEEVE,TRANS VALVE,AUTO ACT	Service Item	1	\$	34.30
10005305	RING,BACK-UP		11	\$	6.00
10005322	PLATE, APPROVAL	Service Item	1	\$	7.70
10005331	NIPPLE,COUPLING A.P.2.2		1	\$	46.80
10005354	LABEL,IDENTIFICATION		11	\$	3.75

10005368	GASKET		1	\$	12.50
10005375	WASHER, THRUST		1	\$	3.80
10005384	DECAL-CYLINDER		11	\$	3.75
10005431	LABEL, APPROVAL	Service Item	1	\$	6.00
10005473	PROBE, CONNECTING		1	\$	11.30
10005556	PLATE, IDENTIFICATION		11	\$	3.20
10005603	VALVE, INHALATION		1	\$	3.50
10005638	VALVE RELIEF		1	\$	168.50
10005654	PLUG DUMMY		1	\$	70.70
10005656	PUNCH PIN	Service Item	1	\$	45.80
10005657	PLIERS	Service Item	1	\$	126.90
10005658	PLIERS, RETAINING RING	Service Item	1	\$	126.90
10005756	OUTLET, CHECK VALVE		1	\$	25.50
10005773	SHAFT, PISTON	Service Item	1	\$	115.00
10005774	SLEEVE	Service Item	1	\$	11.30
10005775	SEAT, VALVE -KB-	Service Item	1	\$	42.60
10005776	HEAD, PISTON	Service Item	1	\$	24.90
10005856	PLUG		1	\$	39.50
10005898	BAIL, CYLINDER BAND		1	\$	22.60
10005913	AV/SOV EPDM FACESEAL SML-GREEN		1	\$	48.30
10005959	PACKING		1	\$	3.10
10005961	RETAINER, CHECK VALVE	Service Item	1	\$	72.80
10005973	PLUG		1	\$	44.70
10006212	FACE SEAL, X-LARGE		1	\$	47.60
10006289	HANGER, CYLINDER		1	\$	33.30
10006448	SPRING-RSPTR POSITIVE PRESS		11	\$	7.70
10006455	PACKING, PREFORMED		1	\$	4.40
10007327	TEENUT, CAPPED		1	\$	3.75
10007328	SCREW, SELF-LOCKING, TRUSS HD		1	\$	3.10
10007329	SCREW, SELF-LOCKING, TRUSS HD		1	\$	3.10
10007331	SLIDE		1	\$	2.80
10007358	LEVER, DIAPHRAGM	Service Item	1	\$	6.40
10007461	NUT, SELF-LOCKING		11	\$	2.80
10007462	SCREW, TRUSS HEAD (PHILLIPS)		11	\$	3.10
10007540	SPACER, BEARING		1	\$	19.20
10007560	PACKING, PREFORMED		1	\$	5.50
10007561	PACKING, PREFORMED		1	\$	2.80
10007562	PACKING, PREFORMED		1	\$	4.40
10007563	PACKING, PREFORMED	Service Item	1	\$	2.80
10007564	PACKING, PREFORMED		11	\$	4.80
10007565	PACKING, PREFORMED	Service Item	1	\$	4.00
10007775	SCREW, THD PAN HEAD TYPE BT		1	\$	2.80
10007834	NIPPLE, REDUCING		1	\$	12.30
10007842	PIN, SPIRAL	Service Item	1	\$	1.60
10007861	LABEL, COVER, REGULATOR		1	\$	4.20
10007862	PLATE, IDENTIFICATION		1	\$	2.50
10007874	PLATE, RETAINER, BODY	Service Item	1	\$	5.40
10007881	EZ FLO DIAPHRAGM RETANING RING		1	\$	6.60
10007884	SPRING, POSITIVE PRESSURE		1	\$	1.60
10007892	PLATE, SUPPORT		1	\$	21.50
10007893	BRACKET, PLATE, SUPPORT		1	\$	9.00
10007895	PRIMER, LOCTITE**	Service Item	1	\$	76.09
10007896	LUBRICANT, "O" RING		1	\$	33.47
10007997	NOSECLIP		1	\$	2.00
10008002	CLIP, BELT		1	\$	3.60
10008005	SOCKET		1	\$	107.00
10008033	HANSEN HK PLUG, 1/4" ID		1	\$	23.20
10008068	FRAME, SCOTT-O-VISTA/AV2000		1	\$	13.60
10008103	RETAINER, FRAME		1	\$	4.40
10008146	TIE, CABLE		1	\$	2.10
10008196	BOOT, LATCH PLATE	Service Item	1	\$	3.10

10008206	SOV FACEPIECE LABEL		1	\$	1.70
10008212	BAG, PLEATED		1	\$	1.80
10008221	RETAINER, BAG-BELT CLIP		1	\$	1.80
10008234	PLUG & HOSE FITTING ASSY		1	\$	53.00
10008235	SOCKET & HOSE FITTING ASSY		1	\$	77.00
10008244	LABEL,IDENT. E-Z FLO REG		1	\$	2.40
10008382	DECAL EAGLE		1	\$	2.90
10008383	DISC, NOSECUP VALVE (5-1-1081)		1	\$	4.00
10008398	RING, RETAINING, NOSE CUP		1	\$	4.00
10008400	DUCT, VOICEMITTER		1	\$	8.50
10008401	SEAL,ADPT,NSECUP(NON-SALEABLE)		5	\$	2.20
10008451	WASHER, ANTI-ROTATION (QTY 10)		11	\$	1.60
10008475	VALVE, INHALATION		1	\$	3.60
10008492	SCREW, SEAL		1	\$	2.50
10008522	HEAD HARNESS 5 STRAP		1	\$	68.40
10008531	CAP, DUST		1	\$	24.90
10008532	LATCH		1	\$	6.20
10008535	STRAP,GAUGE RETAINING		1	\$	4.50
10008536	SUPPORT, WAIST		1	\$	111.30
10008537	TIP, FLAT-VINYL		1	\$	4.40
10008538	PIN, LEVER		1	\$	4.40
10008561	LABEL, NFPA-1992 (ASC ONLY)	Service Item	1	\$	10.80
10008583	PLATE, INSTRUCTION		1	\$	5.00
10008694	LABEL, COVER, REGULATOR		1	\$	3.80
10008734	BODY, VALVE & HOSE -KB-	Service Item	1	\$	55.10
10008795	PA CONSOLE LENS		1	\$	3.76
10008796	PA LENS GASKET (10)		1	\$	9.93
10008807	CYL, HOOP WRAP 4500PSI 10 MIN		1	\$	475.00
10008817	RETAINER, CHECK VALVE **		1	\$	160.00
10008819	NIPPLE,COUPLING,PRESS REDUCER		1	\$	83.20
10008850	COVER, PLATE		1	\$	11.90
10008866	CLAMP, CYLINDER 10 MIN SKAPAK		1	\$	10.70
10008880	HOLDER, REGULATOR -KB-		1	\$	30.20
10008904	DECAL, SKA-PAK 4500 PSI		1	\$	2.00
10008912	PACKING, PREFORMED		11	\$	3.20
10008922	SLEEVE, LOW CYL. TRANSFER, 4.5	Service Item	1	\$	20.50
10008924	PACKING, PREFORMED	Service Item	1	\$	4.70
10008925	SLEEVE, LOW CYL. TRANSFER, 2.2	Service Item	1	\$	19.20
10008927	PACKING, PREFORMED	Service Item	1	\$	4.50
10008972	KIT, LOW CYL. TRANSFER, 4.5		1	\$	68.60
10008973	KIT, LOW CYL. TRANSFER, 2.2		1	\$	68.60
10008974	PA MTG,BRKT,MAIN ENCLOSURE		1	\$	12.02
10008975	PA MOTION SENSOR MTG BRKT		1	\$	12.02
10008999	PA BATTERY COVER SCREW		11	\$	2.80
10009015	SPRING, COMPRESSION **		1	\$	4.00
10009050	PA CONTROL MODULE GASKET		1	\$	2.00
10009051	PACKING, PREFORMED		1	\$	2.20
10009053	PAK ALERT PAN HEAD SCREW (10)		1	\$	2.80
10009086	SOCKET, FOSTER		1	\$	69.70
10009144	HOLDER, EYEGLASS		1	\$	9.40
10009148	BAIL, OFFSET WIRE		1	\$	3.10
10009149	BAIL, INLINE WIRE		1	\$	2.90
10009161	LATCH STRAP BACKFRAME PIN AP50		1	\$	14.70
10009191	DRIVE CAP BACKFRAME		1	\$	3.20
10009192	EDGING BACKFRAME		1	\$	22.60
10009204	WASHER		1	\$	3.30
10009205	PLATE, SUPPORT		1	\$	3.60
10009224	FRAMES, EYEGLASS		1	\$	53.00
10009225	RING, EYEGLASS SUSPENSION		1	\$	5.50
10009256	SLIDE BACKFRAME *KB*		1	\$	13.60
10009286	SCREW, SELF-LOCKING, PAN HEAD		1	\$	2.40

10009324	CARRYING BAG		1	\$	152.90
10009349	WASHER, WEAR BACKFRAME		1	\$	1.70
10009354	PAK ALERT SELF LKG NUT (10)		1	\$	1.50
10009372	SLEEVE,LOW CYL TRANSFER, 3.0	Service Item	1	\$	19.70
10009421	LABEL, APPROVAL	Service Item	1	\$	9.00
10009422	LABEL, NFPA-92 3.0		1	\$	5.70
10009427	SOCKET BUTTON HD CAP SCR-SS		1	\$	1.60
10009513	COUPLING,QUICK CHARGE MALE*KB*		1	\$	499.20
10009514	BOOT,QUICK CHARGE MALE CPLG		1	\$	64.50
10009592	*CPLG, QUICK CHARGE MALE, 4.5	Service Item	1	\$	509.60
10009593	HOSE, CHARGING WAND *KB*		1	\$	270.00
10009594	CPLG, QUICK CHARGE FEMALE, 3.0		1	\$	214.20
10009595	CPLG, QUICK CHARGE FEMALE, 4.5	Service Item	1	\$	302.60
10009598	NOSE CUP RETAIN RING(804019)		1	\$	85.70
10009601	ADAPTER, CHARGING WAND		1	\$	26.00
10009614	AP/PA HOSE CLAMP		1	\$	2.90
10009633	BRACKET, BAIL		1	\$	24.90
10009643	LABEL, SCOTT 2.2 REDUCER		1	\$	2.70
10009671	CYL,CARBON WRAP-30 MIN 4500PSI		1	\$	840.00
10009672	CYL,CARBON WRAP-60 MIN 4500PSI		1	\$	1,380.00
10009673	CYL,CARBON WRAP-45 MIN 4500PSI		1	\$	1,200.00
10009674	LATCH, HARD CASE OLD & NEW A/P		1	\$	9.00
10009675	SKA PAK CASE LATCHES		1	\$	5.50
10009705	2.2 TRANSFER VALVE*		1	\$	71.80
10009707	ISCBA MANIFOLD PN/SN LABEL**		1	\$	8.50
10009708	LABEL,P/N &SN,IND4.5 REDUCER**		1	\$	8.50
10009709	LABEL, SCOTT 4.5 REDUCER		1	\$	9.50
10009720	SKAPAK RDCR TS ADAPT**		1	\$	59.00
10009748	ALARM SEAT,IND2.2/4.5 RDR**		1	\$	40.60
10009776	BAFFLE PLATE,IND2.2/4.5 RDR**		1	\$	4.50
10009779	AV2/SOV MOLDED FACE SEAL (CS)		1	\$	47.60
10009807	AV2 EXHALATION VALVE CLAMP		1	\$	4.30
10009812	STRAP, HOOK & LOOP		1	\$	8.50
10010063	CYL,CARBON, 30MIN. 2216 PSI		1	\$	910.00
10010198	LADDER BAIL ASY WF 2.2/4.5		1	\$	35.00
10010200	BAND, CYLINDER		1	\$	20.80
10010212	FENESTRA (MOD) NAVSEA		1	\$	75.50
10010224	INSULATOR CUP (LED ALERT)		1	\$	15.00
10010227	BATTERY (3V WATCH)(LED ALARM)		1	\$	9.70
10010343	CYL,HOOP-WRAP GLASS 15MIN 3000		1	\$	320.00
10010352	COUPLING, QUICK CHARGE, 2.2		1	\$	290.20
10010449	NAVSEA 25'HOSE,CHRG WAND *KB*		1	\$	416.00
10010477	NAVSEA 10'HOSE,CHRG WAND *KB*		1	\$	230.00
10010497	SILICONE FACE SEAL, SMALL		1	\$	62.30
10010498	SILICONE FACE SEAL, LARGE		1	\$	62.30
10010499	SILICONE FACE SEAL, X-LARGE		1	\$	68.40
10010580	3.0,30MIN, CARBON CYLINDER		1	\$	1,000.00
10010636	GASKET, 40MM ADAPTER		1	\$	1.80
10010642	HEAD HARNESS, 4 STRAP		1	\$	34.70
10010666	BEARING (EZFLO PURGE BODY)		1	\$	2.80
10010667	O'RING (EZFLO PURGE BODY)		1	\$	2.80
10010684	PLATE, MOUNTING**		1	\$	7.50
10010685	CRICKET/BELL RETAINING STRAP		1	\$	3.10
10010824	SKA-PAK NIOSH LABEL FOR CYL		1	\$	9.80
10010826	CYL,CARBON 45 MIN 4500PSI S/S		1	\$	1,200.00
10010858	SILICONE FACE SEAL, (CS)		1	\$	68.40
10010906	GASKET, LED ALARM		1	\$	9.00
10010907	BOOT, LED ALARM		1	\$	7.30
10010908	BELL FOR EOST ALARM (MODIFIED)		1	\$	21.50
10010978	AVHOOD INTEGRATED SNAP & NUT		1	\$	8.50
10011011	KB NOSECUP, AV3000 SMALL		1	\$	42.90

10011012	KB NOSECUP, AV3000 MEDIUM		1	\$	42.90
10011013	KB NOSECUP, AV3000 LARGE		1	\$	42.90
10011014	KB INHALATION VALVE		1	\$	3.40
10011015	KB RETAINING RING, NOSECUP		1	\$	6.20
10011024	BEZEL, UPPER		1	\$	8.80
10011025	BEZEL, LOWER		1	\$	13.70
10011026	KB DUCT, VOICEMITTER, RIGHT		1	\$	6.80
10011027	KB DUCT, VOICEMITTER, LEFT		1	\$	6.80
10011028	PAD, BUCKLE, AV3000		1	\$	2.10
10011038	INHALATION VALVE		1	\$	6.50
10011051	GASKET, C420 PAPR SET OF TWO		1	\$	26.50
10011094	COVER, EXHAUST VALVE, XCEL		1	\$	1.90
10011095	ADJUSTER, CLIP,XCEL		1	\$	1.40
10011096	ADJUSTER, D-RING,XCEL		1	\$	1.40
10011100	PC,0-200PSIG GAUGE,STEM MNT**		1	\$	132.10
10011121	BRACKET		1	\$	11.60
10011160	SWAT/AV HOOD, BLACK NOMEX		1	\$	119.40
10011167	SWAT-PAK BACK COVER		1	\$	226.70
10011171	PLATE, INSTR., SWAT PAK		11	\$	4.00
10011195-01	DUAL EBSS RETNG STRAP,POUCH		1	\$	35.40
10011202	LENS, HI TEMP REMOTE GAUGE		1	\$	17.00
10011209	ELBOW, 1/4"NPT-F		1	\$	63.40
10011216	CARRIAGE BOLT, 1/4-20X1/2**		1	\$	2.50
10011217	NYLON INSERT LOCKNUT, 1/4-20**		1	\$	2.50
10011374	PACKING,PREFORMED		1	\$	2.30
10011490	TUBING, XCEL FIT TEST ADPT		1	\$	2.90
10011499	NIPPLE, COUPLING		1	\$	35.40
10011554	PLUG		1	\$	8.10
10011653	SCREW,PANEL,CAPTIVE,PAN HD		1	\$	4.50
10011687	SLIDE,QUARTER TURN ADAPTER		1	\$	3.10
10011688	COVER, EXHALATION VALVE		1	\$	9.40
10011690	SPRING, QUICK RELEASE SLIDE		1	\$	1.70
10011745	QD PLUG (FOSTER)		1	\$	54.00
10011747	QD PLUG (CEJN)		1	\$	81.00
10011748	QD SOCKET (CEJN)		1	\$	103.00
10011775	DIAPHRAM SHROUD		1	\$	4.50
10011784	LABEL,REGULATOR COVER		1	\$	2.70
10011882	TACTICAL CARRIER, MASK BAG M95		1	\$	76.50
10012062	SEAL SILICONE,6 PIN,QD CONNECT		1	\$	3.50
10012121	SIZING DISC., SMALL, AV3000		12	\$	1.70
10012122	SIZING DISC., MEDIUM,AV3000		12	\$	1.70
10012123	SIZING DISC.,LARGE, AV3000		12	\$	1.70
10012126	LABEL, SIZING, FACEPIECE		31	\$	0.50
10012127	MANIFOLD, QUICK DISCONNECT		1	\$	41.60
10012128	Q D,MALE,CHECKED *KB*		1	\$	223.60
10012129	Q D,FEMALE,CHECK *KB*		1	\$	190.30
10012133	SCREW,SEAL,PANHD,SELF-TAP,AB		1	\$	3.25
10012151	TACTICAL CARRIER,SHDR STRP M95		1	\$	21.10
10012152	TACTICAL CARRIER,LEG STRP M95		1	\$	12.80
10012157	PIN, LATCH LOCK		1	\$	26.20
10012162	SEAL, SWITCH CONTACTS		11	\$	2.30
10012167	COVER, SWITCH		1	\$	2.30
10012168	SEAL, SWTICH COVER		1	\$	3.40
10012169	DISC,NIPPLE		1	\$	23.80
10012175	WASHER, SWIVEL		1	\$	2.40
10012176	SCREW, LOCK		1	\$	2.30
10012207	PROBE, 4500 PSI		1	\$	86.30
10012208	PROBE, 2216 PSI		1	\$	83.20
10012218	NOSECUP, AV3000 X-LARGE		1	\$	42.90
10012222	LABEL, ALKALINE BATTERY HLDR		1	\$	5.50
10012298	SPRING, PISTON	Service Item	1	\$	27.00

10012299	SPRING, SEAL RETAINER		1	\$	7.70
10012304	SPRING, COMPRESSION		1	\$	7.90
10012311	SPRING, COMPRESSION		1	\$	2.30
10012346	EEOSTI BATTERY COVER		1	\$	8.30
10012361	LABEL,NIOSH,AIR-PAK NXG2		1	\$	3.45
10012376	CABLE ASSY,PRESSURE REDUCER		1	\$	74.90
10012395	MTG BRKT, DISPLAY HOUSING		1	\$	4.80
10012416	ELECTRONIC ENCLOSURE		1	\$	74.90
10012417	COVER, ELECTRONICS ENCLOSURE		1	\$	32.20
10012418	ELECTRONIC ENCLOSURE,GASKET		1	\$	7.20
10012421	PC CABLE, BASE UNIT		1	\$	183.92
10012422	SEMS USER PROG SOFTWARE		1	\$	155.71
10012424	SOUND CHAMBER		1	\$	23.80
10012457	SCREW,CAPTIVE,PAN HD,SEMS/EMS		1	\$	2.30
10012484	CYL,CARB,FULL WRAP 5 MIN 3.0		1	\$	410.00
10012485	CYL,CARB,FULL WRAP 10 MIN 3.0		1	\$	410.00
10012488	WAIST TO SHOULDER STRAP *KB*		1	\$	73.80
10012512	LABEL,ELSA 5,NIOSH APPROVAL		1	\$	6.00
10012515	MOUNTING BRACKET, MOTION SENS		1	\$	17.00
10012516	SCREW,FILLISTER HD,3MMX10MM PT		1	\$	1.60
10012533	PIEZO, W/CONNECTOR		1	\$	27.00
10012535	LABEL,NFPA-2002,AIR-PAK NXG2		1	\$	7.65
10012546	EBSS, QUARTER POST	Service Item	1	\$	18.20
10012566	CYL ALUM 5 MIN HF & 10 MIN 3.0		1	\$	200.00
10012567	CYLINDER, ALUM 5 MIN 2216 PSI		1	\$	165.00
10012574	CBRN BACK FRAME LABEL		1	\$	4.80
10012602	VISOR, DISPLAY		1	\$	6.60
10124-00	BAG-PROTECTIVE		1	\$	3.60
1017290	BUCKLE LADDER		1	\$	36.00
1017390	CATCH BUTTON,RET & SCREWS (X2)		1	\$	45.00
1017401	CAM LOCK CATCH BASE ASSY		1	\$	58.00
1017795	CLIP, WHISTLE, ACS		1	\$	44.00
1017796	WHISTLE CLIP,SPARES (2) PACK		1	\$	44.00
1017797	U CLIP, LP FOR CN		1	\$	9.00
1017800	U-CLIP,SPARES (5) PACK		1	\$	43.00
1017801	U-CLIP,HIGH PRESS FOR CN		1	\$	9.00
1017803	U-CLIP,HIGH PRESS,SPARES (5)PK		1	\$	43.00
1018582	RETAINER FOR U CLIP CTR		1	\$	42.00
1018590	HANDWHEEL, 4500 PSI, ACS		1	\$	97.00
1018591	HANDWHEEL, 2216 PSI, ACS		1	\$	97.00
1018919	BLANK PLUG & O-RING,SPARES PK		1	\$	49.00
1018923	PLUG, BLANK, LP, ACS		1	\$	21.00
1019688	CYL BAND COMP ASSY,KEVLAR		1	\$	205.00
1021536	TAMPERPROOF SCREWS,SPARES(5)PK		1	\$	41.00
1021904	WASHER, WHISTLE, ACS		1	\$	11.00
1021905	NYLON WASHER,SPARES (5) PACK		1	\$	47.00
1021935	WASHER, LOCK, ACS		1	\$	9.00
1022061	FILTER, SINTERED, ACS REDUCER		1	\$	31.00
1022064	SINTERED FILTER,SPARES (2) PK		1	\$	60.00
1023213	BODY, WHISTLE, ACS		1	\$	210.00
1023216	WHISTLE BODY ONLY, SPARE		1	\$	140.00
1023220	WHISTLE FLUTE & PLUG		1	\$	63.00
1023238	NUT, WHISTLE FLUTE, ACS		1	\$	35.00
1023239	LOCKNUT,SPARES (2) PACK		1	\$	45.00
1023242	BLANK PLUG & O-RING		1	\$	53.00
1023391	COVER, GAUGE, ACS		1	\$	48.00
1023392	GAUGE SHROUD ONLY		1	\$	48.00
1023409	BUNG FOR PRESSURE GAUGE		1	\$	40.00
1024819	HOSE ASSY,CONTOUR/PATHFINDER		1	\$	220.00
1025881	O-RING LUBE, ACS		1	\$	115.00
1027409	LABEL "POS PRESSURE"SPARES(5)		1	\$	40.00

1027769	O-RING, ACS		1	\$	9.00
1027770	CONNECTOR O-RING, SPARES (5)PK		1	\$	38.00
1027818	BONDED SEAL 1/4 BSP		1	\$	22.40
1027830	BYPASS O-RING, SPARES (5) PACK		1	\$	38.00
1027892	O-RING, ACS		1	\$	33.00
1027893	CONNECTOR O-RING SPARES (5)PK		1	\$	38.00
1027934	SEAL, WHISTLE, ACS		1	\$	21.00
1027937	CRUSH SEAL, SPARES (5) PACK		1	\$	99.00
1027985	O-RING, ACS		1	\$	9.00
1027986	O-RING, SPARES (5) PACK		1	\$	38.00
1028002	O-RING, SPARES (5) PACK		1	\$	43.00
1028043	O-RING, SPARES (5) PACK		1	\$	41.00
1028048	SEAL, ACS		1	\$	50.00
1028049	WHISTLE SEAL, SPARES (5) PACK		1	\$	165.00
1028286	O-RING, ACS		1	\$	9.00
1028288	O-RING, REDUCER PISTON, ACS		1	\$	42.00
1028289	O-RING, REDUCER, ACS		1	\$	31.00
1028416	BIAS SPRING, SPARES (5) PACK		1	\$	58.00
1028417	SPRING, PISTON, ACS		1	\$	45.00
1028418	SPRING		1	\$	45.00
1028432	CATCH SPRING SPARES (5) PACK		1	\$	38.00
1028856	VALVE DISC, SPARES (2) PACK		1	\$	120.00
1028880	RESET BUTTON, SPARES (2) PACK		1	\$	40.00
1028982	CATCH & SPRING SPARES PACK		1	\$	41.00
1029051	BYPASS KNOB		1	\$	44.00
1029105	REG BODY & PILOT JET ASSY		1	\$	70.00
1029112	REGULATOR COVER		1	\$	54.00
1029171	RETAINER DISC FOR FBM, SPARES(5		1	\$	36.00
1029173	SEC DIAPHRAGM, SPARES (5) PACK		1	\$	170.00
1029418	PISTON SEAT, ACS		1	\$	9.78
1029421	PISTON SEAT, SPARES (5) PACK		1	\$	45.00
1029425	COVER & SCREWS, SPARES PACK		1	\$	43.00
1029595	PISTON & SEAT ASSEMBLY (2)		1	\$	100.00
1029603	PRV & O-RING ASSEMBLY		1	\$	60.00
1029616	FIRST STAGE REDUCER BODY		1	\$	280.00
1029675	PISTON O-RING & PRV ASSY		1	\$	93.00
1029704	FIRST STAGE REDUCER CAP		1	\$	89.00
1030071	TOP, REDUCER, ACS		1	\$	89.00
1030085	PISTON ASSY, RED, ACS, SPARE		1	\$	93.00
1032105	EXHALATION VALVE W/O-RING NIOS		1	\$	36.40
1032238	FRONT COVER & SCREWS, SPARES		1	\$	44.00
1032379	SIDE FITTING INCLUDING DEFLECT		1	\$	47.00
1032384	DEFLECTOR FOR SIDE FITTING		1	\$	38.00
1033315	HEAD HARNESS POLY NET		1	\$	225.00
1033545	PROT CAP FOR REG OUTLET		1	\$	57.00
1033779	C-100 TOOLKIT		1	\$	1,030.00
1033987	TOOL, PISTON SEAT, ACS REDUCER		1	\$	13.00
1033999	TOOL, CAP, ACS REDUCER		1	\$	57.00
1034526	LOCTITE 542 HYDRAULIC SEALANT		1	\$	80.00
1038429	HOSE RETAINER (PACK 5)		1	\$	78.00
13160-01	CLAMP (WWD 152)		1	\$	15.90
13435-00	SOCKET & HOSE CLAMP ASSY		1	\$	78.00
13436-00	PLUG&HOSE CLAMP ASSY		1	\$	30.00
13870-00	VALVE, EXHALATION		1	\$	6.50
13944-00	CAPLUG 5&8 SC		1	\$	1.10
14403-01	RING, RETAINING		1	\$	3.30
14492-01	PLUG ASSY		1	\$	85.00
14575-00	FITTING HOSE		1	\$	22.40
1500039	LABEL, NFPA 1981 2002 ED		1	\$	8.10
1500061	SCREW, 4-40 UNDERCUT FLAT HD		1	\$	2.50
1500100	SCREW, FLAT SOCKET CAP 10-32 NF		1	\$	1.35

1500117	PLUG, CHECK, FLUSH		1	\$	8.10
1500123	CAP,DUST,DUAL DISCONNECT		1	\$	25.00
1500133	LABEL, UPGRADE,NFPA 2002		11	\$	6.00
15423-00	HANSEN PLUG		1	\$	13.60
15423-01	COUPLING		1	\$	3.50
15424-00	SCHRADER PLUG		1	\$	20.50
15424-01	ADAPTER		1	\$	27.00
15435-00	PLUG & CLAMP		1	\$	51.00
18002-00	PACKING,PREFORM .07W X .364 ID		1	\$	4.80
18012-00	PACKING,PREFORM .07W X .489 ID		1	\$	5.40
18013-00	PACKING,PREFORMED		1	\$	5.00
18021-00	PACKING-PREFORM .07W X.426ID		1	\$	4.80
18024-00	PACKING PREFORMED		1	\$	3.50
18053-00	PACKING,PREFORM .07W X .301 ID		1	\$	5.40
18057-00	2800C28A O RING		1	\$	3.80
18062-00	PACKING,PREFORM .07W X .926 ID		1	\$	4.80
18070-00	PACKING,PREFORM .07W X.114ID		1	\$	4.50
18071-00	RETAINER,PACKING		1	\$	3.30
18071-01	ORING,SNGL TRN(RED2.2/4.5)**		5	\$	1.20
18071-02	ORING,SNGLTRN(PRED/HSE CPLG)		1	\$	1.20
18071-05	RETAINER,PACK,ST,POLYTETRAFLOU		1	\$	1.10
18091-00	PACKING-PREFORM .301ID X.064DI		1	\$	2.80
18099-00	PACKING-PREFORM .070W X.551ID		1	\$	5.20
19003-00	PACKING,PREFORM .07W X .676ID		1	\$	3.10
19457-00	SOCKET		1	\$	80.00
19458-00	SOCKET		1	\$	80.00
19486-00	PACKING-.125OD X.239 ID X.064		1	\$	3.10
19889-00	SOCKET		1	\$	65.00
19966-00	PACKING,PREFORM .07W X 1.114ID		1	\$	4.80
200015-04	NXG2 DUAL,EBSS/EXDUR HOSEPOUCH		1	\$	785.20
200015-05	DUAL,EBSS/EXDUR HOSE&POUCH 50		1	\$	785.20
200015-09	DUAL COUPLING,EBSS ASSY, LH		1	\$	785.20
200015-16	DUAL COUPLING,EBSS ASY,WF,FFSR		1	\$	755.00
200015-19	DUAL COUPLING,EBSS ASY,AP,FFSR		1	\$	755.00
200016-01	HOSE W/HUD & PLUG DISC *KB*		1	\$	363.00
200016-02	SWIVEL HOSE W/HUD *KB*		1	\$	428.50
200016-03	SWIVEL HOSE W/HUD NXG2 *KB*		1	\$	545.00
200017-01	HUD HOSE & SOCKET ASSY *KB*		1	\$	454.50
200019-01	PCB ASSEMBLY, EEOSTI		1	\$	79.00
200028-02	VALE ASSY, CHECK/VENT		1	\$	418.10
200030-01	VALVE, TRANSFER, MOLDED		1	\$	40.00
200031-03	REDUCER ASSY, SKA-PAK AT		1	\$	560.00
200031-04	REDUCER ASSY, SKA-PAK AT		1	\$	560.00
200035-01	HOUSING, EEOSTI, COATED		1	\$	27.00
200036-01	ASSY,EEOSTI,WITH LINE 2.2 PSI		1	\$	590.00
200036-02	ASSY,EEOSTI, WITH LINE 4.5 PSI		1	\$	590.00
200036-03	ASSY,EEOSTI, WITH LINE 3.0 PSI		1	\$	590.00
200036-04	ASSY,EEOSTI WITH LINE A/T 2.2		1	\$	590.00
200036-05	ASSY,EEOSTI, WITH LINE A/T 3.0		1	\$	590.00
200036-06	ASSY,EEOSTI, WITH LINE A/T 4.5		1	\$	590.00
200036-08	GAUGE & LINE ASY,AT,MD,3.0		1	\$	590.00
200048-01	RIC UAC ASSEMBLY KIT		1	\$	872.60
200048-03	RIC UAC ASSEMBLY KIT		1	\$	872.60
200056-01	2002 UPGRADE KIT 2216 STD HOSE		1	\$	1,640.00
200056-04	2002 UPGRADE KIT 2216 QD HOSE		1	\$	1,820.00
200056-05	HUD CONTROL ASSY 3000 PSI		1	\$	1,640.00
200056-08	2002 UPGRADE KIT 3000 QD HOSE		1	\$	1,820.00
200056-09	2002 UPGRADE KIT 4500 STD HOSE		1	\$	1,640.00
200056-12	2002 UPGRADE KIT 4500 QD HOSE		1	\$	1,800.00
200058-01	MANIFOLD ASSEMBLY** SC ONLY		1	\$	450.00
200058-02	MANIFOLD ASSEMBLY SC ONLY		1	\$	486.70



200059-01	INLET/LATCH ASSEMBLY		1	\$	496.10
200059-02	INLET/LATCH ASSEMBLY		1	\$	496.10
200060-01	4.5 REDUCER ASSEMBLY		1	\$	2,150.00
200070-01	TRC-1 CART W/HANSEN FITTINGS		1	\$	5,860.00
200070-02	TRC-1 CART W/FOSTER FITTINGS		1	\$	5,990.00
200070-03	TRC-1 CART W/HANSEN HK FTGS		1	\$	6,310.00
200070-04	TRC-1 CART W/SCHRADER FITTINGS		1	\$	5,890.00
200070-05	TRC-1 CART W/CEJN FITTINGS		1	\$	6,180.00
200071-01	PCB ASSEMBLY, NXG2 SCT CONSOLE		1	\$	502.30
200071-02	PCB ASSEMBLY, NXG2 SEMS CONSOL		1	\$	424.27
200071-03	PCB ASSEMBLY, NXG2 GAUGE ONLY		1	\$	502.30
200077-01	REG ASY,EZ FLO+,STD HOSE		1	\$	1,010.00
200077-02	REG ASY,EZ FLO+,QD HOSE		1	\$	1,010.00
200077-05	REG ASY,EZ FLO+,SWAT QD HOSE		1	\$	1,010.00
200077-10	REG ASY,EZ FLO+,HUD QD HOSE		1	\$	1,410.00
200077-11	REG ASY,EZ FLO+HUD LONG HOSE		1	\$	1,410.00
200077-15	EZ FLO+ REG ASSY L/LOW PRE HSE		1	\$	964.10
200077-18	REG ASY,EZ FLO+,SWAT HUD QD		1	\$	1,410.00
200077-19	REG ASY.EZ FLO+,HUD NXG7 HOSE		1	\$	1,358.00
200077-30	REG ASY,EZ FLO+		1	\$	1,510.00
200077-31	REG ASY,EZ FLO+		1	\$	1,510.00
200077-50	REG ASY, 2013, QD		1	\$	1,500.00
200077-51	REG ASY, 2013, LH AP		1	\$	1,500.00
200077-57	REG ASY, 2013, LH X3 SNAP		1	\$	1,500.00
200077-58	REG ASY, 2013, LH X3 CGA		1	\$	1,500.00
200077-59	REG ASY, 2013, LH NXG		1	\$	1,500.00
200083-01	DIAPHRAGM & VALVE ASSY,EZ FLO+		1	\$	219.40
200092-01	PCB ASSMBLY,RELAY,EAGLE IMAGER		1	\$	66.00
200095-01	WAIST PAD ASSEMBLY		1	\$	417.00
200095-02	ASSY,PAD,WAIST		1	\$	188.20
200097-01	SHOULDER STRAP ASSY		1	\$	157.00
200097-02	ASSY,STRAP,SHOULDER		1	\$	157.00
200098-01	SHOULDER PAD-STRAP ASSY		1	\$	623.00
200098-02	ASSY,PAD-STRAP,SHOULDER		1	\$	593.80
200100-02	UPGRADE KIT, 3000 SKA PAK AT		1	\$	1,530.00
200112-01	CHECK ADAP ASY,EXT DUR,HANSEN		1	\$	303.70
200112-02	CHECK ADAP ASY,EXT DUR,FOSTER		1	\$	303.70
200112-03	CHECK ADAP ASY,EXT DUR,HAN HK		1	\$	303.70
200112-04	CHECK ADAP ASY,EXT DUR,SCHRAD		1	\$	303.70
200116-01	ASSEMBLY,CYLINDER RETENTION		1	\$	140.40
200116-02	ASSEMBLY,CYLINDER RETENTION		1	\$	140.40
200116-03	ASSEMBLY,CYL RET. SERVICE KIT		1	\$	140.40
200116-04	ASSEMBLY,CYL RET. SERVICE KIT		1	\$	170.00
200116-07	ASSEMBLY,AP75 CYL RETENTION		1	\$	135.00
200117-01	ASSMBY, CYLINDER LATCH HANDLE		1	\$	37.00
200119-01	EZ RADIOII MASK VOICE AMP ONLY		1	\$	767.03
200119-01H	EZ RADIOII HOUSTON		1	\$	953.04
200119-103	EZ RADIOCOM II		1	\$	1,544.51
200119-104	EZ RADIOCOM II		1	\$	1,544.51
200119-117	EZ RADIOCOM II		1	\$	1,567.50
200119-134	EZ RADIOCOM II		1	\$	1,544.51
200119-168	EZ RADIOCOM II		1	\$	1,544.51
200119-171	EZ RADIOCOM II		1	\$	1,544.51
200119-192	EZ RADIOCOM II		1	\$	1,286.40
200119-195	EZ RADIOCOM II		1	\$	1,544.51
200119-501	EZ RADIOCOM II		1	\$	2,194.50
200119-502	EZ RADIOCOM II		1	\$	2,099.41
200123-01	BOTTLE SWITCH ASSEMBLY,NXG		1	\$	23.80
200125-01	BACKFRAME SUB ASSY, NXG2		1	\$	1,890.00
200126-104	EZ RADIOCOM II		1	\$	627.00
200126-501A	EZ RADIOCOM II,CABLE ASSEMBLY		1	\$	709.56

200126-501B	EZ RADIOCOM II,CABLE ASSEMBLY		1	\$	442.04
200126-501C	EZ RADIOCOM II,CABLE ASSEMBLY		1	\$	437.86
200127-02	NXG2 GAUGE ASSY,4500 PSI		1	\$	1,691.00
200128-01	CYL&VALV ASSY CARB,30MIN,4500		1	\$	1,000.00
200128-01-1	CYL&VALV ASSY CARB,30MIN,4500		1	\$	1,000.00
200128-01-D	CYL&VALV ASSY CARB,30MIN,4500		1	\$	1,000.00
200128-11	CYL&VALV ASSY CARB,30MIN,4500		1	\$	1,100.00
200129-01	4.5-45MIN CARB CYL&VLV NXG		1	\$	1,370.00
200129-01-1	CYL&VALV ASSY CARB,45MIN,4500		1	\$	1,370.00
200129-01A	CARBON & VALVE ASY,45MIN 4500		1	\$	1,370.00
200129-01A-1	CYL&VALV ASSY CARB,45MIN,4500		1	\$	1,370.00
200129-01A-D	CYL&VALV ASSY CARB,45MIN,4500		1	\$	1,370.00
200129-01-D	CYL&VALV ASSY CARB,45MIN,4500		1	\$	1,370.00
200129-11	CYL&VALV ASSY CARB,45MIN,4500		1	\$	1,370.00
200130-01	4.5-60MIN CARB CYL&VLV NXG		1	\$	1,530.00
200130-01-1	CYL&VALV ASSY CARB,60MIN,4500		1	\$	1,530.00
200130-01-D	CYL&VALV ASSY CARB,60MIN,4500		1	\$	1,530.00
200130-11	CYL&VALV ASSY CARB,60MIN,4500		1	\$	1,610.00
200131-01	CYL&VLV ASSY CARB,30MIN,2216		1	\$	1,120.00
200131-01-1	CYL&VALV ASSY CARB,30MIN,2216		1	\$	1,120.00
200131-01-D	CYL&VALV ASSY CARB,30MIN,2216		1	\$	1,120.00
200132-01	HOSE ASSY W/SKT QD,NXG2 *KB*		1	\$	476.30
200132-02	HOSE ASSY W/SKT QD,NXG2		1	\$	476.30
200132-03	QD HOSE ASSY,NXG7, ANTI-ROTATI		1	\$	485.00
200133-01	ADAPTER CABLE ASSY		1	\$	74.00
200145-01	HOSE ASSY, MANIFOLD		1	\$	84.20
200145-02	HOSE ASSY, MANIFOLD		1	\$	162.20
200145-04	HOSE ASSY, MANIFOLD		1	\$	68.60
200149-01	BATTERY HOLDER ASSEMBLY		1	\$	225.00
200149-02	BATTERY HOLDER ASSEMBLY		1	\$	225.00
200150-01	UNIVERSAL CHARGING WAND ASSY		1	\$	1,110.00
200150-03	UNIVERSAL CHARGING WAND		1	\$	1,580.00
200154-04	REG ASSY,EZ FLO+QD NON-NFPA SW		1	\$	1,410.00
200158-01	ASSY,BATTERY, EI,BAE-SERIES		1	\$	158.00
200159-01	HAND STRAP ASSY,TI CAMERA		1	\$	29.00
200162-01	HOSE ASY W/SOCK DISCON,HUD,SWA		1	\$	366.10
200168-01	SUB-ASSEMBLY,HUD HOSE QD		1	\$	382.70
200168-02	SUB-ASSEMBLY,HUD HOSE, LONG		1	\$	448.20
200168-03	SUB-ASSEMBLY HUD HOSE NXG2		1	\$	445.00
200170-02	DUAL COUP EBSS RETROFIT KIT		1	\$	823.70
200170-03	DUAL COUP EBSS RETROFIT KIT		1	\$	823.70
200170-04	DUAL COUP EBSS RETROFIT KIT		1	\$	823.70
200170-12	DUAL COUP EBSS RETROFIT KIT		1	\$	865.30
200173-01	CBRN '97 SCBA RETRO KIT - STD		1	\$	1,040.00
200173-03	CBRN '97 SCBA RETROFIT KIT		1	\$	1,410.00
200173-15	CBRN 2002 SCBA RETROFIT KIT		1	\$	1,040.00
200174-01	SERVICE HOSE ASSY *SC ONLY		1	\$	471.10
200176-01	FLOW RESTRICTOR ASSY		1	\$	68.60
200177-01	HEAD HARN ASSY 6 ST, RUBBER		1	\$	82.50
200184-01	PCB ASSEMBLY, EI TCS		1	\$	62.00
200185-02	HANDLE POWER CABLE ASM		1	\$	95.00
200187-01	HUD DRIVER MODULE ASSY,2216PSI		1	\$	702.00
200187-02	HUD DRIVER MODULE ASSY,3000PSI		1	\$	702.00
200187-03	HUD DRIVER MODULE ASSY,4500PSI		1	\$	702.00
200188-02	HSG ASY, HUD DRIVER MODULE		1	\$	166.40
200188-03	HSG ASY, HUD DRIVER MODULE		1	\$	166.40
200188-04	HSG ASY, HUD DRIVER MODULE		1	\$	166.40
200189-01	BATTERY COVER ASSEMBLY		1	\$	18.20
200190-01	TRANSDUCER AND HOUSING ASSY		1	\$	340.10
200191-01	MANIFOLD ASSY, HUD		1	\$	109.20
200194-05	KIT ASY HDWRE NAVSEA		1	\$	196.60

200194-06	KIT,ASSY,HDWR, AP FIFTY-I		1	\$	49.90
200196-01	SCOTT TALK-AROUND,PHOENIX		1	\$	2,007.45
200197-01	KIT,DUAL COUP EBSS,POUCH		1	\$	217.40
200197-02	KIT,DUAL COUP EBSS,POUCH		1	\$	217.40
200199-01	EI160 CARRYING CASE		1	\$	956.00
200204-10	REG ASY EZ FLO II+		1	\$	1,490.00
200204-14	MMR W/PLATE,HUD & QD		1	\$	1,520.00
200204-16	REG ASSY EZ FLO II+		1	\$	1,490.00
200204-30	REG ASY EZ FLO II+		1	\$	1,490.00
200204-31	REG ASY EZ FLO II+		1	\$	1,490.00
200206-02	EAGLE IMAGER 160 SERVICE KIT		1	\$	6,737.00
200208-01	EAGLE 160 TI CAMERA TCS		1	\$	818.00
200210-01	ASSEMBLY,HOSE,TEST *SC ONLY		1	\$	89.40
200211-01	KIT,INH VLV XCEL		1	\$	12.70
200213-01	BATTERY HOLDER ASSEMBLY		1	\$	52.00
200215-01	CAMERA CONTACT ASSEMBLY		1	\$	108.00
200218-01	BUTYL PAPER HOOD ASSY,SMALL		1	\$	354.00
200218-02	BUTYL PAPER HOOD ASSY,LARGE		1	\$	354.00
200219-01	AV-3000 NBC SHROUD KIT		1	\$	275.40
200220-01	HUD ASY,2216 PSI QD REG HOSE		1	\$	1,403.00
200220-02	HUD ASY,2216 PSI STD REG HOSE		1	\$	1,070.00
200220-03	HUD ASY,3000 PSI QD REG HOSE		1	\$	1,403.00
200220-04	HUD ASY,3000 PSI STD REG HOSE		1	\$	1,070.00
200220-05	HUD ASY,4500 PSI QD REG HOSE		1	\$	1,403.00
200220-06	HUD ASY,4500 PSI STD REG HOSE		1	\$	1,070.00
200220-22	HUD DRIV MOD 2216 W/MTG HDWRE		1	\$	577.20
200220-45	HUD DRIV MOD 4500PSI W/MTG HDW		1	\$	577.20
200221-01	BATTY SHIELD ASY,EI160 TCS		1	\$	26.00
200225-01	KIT,HOSE,POSI-CHEK,NXG2/NXG7		1	\$	292.20
200226-01	CAMERA PROGRAMMING ADAPTER		1	\$	421.00
200233-01	GERMANIUM LENS REPLACEMENT KIT		1	\$	423.00
200235-01	EI160 TCS,12 VDC,TOP LEVEL ASY		1	\$	870.45
200235-02	EI160 TCS 110VAC TOP LEVEL ASY		1	\$	880.95
200237-01	POUCH, EBSS, FLAP, LH		1	\$	144.60
200237-03	POUCH, EBSS, FLAP, LH, NO LOOP		1	\$	138.00
200241-01	EAGLE 'X' CASE ASSEMBLY		1	\$	825.00
200242-01	EAGLE X CORE ASSY PROG NO TEMP		1	\$	6,783.00
200242-05	EAGLE X CORE ASSY PROG DIGIT C		1	\$	6,783.00
200244-01	EAGLE 'X' TRK MT BATTERY CHRGR		1	\$	491.00
200244-02	EAGLE 'X' TRK MT BATTERY CHRGR		1	\$	470.00
200245-101	REGULAR PTT		1	\$	2,058.65
200246-01	OVERLAY KIT, HUD DISPLAY		1	\$	234.00
2002510	LUMBAR PAD		1	\$	81.00
200262-12	EPIC RI LAPEL MIC ASSEMBLY		1	\$	1,390.90
200262-14	EPIC RI LAPEL MIC ASSEMBLY		1	\$	1,098.30
200262-15	EPIC RI LAPEL MIC ASSEMBLY		1	\$	1,178.76
200262-18	EPIC RI LAPEL MIC ASSEMBLY		1	\$	1,178.76
200262-19	EPIC RI LAPEL MIC ASSEMBLY		1	\$	1,178.76
200262-22	EPIC RI LAPEL MIC ASSEMBLY		1	\$	1,275.95
200266-04	HHR ASSEMBLY,PAK-TRACKER		1	\$	1,575.00
200267-01	PT ASSEMBLY,PAK-TRACKER		1	\$	317.68
200270-01	GAUGE LINE ASSEMBLY		1	\$	93.60
200270-02	GAUGE LINE ASSEMBLY		1	\$	104.00
200270-03	GAUGE LINE ASSEMBLY		1	\$	155.00
200270-11	GAUGE LINE W/ELBOW		1	\$	155.00
200274-01	BACKFRAME ASSEMBLY		1	\$	438.90
200275-01	BACK-PAK ASSEMBLY		1	\$	1,290.00
200275-02	BACK-PAK ASSEMBLY		1	\$	1,290.00
200280-01	CONSOLE ASSY, HUD VERSION 200		1	\$	1,612.00
200280-02	CONSOLE ASSY, HUD VERSION 200		1	\$	1,060.00
200285-01	4.5 PRESSURE REDUCER		1	\$	1,940.00

200286-01	CYL VLV SEAL KIT		1	\$	48.90
200296-01	BATTERY CAP ASSEMBLY		1	\$	33.30
200297-01	ASSY, MANIFOLD		1	\$	125.00
2003468	ADPT-5 FOR PANASEAL(LQF/FQF)		1	\$	255.00
200354-01	GAUGE LINE ASSY, NXG2**	Service Item	1	\$	270.40
200354-02	GAUGE LINE ASSY, NXG2**	Service Item	1	\$	265.20
200354-04	GAUGE LINE ASSY, NXG2		1	\$	385.60
200355-01	RECEPT ASSY W/CONNECTOR		1	\$	32.20
200356-01	BATTERY CABLE ASSEMBLY		1	\$	27.00
200370-01	BOOT, ASSEMBLY		1	\$	32.00
200371-52F	LENS KIT, 52MM FRAMES ONLY		1	\$	122.40
200371-60F	LENS KIT, 60MM FRAMES ONLY		1	\$	122.40
200372-52F	LENS KIT, 52MM FRAMES ONLY		1	\$	122.40
200372-60F	LENS KIT, 60MM FRAMES ONLY		1	\$	122.40
200373-52F	LENS KIT, 52MM FRAMES ONLY		1	\$	122.40
200373-60F	LENS KIT, 60MM FRAMES ONLY		1	\$	122.40
200374-54F	LENS KIT, 54MM FRAMES ONLY		1	\$	122.40
200378-04	HAZMAT RADIOCOM II		1	\$	1,102.48
200379-01	POUCH, EBSS, FLAP, RH		1	\$	106.10
200388-01	TOOL ADAPTER		1	\$	474.20
200394-01	REDUCER ASY W/POPPET VALVE		1	\$	173.70
200402-02	BATTERY ASSEMBLY, SSR		1	\$	95.00
2004032	MAIN DIAPHRAGM		1	\$	87.00
2004044	EXHALE VALVE ASSY		1	\$	74.00
2004047	PRV ASSY, RED, ACS, SPARE		1	\$	46.00
200411-01	LANYARD ASSY, PAK-TRACKER		1	\$	29.26
200412-02	FLANGE ASSY PASS-THRU		1	\$	240.00
200423-01	ADAPTER, CBRN 40MM		1	\$	57.40
200424-01	CONSOLE ASSY, PASS VERSION 200		1	\$	1,160.00
200424-02	CONSOLE ASSY, PASS VERSION 200		1	\$	1,160.00
200424-03	CONSOLE ASSY, PASS VERSION 200		1	\$	1,160.00
200424-04	CONSOLE ASSY, PASS VERSION 200		1	\$	1,160.00
200431-01	BATTERY DOOR ASSY, PAK-TRACKER		1	\$	43.89
200433-01	TRK MT CHARGER,PAK-TRACKER		1	\$	504.74
200433-02	TRK MT CHARGER,PAK-TRACKER		1	\$	550.72
200434-01	DESK TOP CHR G ASSY,PAK-TRACKER		1	\$	494.29
200437-01	2.2 PRESSURE RED. ASSEMBLY		1	\$	1,200.00
200438-01	4.5 PRESSURE RED. ASSEMBLY		1	\$	1,200.00
200439-01	RELIEF VALVE ASSEMBLY	Service Item	1	\$	194.50
200440-01	COVER ASSY, PRESSURE REDUCER	Service Item	1	\$	321.40
200441-01	GAUGE LINE HOUSING ASSEMBLY	Service Item	1	\$	36.40
2004440	HEAD HARNESS		1	\$	89.00
200449-01	ASSY,REG HOSE,HUD,QD		1	\$	363.00
200449-02	ASSY,REG HOSE,HUD,LG,SWAT		1	\$	428.50
200449-03	ASSY,REG HOSE,HUD,NXG NO QD		1	\$	383.80
200450-01	ASSY HOSE,HUD SOCKET QD		1	\$	454.50
200450-03	HOSE ASSY, HUD, QD, ANTI-ROTAT		1	\$	485.00
200451-01	2007 SENSOR ASSY, AP75		1	\$	2,010.00
200451-02	TOP ASSEMBLY, SENSOR, 2007		1	\$	2,270.00
200451-03	TOP ASSEMBLY, SENSOR, 2013		1	\$	2,300.00
200451-11	TOP ASSEMBLY, SENSOR, 2007		1	\$	1,330.00
200451-12	TOP ASSEMBLY, SENSOR, 2007		1	\$	2,158.97
200453-01	HOUSING COVER ASSY, SENSOR		1	\$	34.49
200455-02	BATTERY PCB ASSY, 2007 SENSOR	Service Item	1	\$	71.00
200465-01	BACKFRAME ASSEMBLY		1	\$	440.00
200466-01	BACK-PAK ASSEMBLY		1	\$	1,290.00
200466-02	BACK-PAK ASSEMBLY		1	\$	1,290.00
200474-01	KIT, EBSS, AP50 & WIREFRAME		1	\$	565.80
2006541	HANDWHEEL LP		1	\$	80.00
2006543	CONNECTOR INNER CGA 346 (1)		1	\$	95.00
200657-01	VALVE ASSY,CYLINDER, JDF		1	\$	380.00

200659-01	CYL&VLV ASSY (JAPAN)		1	\$	1,760.00
200660-01	CYL&VLV ASSY (JAPAN)		1	\$	1,440.00
200662-01	MOUNTING KIT, SENSOR MODULE		1	\$	90.50
200662-02	MOUNTING KIT, SENSOR MODULE		1	\$	116.50
200662-03	MOUNTING KIT, SENSOR MODULE		1	\$	116.50
200662-04	MOUNTING KIT, SENSOR MODULE		1	\$	116.50
200662-05	MOUNTING KIT, SENSOR MODULE	Service Item	1	\$	91.50
2006654	WHISTLE PISTON & SEALS,1125PSI		1	\$	130.00
2006655	WHISTLE PISTON & SEALS,555 PSI		1	\$	130.00
2006658	PRESSURE GAUGE & SEAL,2216 PSI		1	\$	225.00
2006670	EXHALE VALVE C/W O-RING		1	\$	80.00
200673-01	ASSEMBLY,WIRELESS BOOT LOADER		1	\$	1,078.44
200674-01	GAUGE ASSY, AIR-PAK,2216 PSIG		1	\$	132.10
200674-02	GAUGE ASSY, AIR-PAK,4500 PSIG		1	\$	132.10
200674-03	GAUGE ASSY, AIR-PAK,3000 PSIG		1	\$	132.10
200674-04	GAUGE ASSY, NAVY,4500 PSIG		1	\$	132.10
200674-08	GAUGE ASSY, AIR-PAK,5500 PSIG		1	\$	130.00
200676-01	HOOD, FH22 (1 EA)		1	\$	49.40
200676-03	HOOD, FH22 (3 EA)		1	\$	140.80
200677-03	SHROUD, HOSE, PACK OF 3		1	\$	35.10
200681-01	QUICK CHARGE BOOT ASSY(FEMALE)		1	\$	40.60
200682-01	SE+ PAK-TRACKER UPGRADE KIT		1	\$	811.97
200684-01	'02 RIC BOOT ASSEMBLY		1	\$	40.00
200684-02	RIC BOOT ASSEMBLY		1	\$	40.00
200686-01	HOUSING ASSY (HANSEN)		1	\$	108.20
200687-01	HOUSING ASSY (SCHRADER)		1	\$	146.60
200688-D430	CYLINDER CAP, 4500-30 DOME		1	\$	29.10
200688-D445	CYLINDER CAP, 4500-45 DOME		1	\$	29.10
200688-S430	CYLINDER CAP, 4500-30 VALVE		1	\$	29.10
200688-S445	CYLINDER CAP, 4500-45 VALVE		1	\$	29.10
200689-01	KIT, CYLINDER CAP INSTALL		1	\$	53.00
200689-02	KIT, CYLINDER CAP INSTALL		1	\$	245.40
200698-00	KIT, C420 PLUS PAPR, LESS HOSE		1	\$	1,063.90
200698-30	KIT, C420 PLUS PAPR		1	\$	1,137.30
200698-36	KIT, C420 PLUS PAPR		1	\$	1,137.30
200699-01	BLOWER, C420 PLUS		1	\$	1,006.80
200700-30	BREATHING TUBE, C240 PAPR, 30"		1	\$	120.40
200700-36	BREATHING TUBE, C240 PAPR, 36"		1	\$	120.40
200701-01	CONV KIT, C420 NIMH BATTERY		1	\$	445.80
200703-01	BATTERY CHARGER, C420		1	\$	241.80
200708-01	BRACKET WELDMENT, LEFT		1	\$	9.93
200709-01	BRACKET WELDMENT, RIGHT		1	\$	9.50
200710-30	KIT, C420+ PAPR W/ LISO2 BATT		1	\$	1,234.20
200710-36	KIT, C420+ PAPR W/ LISO2 BATT		1	\$	1,234.20
200711-01	TOP ASSEMBLY, PT PROGRAMMER		1	\$	1,143.23
200715-01	EPIC BRACKET/AV3000,SERVICE KI		1	\$	31.35
200716-01	EPIC BRACKET/AV2000,SERVICE KI		1	\$	31.35
200718-02	ANTI-ROTN KIT, DUAL MANIFOLD		1	\$	33.30
200718-03	ANTI-ROTN KIT, SINGLE, RETRO	Service Item	1	\$	45.00
200718-04	ANTI-ROTN KIT, DUAL, RETRO	Service Item	1	\$	52.00
200718-05	ANTI-ROTN KIT, SINGLE, 02 HUD		1	\$	52.00
200718-06	ANTI-ROTN KIT, DUAL, 02 HUD		1	\$	52.00
200720-01	ASSEMBLY,NXG MANIFOLD CAP		1	\$	375.00
200721-01	ASSEMBLY,CLAMP,REGULATOR HOSE		1	\$	40.00
200721-02	ASSEMBLY,CLAMP,REGULATOR HOSE		1	\$	37.40
200721-03	ASSEMBLY,CLAMP,REGULATOR HOSE		1	\$	46.80
200725-01	PTT PADDLE, EPIC RI		1	\$	342.75
200728-01	KIT,AP75 TO POSI-CHECK		1	\$	162.20
200729-01	ASSY, SEMS II CONSOLE 4500 PSI		1	\$	2,061.00
200729-02	ASSY, SEMS II (2216 PSI)		1	\$	2,061.00
200729-03	ASSY, SEMS II CONSOLE 3000 PSI		1	\$	2,061.00

200729-04	ASSY, SEMS II CONSOLE 5500 PSI		1	\$	2,061.00
200734-01	RFID PROGRAMMER ASSEMBLY		1	\$	568.00
200739-01	NAVSEA EPIC AMP SERVICE KIT		1	\$	572.66
200740-01	INTERCONNECT BOARD ASSY		1	\$	61.00
200741-01	KIT, HOLE TEMPALTES, NXG		1	\$	117.50
200741-02	KIT, HOLE TEMPALTES, NXG		1	\$	117.50
200742-01	KIT, HOLE TEMPLATES, AP50		1	\$	117.50
200742-02	KIT, HOLE TEMPLATES, AP50		1	\$	117.50
200744-01	ASSY, EI 320,DEG F,W/O XMTR		1	\$	9,856.00
200744-11	ASSY, EI 320,DEG C,W/O XMTR		1	\$	10,538.00
200744-14	ASSY,EI320,DEGF,DVR W/O XMTR		1	\$	10,947.00
200744-18	ASSY,EI320,DEGC,DVR W/O XMTR		1	\$	10,790.00
200744-21	ASSY,EI320 LOC,DEGF W/O IMGCAP		1	\$	12,000.00
200744-22	ASSY,EI320 LOC,DEGF W/IMGCAP		1	\$	12,950.00
200744-31	ASSY,EI320 LOC,DEGC W/O IMGCAP		1	\$	12,000.00
200744-32	ASSY,EI320 LOC,DEGC W/IMGCAP		1	\$	12,950.00
200749-01	ASSY, LCD AND SHOCK MOUNT		1	\$	640.00
200756-01	GLARE SHIRLD ASSEMBLY		1	\$	313.00
200765-01	ASSY, MAIN HOUSING, SEMS II		1	\$	1,895.63
200766-01	AV-2000 CONVERSTION KIT		1	\$	56.10
200769-00	SPEAKER,EZ RADIOCOM II REP KIT		1	\$	96.14
200770-01	PT LABELS, BAG OF 10		1	\$	8.36
200772-01	SEMS II MESH GATEWAY KIT		1	\$	1,998.04
200773-01	RFID WRITER KIT		1	\$	605.88
200774-01	RFID TAG KIT		1	\$	113.00
200779-01	CYL&VLV ASSY, SKA-PAK AT		1	\$	760.00
200779-02	CYL & VALVE ASSY, SKA-PAK AT		1	\$	1,110.00
200779-03	CYL & VALVE ASSY, SKA-PAK		1	\$	720.00
200779-102	CYL&VLV,SP+&AT,15M4.5 SL		1	\$	1,260.00
200793-01	CORE ASSEMBLY, EAGLE 320		1	\$	8,971.00
200793-10	CORE ASSEMBLY, EAGLE 320 DEG C		1	\$	5,828.85
200795-01	ANTENNA PCB ASSY, EI 320		1	\$	32.63
200799-01	LENS ASSEMBLY		1	\$	437.00
200800-01	COVER, ASSY, REGULATOR		1	\$	110.00
200800-02	COVER, ASSY, REGULATOR		1	\$	110.00
200800-04	COVER, ASSY, REGULATOR		1	\$	110.00
200800-05	COVER, ASSY, REGULATOR		1	\$	110.00
200800-06	COVER, ASSY, REGULATOR		1	\$	110.00
200802-01	FACE SEAL,SMALL,SURESEAL		1	\$	164.30
200802-02	FACE SEAL,MED,SURESEAL		1	\$	164.30
200802-03	FACE SEAL,LARGE,SURESEAL		1	\$	164.30
200803-01	HEADNET ASM, SURESEAL		1	\$	170.40
200812-01	NXG7 BACKFRAME ASSEMBLY		1	\$	434.70
200816-02	EI 320 SERVICE KIT, DEG F XMTR		1	\$	6,889.00
200816-12	EI 320 SERVICE KIT, DEG C XMTR		1	\$	6,989.00
200817-01	PAK-TRACKER KIT ASSEMBLY		1	\$	3,149.63
200818-01	KIT,EZ FLO II COVER REPLACE		1	\$	170.00
200818-02	KIT,EZ FLO II COVER REPLACE		1	\$	170.00
200818-04	KIT,EZ FLO II COVER REPLACE		1	\$	170.00
200818-05	KIT,EZ FLO II COVER REPLACE		1	\$	170.00
200818-06	KIT,EZ FLO II COVER REPLACE		1	\$	170.00
200820-075	SUPPLY HOSE ASSY,'75 FT FOSTER		1	\$	400.00
200822-01	NAVY SKA-PAK AT ASSEMBLY		1	\$	5,450.00
200822-02	NAVY SKA-PAK AT ASSEMBLY		1	\$	5,450.00
200822-03	NAVY SKA-PAK AT ASSEMBLY		1	\$	5,450.00
200827-02	PROG CUST SERVICE KIT,2.2 PASS		1	\$	602.97
200827-03	PROG CUST SERVICE KIT,3.0 PASS		1	\$	602.97
200827-04	PROG CUST SERVICE KIT,4.5 PASS		1	\$	602.97
200827-05	PROG CONS SERV KIT,5.5 PASS		1	\$	602.97
200828-04	PROG CUST SERVICE KIT, HUD		1	\$	475.00
200829-30	AV-PAPR HOSE, 30"		1	\$	160.20

200829-36	AV-PAPR HOSE, 36"		1	\$ 165.30
200830-30	KIT, C420 & AV-PAPR HOSE, 30"		1	\$ 1,047.60
200830-36	KIT, C420 & AV-PAPR HOSE, 36"		1	\$ 1,047.60
200833-30	KIT, C420 PLUS PAPR W/BATTERY		1	\$ 1,234.20
200833-36	KIT, C420 PLUS PAPR W/BATTERY		1	\$ 1,234.20
200836-01	EI GLARE SHIELD KIT		1	\$ 10,506.00
200836-02	EI GLARE SHIELD KIT (TRANSMITT		1	\$ 11,303.00
200840-01	STRAP ASM, TOP CENTER, SURESEA		1	\$ 21.60
200841-01	SEMS II 4500 PSI FIELD INSTALL		1	\$ 930.15
200841-02	SEMS II 2216 PSI FIELD INSTALL		1	\$ 985.40
200841-03	SEMS II 3000 PSI FIELD INSTALL		1	\$ 930.15
200842-02	HSG, RIGHT COMPLETE, 2 BUTTON		1	\$ 250.00
200844-81	FIELD INSTALL KIT, SMALL SURES		1	\$ 195.90
200844-82	FIELD INSTALL KIT,MED SURESEAL		1	\$ 195.90
200844-83	FIELD INSTALL KIT,LARGE SURESE		1	\$ 195.90
200847-01	LCD ASSEMBLY, TAC TIC		1	\$ 414.00
200848-01	BATTERY, TAC TIC		1	\$ 215.00
200850-01	BULKHEAD PLATE ASSEMBLY		1	\$ 49.00
200858-101	WAIST PAD/BELT ASSY-S		1	\$ 780.00
200858-111	WAIST PAD/BELT ASSY-M		1	\$ 780.00
200858-121	WAIST PAD/BELT ASSY-L		1	\$ 780.00
200859-32	WAIST BELT ASSY-M,AP,R,MU		1	\$ 730.00
200859-E	EXTENSION, WAIST BELT		1	\$ 85.00
200860-201	BAILOUT SYSTEM ASSY-50,F4,CR		1	\$ 1,040.00
200860-202	BAILOUT SYSTEM ASSY-75,F4,CR		1	\$ 1,210.00
200860-212	BAILOUT SYSTEM ASSY-75,F4,CA		1	\$ 1,130.00
200861-101	EZ-SI, O, 50, CR, FAL		1	\$ 1,190.00
200861-102	EZ-SI, O, 75, CR, FAL		1	\$ 1,280.00
200861-111	EZ-SI, O, 50, CA, FAL		1	\$ 1,130.00
200861-201	EZ-SI, WF, O, 50, CR, FAL		1	\$ 1,190.00
200861-202	EZ-SI, WF, O, 75, CR, FAL		1	\$ 1,280.00
200861-211	EZ-SI, WF, O, 75, CA, FAL		1	\$ 960.00
200864-01	PROG ASSY,MAIN HSG,4.5 SEMS II		1	\$ 1,002.30
200864-02	PROG ASSY,MAIN HSG,2.2 SEMS II		1	\$ 1,002.30
200864-03	PROG ASSY,MAIN HSG,3.0 SEMS II		1	\$ 1,001.65
200866-01	ASSY,BACKFRAME HDWRE, NXG2		1	\$ 434.70
200867-01	LP QD REDUCER HOSE ASSY, ACS		1	\$ 160.00
200868-01	POSICHEK3 TEST HOSE ASSY, ACS		1	\$ 90.00
200870-01	CYL&VLV ASSY CARB,30MIN,4500		1	\$ 1,000.00
200870-01-D	CYL&VALV ASSY CARB,30MIN,4500		1	\$ 1,000.00
200871-01	CYL&VLV ASSY CARB,45MIN,4500		1	\$ 1,370.00
200871-01-D	CYL&VALV ASSY CARB,45MIN,4500		1	\$ 1,370.00
2008713	REGULATOR, FIRST STAGE 2216PSI		1	\$ 500.00
200872-01	CYL&VLV ASSY CARB,60MIN,4500		1	\$ 1,530.00
200872-01-D	CYL&VALV ASSY CARB,60MIN,4500		1	\$ 1,530.00
200873-01	CYL&VLV ASSY CARB,30MIN,2216		1	\$ 1,120.00
200873-01-D	CYL&VALV ASSY CARB,30MIN,2216		1	\$ 1,120.00
200874-01	CYL&VLV ASSY AL,30MIN,2216		1	\$ 630.00
200874-01-D	CYL&VALV ASSY AL,30MIN,2216		1	\$ 630.00
200877-01	BACK FRAME, ACSi		1	\$ 380.00
200879-01	HAN/FOSTER, ACS EXT DURATION		1	\$ 425.00
200879-02	SCHRADER, ACS EXT DURATION		1	\$ 425.00
200879-03	HAN HK PLUG, ACS EXT DURATION		1	\$ 425.00
200879-04	HAN HK SCKT, ACS EXT DURATION		1	\$ 425.00
200879-05	CEJN, ACS EXT DURATION		1	\$ 425.00
200882-01	HOSE ASSY, ACS EXT DURATION		1	\$ 245.00
200888-01	ASSEMBLY, 4500 PSI ACS VALVE		1	\$ 430.00
200889-01	ASSEMBLY, 2216 PSI ACS VALVE		1	\$ 425.00
200893-01	LICENSE KIT,PAK-TRACKER SOFTWR		1	\$ 382.47
200895-01	POUCH, SHOULDER STRAP, EBSS		1	\$ 120.00
200896-01	2007 SERVICE PROGRAMMER		1	\$ 716.87

200898-01	SPARE, BOOT, AV-PAPR HOSE		1	\$	41.90
200899-01	WAIST PAD ASSY,AP7 & NxG7,FI		1	\$	565.00
200900-01	WAIST PAD ASSY,WIREFRAME,FI		1	\$	554.30
200904-01	ROPE WEAVING FIXTURE ASY,50,FI		1	\$	40.00
200904-02	ROPE WEAVING FIXTURE ASY,75,FI		1	\$	40.00
200906-01	WAIST PAD ASSY,AP75&NxG7,RIT		1	\$	510.00
200909-01	WEBBING ASSY,50,CR,RIT		1	\$	430.00
200910-01	VALVE, KUNKLE RELIEF KIT 4.5	Service Item	1	\$	176.80
200910-02	VALVE, KUNKLE RELIEF KIT 2.2	Service Item	1	\$	176.80
200910-03	KIT,VLV,KUNKLE RLF 4.5, UPGR07	Service Item	1	\$	187.20
200910-04	KIT,VLV,KUNKLE RLF 2.2, UPGR07	Service Item	1	\$	187.20
200915-01	FILTER COVER, XCEL HS 2 PC		1	\$	8.10
200915-70	FILTER COVER, XCEL HS 70 PAIRS		1	\$	528.40
2009164	ASSEMBLY, ELSA 5MIN ESC DEVICE		1	\$	495.00
2009165	ASSEMBLY, ELSA 10MIN ESC DEVCE		1	\$	610.00
200917-01	EI320 DEGF,GLARE SHIELD & CASE		1	\$	11,312.00
200917-02	EI 320 F /GLARE SHLD,XMTR&CASE		1	\$	12,131.00
200918-111	EZ-S II, S, 50, CR, F4 TS		1	\$	1,560.00
200918-112	EZ-S II, S, 75, CR, F4 TS		1	\$	1,640.00
200918-115	EZ-S II, S,50,CA,F4,TS		1	\$	1,480.00
200918-116	EZ-S II, S,75,CA,F4,TS		1	\$	1,610.00
200918-121	EZ-S II, M, 50, CR, F4 TS		1	\$	1,560.00
200918-122	EZ-S II, M, 75, CR, F4 TS		1	\$	1,640.00
200918-125	EZ-S II, M,50,CA,F4,TS		1	\$	1,480.00
200918-126	EZ-S II, M,75,CA,F4,TS		1	\$	1,620.00
200918-131	EZ-S II, L, 50, CR, F4 TS		1	\$	1,560.00
200918-132	EZ-S II, L, 75, CR, F4 TS		1	\$	1,640.00
200918-135	EZ-S II, L,50,CA,F4,TS		1	\$	1,500.00
200918-136	EZ-S II, L,75,CA,F4,TS		1	\$	1,620.00
200918-141	EZ-S III, S, 50, CR, AP, F4 TS		1	\$	1,620.00
200918-142	EZ-S III, S, 75, CR, AP, F4 TS		1	\$	1,700.00
200918-145	EZ-S III, S,50,CA,AP,R,F4,TS		1	\$	1,540.00
200918-146	EZ-S III, S,75,CA,AP,R,F4,TS		1	\$	1,680.00
200918-151	EZ-S III, M, 50, CR, AP, F4 TS		1	\$	1,620.00
200918-152	EZ-S III, M, 75, CR, AP, F4 TS		1	\$	1,700.00
200918-155	EZ-S III, M,50,CA,AP,R,F4,TS		1	\$	1,550.00
200918-156	EZ-S III, M,75,CA,AP,R,F4,TS		1	\$	1,680.00
200918-161	EZ-S III, L, 50, CR, AP, F4 TS		1	\$	1,620.00
200918-162	EZ-S III, L, 75, CR, AP, F4 TS		1	\$	1,700.00
200918-165	EZ-S III, L,50,CA,AP,R,F4,TS		1	\$	1,550.00
200918-166	EZ-S III, L,75,CA,AP,R,F4,TS		1	\$	1,690.00
200918-171	EZ-S IV, S, 50, CR,AP,F4,MU,TS		1	\$	1,910.00
200918-172	EZ-S IV, S, 75, CR,AP,F4,MU,TS		1	\$	1,990.00
200918-175	EZ-S IV, S,50,CA,AP,R,F4,MU,TS		1	\$	1,860.00
200918-176	EZ-S IV, S,75,CA,AP,R,F4,MU,TS		1	\$	1,980.00
200918-181	EZ-S IV, M, 50, CR,AP,F4,MU,TS		1	\$	1,910.00
200918-182	EZ-S IV, M, 75, CR,AP,F4,MU,TS		1	\$	1,990.00
200918-185	EZ-S IV, M,50,CA,AP,R,F4,MU,TS		1	\$	1,860.00
200918-186	EZ-S IV, M,75,CA,AP,R,F4,MU,TS		1	\$	1,990.00
200918-191	EZ-S IV, L, 50, CR,AP,F4,MU,TS		1	\$	1,910.00
200918-192	EZ-S IV, L, 75, CR,AP,F4,MU,TS		1	\$	1,990.00
200918-195	EZ-S IV, L,50,CA,AP,R,F4,MU,TS		1	\$	1,870.00
200918-196	EZ-S IV, L,75,CA,AP,R,F4,MU,TS		1	\$	1,990.00
200918-211	EZ-S II, WF, S, 50, CR, F4, TS		1	\$	1,560.00
200918-212	EZ-S II, WF, S, 75, CR, F4, TS		1	\$	1,640.00
200918-213	EZ-S II,WF,S,50,CR,8P,TS		1	\$	1,450.00
200918-214	EZ-S II,WF,S,75,CR,8P,TS		1	\$	1,520.00
200918-215	EZ-S II,WF,S,50,CA,F4,TS		1	\$	1,480.00
200918-216	EZ-S II,WF,S,75,CA,F4,TS		1	\$	1,610.00
200918-221	EZ-S II, WF, M, 50, CR, F4, TS		1	\$	1,560.00
200918-222	EZ-S II, WF, M, 75, CR, F4, TS		1	\$	1,640.00



200918-225	EZ-S II,WF,M,50,CA,F4,TS		1	\$	1,480.00
200918-226	EZ-S II,WF,M,75,CA,F4,TS		1	\$	1,620.00
200918-231	EZ-S II,WF,L,50,CR,F4,TS		1	\$	1,560.00
200918-232	EZ-S II,WF,L,75,CR,F4,TS		1	\$	1,640.00
200918-235	EZ-S II,WF,L,50,CA,F4,TS		1	\$	1,500.00
200918-236	EZ-S II,WF,L,75,CA,F4,TS		1	\$	1,620.00
200918-241	EZ-S III,WF,S,50,CR,AP,R,F4,TS		1	\$	1,620.00
200918-242	EZ-S III,WF,S,75,CR,AP,R,F4,TS		1	\$	1,700.00
200918-245	EZ-S III,WF,S,50,CA,AP,R,F4,TS		1	\$	1,540.00
200918-246	EZ-S III,WF,S,75,CA,AP,R,F4,TS		1	\$	1,680.00
200918-251	EZ-S III,WF,M,50,CR,AP,R,F4,TS		1	\$	1,620.00
200918-252	EZ-S III,WF,M,75,CR,AP,R,F4,TS		1	\$	1,700.00
200918-255	EZ-S III,WF,M,50,CA,AP,R,F4,TS		1	\$	1,550.00
200918-256	EZ-S III,WF,M,75,CA,AP,R,F4,TS		1	\$	1,680.00
200918-261	EZ-S III,WF,L,50,CR,AP,R,F4,TS		1	\$	1,620.00
200918-262	EZ-S III,WF,L,75,CR,AP,R,F4,TS		1	\$	1,700.00
200918-265	EZ-S III,WF,L,50,CA,AP,R,F4,TS		1	\$	1,550.00
200918-266	EZ-S III,WF,L,75,CA,AP,R,F4,TS		1	\$	1,690.00
200918-271	EZ-S IV,WF,S,50,CR,AP,R,F4,MU		1	\$	1,910.00
200918-272	EZ-S IV,WF,S,75,CR,AP,R,F4,MU		1	\$	1,990.00
200918-275	EZ-S IV,WF,S,50,CA,AP,R,F4MUTS		1	\$	1,860.00
200918-276	EZ-S IV,WF,S,75,CA,AP,R,F4MUTS		1	\$	1,980.00
200918-281	EZ-S IV,WF,M,50,CR,AP,R,F4,MU		1	\$	1,910.00
200918-282	EZ-S IV,WF,M,75,CR,AP,R,F4,MU		1	\$	1,990.00
200918-285	EZ-S IV,WF,M,50,CA,AP,R,F4MUTS		1	\$	1,860.00
200918-286	EZ-S IV,WF,M,75,CA,AP,R,F4MUTS		1	\$	1,990.00
200918-291	EZ-S IV,WF,L,50,CR,AP,R,F4,MU		1	\$	1,910.00
200918-292	EZ-S IV,WF,L,75,CR,AP,R,F4,MU		1	\$	1,990.00
200918-295	EZ-S IV,WF,L,50,CA,AP,R,F4MUTS		1	\$	1,870.00
200918-296	EZ-S IV,WF,L,75,CA,AP,R,F4MUTS		1	\$	1,990.00
200920-01	HOSE,HIGH PRESSURE		1	\$	250.00
200921-01	E320 VIDEO CAPTURE BOARD ASSY		1	\$	435.71
200922-01	HOSE&COUPLING, HIGH PRESSURE		1	\$	375.00
200922-02	HOSE&COUPLING, HIGH PRESSURE		1	\$	375.00
200923-009	PACKING, PREFORMED		1	\$	4.50
200924-01	INLET ASSY (2.2)		1	\$	477.00
200924-02	INLET ASSY (4.5)		1	\$	477.00
200924-03	INLET ASSY (5.5)		1	\$	477.00
200925-01	CGA PRESSURE REDUCER,AP75 2.2		1	\$	1,200.00
200925-02	CGA PRESSURE REDUCER,AP75 4.5		1	\$	1,200.00
200925-03	CGA PRESSURE REDUCER,AP75		1	\$	1,250.00
200925-04	CGA PRES REDUCER,AP75(2.2,33%)		1	\$	1,250.00
200925-05	CGA PRES REDUCER,AP75(4.5,33%)		1	\$	1,250.00
200925-06	CGA PRES REDUCER,AP75(5.5,33%)		1	\$	1,250.00
200926-01	NxG PRESSURE REDUCER		1	\$	1,940.00
200926-02	NxG PRESSURE REDUCER		1	\$	1,940.00
200926-03	NxG PRESSURE REDUCER		1	\$	1,940.00
200927-01	INLET/LATCH ASSEMBLY		1	\$	500.00
200927-02	INLET/LATCH ASSEMBLY		1	\$	500.00
200927-03	INLET/LATCH ASSEMBLY		1	\$	500.00
200928-02	GAUGE, DUAL POINTER, 5500 PSI		1	\$	130.00
200930-01	CYL&VALV,CGA,CARB,30/5500 ASSY		1	\$	1,110.00
200930-01-1	CYL&VALV,CGA,CARB,30/5500 ASSY		1	\$	1,110.00
200930-01-1D	CYL&VALV,CGA,CARB,30/5500 ASSY		1	\$	1,110.00
200930-01-D	CYL&VALV,CGA,CARB,30/5500 ASSY		1	\$	1,110.00
200931-01	TALK-AROUND SPACER KIT		1	\$	11.00
200932	USB VIDEO DOWNLOAD CABLE		1	\$	94.00
200950-01	EI 302 DVR UPGRADE KIT		1	\$	1,496.00
200951-01	M8 PIGTAIL REPL KIT **SVC ITEM	Service Item	1	\$	57.30
200951-02	M8 PIGTAIL REPL KIT **SVC ITEM	Service Item	1	\$	54.00
200951-03	M8 PIGTAIL REPL KIT **SVC ITEM	Service Item	1	\$	50.00

200952-01	KIT, CYLINDER SLEEVE		1	\$	102.00
200952-02	KIT, CYLINDER SLEEVE 30M 4500		1	\$	113.40
200952-03	KIT, CYLINDER SLEEVE 45M 4500		1	\$	113.40
200952-04	KIT, CYLINDER SLEEVE 60M 4500		1	\$	113.40
200952-05	KIT, FIELD, CYL SLEEVE 15M 450		1	\$	97.00
200953-01	EI 302 MTG RAIL KIT		1	\$	8.35
200953-02	EI 320 MTG RAIL KIT W/FLASHLGT		1	\$	229.90
200954-01	RIT-PAK III ASSY, 2216 PSI		1	\$	3,190.00
200954-02	RIT-PAK III ASSY, 4500 PSI		1	\$	3,190.00
200954-03	RIT-PAK III ASSY, 2.2, W/O M&R		1	\$	2,740.00
200954-04	RIT-PAK III ASSY, 4.5, W/O M&R		1	\$	2,740.00
200954-05	RIT-PAK III ASSY, 5500 PSI		1	\$	3,290.00
200954-06	RIT-PAK III ASSY, 5.5, W/O M&R		1	\$	2,850.00
200955-01	BAG ASSEMBLY, RIT-PAK		1	\$	776.30
200957-01	PNEUMATIC ASSY, RIT-PAK, 2216		1	\$	2,700.00
200957-02	PNEUMATIC ASSY, RIT-PAK, 4500		1	\$	2,700.00
200957-05	PNEUMATIC ASSY, RIT-PAK, 5500		1	\$	2,810.00
200958-01	HOSE & MANIFOLD ASSY - RIT-PAK		1	\$	513.80
200959-01	AV3000 MASK ASSEMBLY, RIT-PAK		1	\$	222.50
200960-01	CHARGING WAND ASSY, RIT-PAK		1	\$	836.20
200961-01	ASSY, RIT-PAK CONSOLE		1	\$	1,220.00
200961-02	ASSY, RIT-PAK CONSOLE		1	\$	1,220.00
200962-01	REGULATOR ASSEMBLY, RIT-PAK		1	\$	673.90
200965-01	HEADNET ASSY, POLY, SURESEAL		1	\$	78.60
200967-01	CYL&VALV, QD, CARB, 30/5500 ASSY		1	\$	1,110.00
200967-01-1	CYL&VALV, QD, CARB, 30/5500 ASSY		1	\$	1,110.00
200967-01-1D	CYL&VALV, QD, CARB, 30/5500 ASSY		1	\$	1,110.00
200967-01-D	CYL&VALV, QD, CARB, 30/5500 ASSY		1	\$	1,110.00
200969-01	CYL&VALV, CGA, CARB, 45/5500 ASSY		1	\$	1,500.00
200969-01-1	CYL&VALV, CGA, CARB, 45/5500 ASSY		1	\$	1,500.00
200969-01-1D	CYL&VALV, CGA, CARB, 45/5500 ASSY		1	\$	1,500.00
200969-01-D	CYL&VALV, CGA, CARB, 45/5500 ASSY		1	\$	1,500.00
200970-01	CYL&VALV, QD, CARB, 45/5500 ASSY		1	\$	1,500.00
200970-01-1	CYL&VALV, QD, CARB, 45/5500 ASSY		1	\$	1,500.00
200970-01-1D	CYL&VALV, QD, CARB, 45/5500 ASSY		1	\$	1,500.00
200970-01-D	CYL&VALV, QD, CARB, 45/5500 ASSY		1	\$	1,500.00
200972-01	CYL&VALV, CGA, CARB, 60/5500 ASSY		1	\$	1,680.00
200972-01-1	CYL&VALV, CGA, CARB, 60/5500 ASSY		1	\$	1,680.00
200972-01-1D	CYL&VALV, CGA, CARB, 60/5500 ASSY		1	\$	1,680.00
200972-01-D	CYL&VALV, CGA, CARB, 60/5500 ASSY		1	\$	1,680.00
200973-01	CYL&VALV, QD, CARB, 60/5500 ASSY		1	\$	1,680.00
200973-01-1	CYL&VALV, QD, CARB, 60/5500 ASSY		1	\$	1,680.00
200973-01-1D	CYL&VALV, QD, CARB, 60/5500 ASSY		1	\$	1,680.00
200973-01-D	CYL&VALV, QD, CARB, 60/5500 ASSY		1	\$	1,680.00
200975-01	CYL&VALV, CGA, CARB, 75/5500 ASSY		1	\$	1,860.00
200975-01-1	CYL&VALV, CGA, CARB, 75/5500 ASSY		1	\$	1,860.00
200975-01-1D	CYL&VALV, CGA, CARB, 75/5500 ASSY		1	\$	1,860.00
200975-01-D	CYL&VALV, CGA, CARB, 75/5500 ASSY		1	\$	1,860.00
200976-01	CYL&VALV, QD, CARB, 75/5500 ASSY		1	\$	1,860.00
200976-01-1	CYL&VALV, QD, CARB, 75/5500 ASSY		1	\$	1,860.00
200976-01-1D	CYL&VALV, QD, CARB, 75/5500 ASSY		1	\$	1,860.00
200976-01-D	CYL&VALV, QD, CARB, 75/5500 ASSY		1	\$	1,860.00
200977-01	BATTERY CHARGER, EAGLE ATTACK		1	\$	861.00
200978-01	DVR POWER BOARD		1	\$	424.00
200979-01	DVR PROCESSOR BOARD		1	\$	654.00
200980-01	TAC-TIC POWER BOARD		1	\$	129.00
200984-01	TRANSFER VALVE ASSEMBLY	Service Item	1	\$	40.00
200984-02	TRANSFER VALVE ASSEMBLY	Service Item	1	\$	40.00
200984-03	TRANSFER VALVE ASSEMBLY	Service Item	1	\$	40.00
200989-01	SHOULDER STRAP ASSY, RIT-PAK		1	\$	125.00
200991-01	CARRYING STRAP KIT, RIT-PAK III		1	\$	125.00

201001-01	CHARGER INTERFACE ASSY.		1	\$	81.13
201002-01	POWER SWITCH ASSEMBLY		1	\$	85.00
201008-01	BATTERY RETAINER STRAP		1	\$	35.00
201009-01	L3 3600 CORE ASSY, NON-COLOR, F		1	\$	4,736.00
201009-02	L3 3600 CORE ASSY, COLOR, F		1	\$	5,275.00
201009-10	L3 3600 CORE ASSY, NON-COLOR, C		1	\$	4,736.00
201009-12	L3 3600 CORE ASSY, COLOR, C		1	\$	5,275.00
2010173	ANTI-FOG WIPE, 1 PACK		1	\$	9.40
201018-01	LABEL, E-Z FLO REG, W/VIBRALERT		1	\$	4.20
201018-02	LABEL, E-Z FLO REG, MODULAIR		1	\$	4.20
201018-03	LABEL, E-Z FLO+ REG, W/VIBRALERT		1	\$	4.20
201018-04	LABEL, E-Z FLO REGULATOR		1	\$	4.20
201018-05	LABEL, E-Z FLO REGULATOR, SWAT		1	\$	4.20
201018-06	LABEL, E-Z FLO+ REG, W/VIB, SWAT		1	\$	4.20
201021-01	RERTRACTABLE LANYARD		1	\$	48.00
201023-01	LABEL, COVER, REGULATOR, CBRN		1	\$	4.40
201023-02	LABEL, COVER, REGULATOR, SCOTT		1	\$	4.40
201023-03	LABEL, COVER, REG, W/WARNING		1	\$	4.40
201026-01	SPARE BATTERY, TACTICAL TIC		1	\$	222.00
201026-02	SPARE BATTERY, TACTICAL TIC		1	\$	230.00
201026-03	SPARE BATTERY, TACTICAL TIC		1	\$	230.00
201026-04	SPARE BATTERY, TACTICAL TIC		1	\$	222.00
201027-01	MANIFOLD ASSY, LOW PRESSURE		1	\$	468.00
201028-01	HOUSING, SUB ASSEMBLY		1	\$	292.20
201029-01	KIT, X3 TO POSI-CHEK		1	\$	230.00
201030-01	PRESSURE REDUCER, X3 (2.2, CGA)		1	\$	1,867.00
201030-02	PRESSURE REDUCER, X3 (4.5, CGA)		1	\$	1,867.00
201030-03	PRESSURE REDUCER, X3 (5.5, CGA)		1	\$	1,867.00
201030-04	PRESSURE REDUCER, X3 (2.2, QD)		1	\$	1,867.00
201030-05	PRESSURE REDUCER, X3 (4.5, QD)		1	\$	1,867.00
201030-06	PRESSURE REDUCER, X3 (5.5, QD)		1	\$	1,867.00
201040-01	EAGLE ATTACK PRESSURE TEST ASY		1	\$	133.00
201043-01	BRACKET ASSY, QD		1	\$	50.00
201044-01	BRACKET ASSY, CGA		1	\$	50.00
201045-01	TRANSFER VALVE ASSY, 35% (2.2)		1	\$	38.25
201045-02	TRANSFER VALVE ASSY, 35% (3.5)		1	\$	38.25
201045-03	TRANSFER VALVE ASSY, 35% (5.5)		1	\$	38.25
201051-01	REPEATER ASSY		1	\$	1,729.48
201056-01	GAUGE BLOCK/FILTER ASSY		1	\$	45.00
201079-01	ASSY, BATTERY DOOR, EPIC 3		1	\$	40.40
201081-01	ASSY, THUMB LATCH, EPIC 3		1	\$	30.30
201083-01	CYLINDER RETENTION, OVERMOLDED		1	\$	12.00
2010880	SPARE HOOD FOR SCOTT ELSA		1	\$	110.00
201088-01	SEMS II, USB GATEWAY		1	\$	1,891.13
201088-02	SEMS II, USB GATEWAY		1	\$	1,891.13
2010881	SPARE REDUCER FOR ELSA 5, 15		1	\$	370.00
2010882	SPARE REDUCER FOR ELSA 10		1	\$	370.00
2010884	SPARE BAG FOR SCOTT ELSA 5		1	\$	83.00
2010885	SPARE BAG FOR SCOTT ELSA 10		1	\$	83.00
201089-01	BACK FRAME WELDMENT ASSY, X3		1	\$	418.00
201090-02	SEMS FASTENER, #10-32 x 1/2"		1	\$	2.58
201090-03	SEMS FASTENER, #10-32 x 1"		1	\$	2.58
201100-01	AIR-PAK X3 BACK-PAK ASSY, PARA		1	\$	1,239.00
201100-02	AIR-PAK X3 BACK-PAK ASY, SPRING		1	\$	1,239.00
201100-11	AIR-PAK X3 BK-PK ASY, FFSR, PARA		1	\$	850.00
201100-12	AIR-PAK X3 BK-PK ASY, FFSR, SPRG		1	\$	850.00
201109-01	MANIFOLD, PLUGGED		1	\$	350.00
201110-01	X3, CONSOLE ASSY, PASS, 4500, 1/4		1	\$	1,119.00
201110-02	X3, CONSOLE ASSY, PASS, 2216, 1/4		1	\$	1,119.00
201110-03	X3, CONSOLE ASSY, PASS, 5500, 1/4		1	\$	1,119.00
201111-01	X3, ELECTRONICS ASSY, PASS		1	\$	620.00

201112-11	X3, CONSOLE GAUGE, 4500, 1/3		1	\$	145.00
201112-12	X3, CONSOLE GAUGE, 2216, 1/3		1	\$	145.00
201112-13	X3, CONSOLE GAUGE, 5500, 1/3		1	\$	145.00
201119-01	X3, GUAGE LINE ASSY		1	\$	190.00
201123-01	X3, ELECTRONICS ASSY, SEMS		1	\$	620.00
201126-02	NOSECUP, AV3, S ASY, RED VALVES		1	\$	49.00
201127-02	NOSECUP, AV3, M ASY, RED VALVES		1	\$	49.00
201128-02	NOSECUP, AV3, L ASY, RED VALVES		1	\$	49.00
201134-01	FEN., DRILLED, COATED, AV3 HT		1	\$	145.00
201136-01	HOSE ASSY, QD, HUD, X3, CGA		1	\$	485.00
201136-02	HOSE ASSY, QD, HUD, X3, SNAP FIT		1	\$	485.00
201137-01	WAIST PAD ASSY, X3, PARA		1	\$	401.00
201137-02	WAIST PAD ASSY, X3, SPRING		1	\$	401.00
201138-01	HOSE ASSY, HUD, X3, CGA		1	\$	500.00
201138-02	HOSE ASSY, HUD, X3, SNAP FIT		1	\$	500.00
201139-01	SHOULDER STRAP ASSY, X3 PARA		1	\$	599.00
201139-02	SHOULDER STRAP ASSY, X3, SPRING		1	\$	599.00
201146-01	ACCESSORY HOSE, POSI-CHEK 3, QD		1	\$	78.00
201149-01	CABLE ASSY, TRANSDUCER		1	\$	125.00
201160-01	ASSY, SEN MOD, X3		1	\$	1,934.00
201160-02	ASSY, SEN MOD W/PAKTRKR, X3		1	\$	1,934.00
201161-01	ASSY, SENSOR MODULE HOUSING, X3		1	\$	990.00
201163-01	ASSY, BATT CAP, SEN MODULE, X3		1	\$	24.00
201180-01	ASSY, CYLINDER RETENTION		1	\$	135.00
201181-01	ASSY, HANDLE, CYLINDER RETENTION		1	\$	35.00
201182-01	ASSY, STRAP, CYLINDER RETENTION		1	\$	62.00
201198-01	SOF-PAK		1	\$	4,760.00
201208-01	UK TEMPEST TO US AIRPAK		1	\$	309.00
201210-01	ASSY, COM BRKT, AV3 HT, SER KIT, R		1	\$	30.30
201210-02	ASSY, COM BRKT, AV3 HT, SER KIT, L		1	\$	75.75
201214-01	QUEUE INTERFACE KIT		1	\$	2,500.00
201215-01	AV-3000 HT (S), KVLR		1	\$	350.00
201215-02	AV-3000 HT (M), KVLR		1	\$	350.00
201215-03	AV-3000 HT (L), KVLR		1	\$	350.00
201215-04	AV-3000 HT (S), KVLR w/ R BRKT		1	\$	376.00
201215-05	AV-3000 HT (M), KVLR w/ R BRKT		1	\$	376.00
201215-06	AV-3000 HT (L), KVLR w/ R BRKT		1	\$	376.00
201215-07	AV-3000 HT (S), KVLR w/ L BRKT		1	\$	430.00
201215-08	AV-3000 HT (M), KVLR w/ L BRKT		1	\$	430.00
201215-09	AV-3000 HT (L), KVLR w/ L BRKT		1	\$	430.00
201275-01	PACKAGING, EPIC 3 AMP, SINGLE		1	\$	495.00
201275-0125	PACKAGING, EPIC 3 AMP, BULK		1	\$	11,665.50
201279-01	SEMS II, TALLY TAG, 10 PACK, RED		1	\$	95.00
201279-02	SEMS II, TALLY TAG, 10 PACK, WHT		1	\$	95.00
201279-03	SEMS II, TALLY TAG, 10 PACK, BLK		1	\$	95.00
201279-04	SEMS II, TALLY TAG, 10 PACK, YEL		1	\$	95.00
201279-05	SEMS II, TALLY TAG, 10 PACK, ORG		1	\$	95.00
201279-06	SEMS II, TALLY TAG, 10 PACK, GRN		1	\$	95.00
201279-07	SEMS II, TALLY TAG, 10 PACK, BLU		1	\$	95.00
201279-08	SEMS II, TALLY TAG, 10 PACK, PNK		1	\$	95.00
201280-01	SEMS II, BUTTON TAG, 10 PACK		1	\$	95.00
201284-01	BRACKET, PIVOT ASSY		1	\$	20.00
201311-01	SERV KIT, HT VM DUCT ASSY, RT		1	\$	29.00
201311-02	SERV KIT, HT VM DUCT ASSY, LT		1	\$	29.00
201325-01	KIT, NXG2 ELEC CABLE		1	\$	225.00
201334-01	SCOTT POSI3 USB UPGRADE ASSEMB		1	\$	1,500.00
201335-01	SCOTT POSI3 USB CALIBRATION KI		1	\$	11,170.00
201336-01	KIT, SCOTT POSI3 USB 5500 ASSY		1	\$	9,300.00
201337-01	ASSY UNIT POSI3 USB 5500 SCOTT		1	\$	7,440.00
2014226	ASSEMBLY, ELSA-15		1	\$	670.00
2015330	SPARE BAG, ELSA 15		1	\$	83.00

2015879	HOSE, HP, GAUGE, ACS		1	\$	245.00
2016236	WASHER, 5 PACK		1	\$	9.40
2017070	RESP FIT TEST KIT (BITREX) REF		1	\$	246.90
2017092	APPLICATOR KIT, SENSITIVITY		1	\$	23.50
2017093	APPLICATOR KIT, FIT TEST		1	\$	23.50
2017094	NEBULIZER, BITREX, LABELS		1	\$	85.70
2017095	HOOD, FIT TEST, BITREX		1	\$	34.70
2017491	LOCK NUT, 5 PACK		1	\$	9.70
2018340	BODY, REDUCER, ACS		1	\$	285.00
2018341	O-RING, VITON, AS568-006		1	\$	1.20
2018839	SINGLE CYLINDER BAND, ACSi		1	\$	35.00
2019228	PROBE, 2216 PSI REDUCER, ACS		1	\$	285.00
2019229	PROBE, 4500 PSI, ACS		1	\$	285.00
2019231	REDUCER, ACS, 2216 PSI		1	\$	500.00
2019232	REDUCER, ACS, 4500 PSI		1	\$	590.00
2019374	PLUG, BLANK, HP, ACS		1	\$	44.00
2020313	WHISTLE AND GAUGE, 2216, ACS		1	\$	425.00
2020314	WHISTLE AND GAUGE, 4500, ACS		1	\$	425.00
2021489	COVER, ACS		1	\$	44.00
2021535	SCREW, ACS		1	\$	9.00
21917-02	STRIKER ASSY, PAK-ALARM**	Service Item	1	\$	31.20
26026-01	BAND,RUBBER		1	\$	2.80
26037-01	HOSE SUB-ASSY		1	\$	197.60
26042-01	FASTENER ASSY		1	\$	31.20
26369-006	6'SUPPLY HOSE,HANSEN HK		1	\$	230.00
26369-010	10'SUPPLY HOSE,HANSEN HK		1	\$	230.00
26369-025	25'SUPPLY HOSE,HANSEN HK		1	\$	350.00
26369-050	50'SUPPLY HOSE,HANSEN HK		1	\$	420.00
26369-100	100'SUPPLY HOSE,HANSEN HK		1	\$	540.00
26370-006	6' SUPPLY HOSE,S/S FOSTER		1	\$	120.00
26370-010	SUPPLY HOSE FOSTER		1	\$	140.00
26370-025	25' SUPPLY HOSE,S/S FOSTER		1	\$	190.00
26370-050	50' SUPPLY HOSE,S/S FOSTER		1	\$	270.00
26370-100	100' SUPPLY HOSE,S/S FOSTER		1	\$	420.00
26370-150	150' SUPPLY HOSE, S/S FOSTER		1	\$	570.00
26390-13	MANIFOLD ASSY		1	\$	488.80
26896-01	BUCKLE ASSY, SPARE PARTS		1	\$	67.40
26954-00	2.2 CYLVLV SAFETY DEV RPL KIT		1	\$	29.10
26954-01	4.5 CYLVLV SAFETY DEV RPL KIT		1	\$	29.10
26954-02	3.0 SAFETY DEVICE KIT		1	\$	29.10
26954-03	5.5 SAFETY DEVICE KIT		1	\$	29.10
26977-01	KIT,HARDWARE, FRAME		1	\$	16.40
26978-01	KIT,TOOL,FRAME RETAINER		1	\$	10.70
26985-01	AP 50 HARNESS RPL KIT, BLK KEV		1	\$	894.40
26985-04	ISCBA HARNESS RPL KIT, BLK KEV		1	\$	417.00
26985-05	AP HARNESS RPL KIT, BLK KEV		1	\$	417.00
26985-08	AP HARNESS RPL KIT SNAPS,BLK K		1	\$	449.30
26986-01	CYLINDER RETENTION KIT(WFORM)		1	\$	135.00
27245-01	PACKING, PREFORMED SQUARE		1	\$	3.20
27436-01	HANGER, CYLINDER		1	\$	55.00
27436-02	HANGER, CYLINDER		1	\$	18.20
27501-01	HEX DRIVER (3/32 INCH)	Service Item	1	\$	45.80
27501-02	HEX DRIVER (7/64 INCH)		1	\$	35.40
27501-03	HEX DRIVER (3/16 INCH)	Service Item	1	\$	49.90
27537-01	ACCESSORY HOSE ASSY,HANSEN		1	\$	320.00
27537-02	ISCBA AIRLINE HOSE,SCHRADER		1	\$	320.00
27537-03	ACCESSORY HOSE ASSY		1	\$	320.00
27537-04	HAN HK EXT DURATION HS,HK SKT		1	\$	217.40
27537-05	ACCESSORY HOSE RETAINER ASSY		1	\$	217.40
27537-06	ACSY HOSE RETAINER ASSY(SCHR)		1	\$	217.40
27537-08	CEJN ACC HOSE, ENAP50		1	\$	220.50

27537-11	ACCESSORY HOSE ASSY		1	\$	320.00
27537-12	ACCESSORY HOSE ASSY		1	\$	320.00
27537-13	ACCESSORY HOSE ASSY		1	\$	320.00
27537-14	ACCESSORY HOSE ASSY		1	\$	320.00
27540-02	MODIFICATION KIT 2.2		1	\$	209.00
27540-04	MODIFICATION KIT 4.5		1	\$	209.00
2827-52	GASKET .437ID, .750OD, .015TK		1	\$	3.20
29000-00	2216 30MIN ALUMINUM CYLINDER		1	\$	420.00
29005-01	SKA-PAK 2.2 5MIN ALUMINUM CYL		1	\$	280.00
29513-01	AV2 AUX EXHALATION VALVE KIT		1	\$	82.70
29586-01	HOSE, LOW PRESSURE		1	\$	109.20
29586-03	SKA-PAK LOW PRESSURE HOSE		1	\$	120.00
30000-00	HOSE, SUPPLY		1	\$	4.40
30010-003	SUPPLY HOSE		1	\$	100.00
30010-004	SUPPLY HOSE ASSEMBLY		1	\$	105.00
30010-006	6' SUPPLY HOSE,HANSEN		1	\$	120.00
30010-010	10' supply hose Hansen		1	\$	142.00
30010-025	25' SUPPLY HOSE,HANSEN		1	\$	190.00
30010-050	50' SUPPLY HOSE,HANSEN		1	\$	270.00
30010-100	100' SUPPLY HOSE,HANSEN		1	\$	420.00
30010-150	150 FT' SUPPLY HOSE W/HANS		1	\$	570.00
30010-300	SUPPLY HOSE, HANSON 300 FT		1	\$	1,000.00
30020-006	6' SUPPLY HOSE,SCHRADER		1	\$	120.00
30020-010	10' SUPPLY HOSE, SCHRADER		1	\$	140.00
30020-015	15' SUPPLY HOSE, SCHRADER		1	\$	180.00
30020-025	25' SUPPLY HOSE,SCHRADER		1	\$	190.00
30020-050	50' SUPPLY HOSE,SCHRADER		1	\$	270.00
30020-100	100' SUPPLY HOSE,SCHRADER		1	\$	420.00
30020-150	150' SUPPLY HOSE W/SCHR		1	\$	570.00
30020-300	SUPPLY HOSE ASSEMBLY		1	\$	1,000.00
31000006	LABEL, SERVICE, P/N & S/N		1	\$	2.30
31000013	SCREW, PAN HEAD, M4 THREAD		1	\$	1.00
31000015	10-32X1/2 LOW HD SOCKT CAP SCR	Service Item	11	\$	1.90
31000028	INTRINSIC SAFETY LABEL, EEOSTI		1	\$	3.00
31000042-01	WAIST PAD		1	\$	153.90
31000046	INLET, 4500		1	\$	166.40
31000047	RIGHT LATCH		1	\$	91.50
31000048	LEFT LATCH		1	\$	91.50
31000050	SPRING, COMPRESSION		1	\$	2.30
31000051	INSULATOR,INLET SWITCH CONN		1	\$	4.40
31000052	MANIFOLD		1	\$	162.20
31000053	MANIFOLD CAP		1	\$	155.00
31000054	POST, SWIVEL		1	\$	43.70
31000055	WASHER, SMALL SWIVEL		1	\$	4.00
31000056	SHAFT, PRESS TO TEST		1	\$	17.00
31000057	PLUG, LOW PRESSURE		1	\$	6.70
31000058	SEAT, AUTO-TRANSFER		1	\$	30.20
31000059	CAP,MANIFOLD END		1	\$	3.20
31000060	HOUSING, REDUCER,		1	\$	194.50
31000061	HIGH PRESSURE PLUG		1	\$	6.60
31000062	SLEEVE, 2.2 TRANSFER VALVE		1	\$	20.50
31000063	ELBOW, HIGH PRESSURE		1	\$	53.00
31000064	CHECK VALVE		1	\$	4.50
31000065	NOZZLE AIR PATH		1	\$	56.20
31000066	RETAINER, SWITCH WIRE		1	\$	3.87
31000068	SLEEVE, 4.5 TRANSFER VALVE		1	\$	30.20
31000072	ORIFICE PLATE		1	\$	5.20
31000073	LABEL, COVER, EZ FLO+		1	\$	12.50
31000103	PIN,CYLINDER LATCH		1	\$	2.50
31000118	RETAINER, SWIVEL FITTING		1	\$	12.50
31000120	RETAINER, FLOW CAP		1	\$	18.20

31000121	BUTTON, REDUCER POSITIONER		1	\$	4.70
31000123	SCREW,SEMS PAN HD,STAINLESS		11	\$	2.20
31000125	SCREW, POSITIONER		1	\$	7.50
31000126	SPRING, COMPRESSION		1	\$	2.30
31000143	PRESSURE TRANS 0-4500 PSI W/CA		1	\$	486.70
31000145	PLUG, MANIFOLD, LOW PRESSURE	Service Item	11	\$	1.80
31000158	LABEL, APPROVAL, INTRINSIC SAF		1	\$	2.40
31000170	POS PRESSURE SPRING, EZ FLO+		11	\$	2.20
31000179	GUARD, BATTERY HOUSING		1	\$	41.60
31000180	SCREW,HEX SOCKET,#6-20 TYPE B		1	\$	2.30
31000182	LABEL, NIOSH,SKA-PAK PLUS & AT	Service Item	1	\$	13.50
31000190	COUPLING FEMALE WAND, CHARGING		1	\$	619.80
31000197	PACKING, PREFORMED		11	\$	2.30
31000203	DETENT BALL, TI CAMERA		1	\$	4.00
31000205	DETENT PRES.SPRING,TI CAMERA		1	\$	4.20
31000206	PRES.ADJ.BOLT,TI CAMERA		1	\$	23.00
31000207	PRES.ADJ. WHEEL, TI CAMERA		1	\$	62.00
31000211	HANDLE,LEFT,EI,BAE-SERIES		1	\$	27.00
31000212	HANDLE,RIGHT,EI,BAE-SERIES		1	\$	28.00
31000218	GLARE SHIELD, EI,BAE-SERIES		1	\$	34.00
31000219	BOOT,HOUSING,EI,BAE-SERIES		1	\$	21.00
31000220	DISPLAY COVER, EI,BAE-SERIES		1	\$	39.00
31000225	LABEL,COVER EZ FLO + SWAT NO		11	\$	5.20
31000227	BARCODE LABEL FOR NXG2 EE ASY		1	\$	11.60
31000235	DECAL,CYLINDER WARNING,SKA-PAK		1	\$	4.40
31000238	SWITCH, EI 160		1	\$	36.00
31000240-01	BAE 160 CORE W/NO TEMP READOUT		1	\$	6,790.00
31000240-02	BAE 160 CORE W/ TEMP READOUT		1	\$	6,790.00
31000240-03	BAE 160 PAL CORE W/NO TEMP REA		1	\$	6,790.00
31000240-04	BAE 160 PAL CORE W/ TEMP REA		1	\$	6,790.00
31000240-05	CAMERA CORE ASM		1	\$	6,790.00
31000240-06	CAMERA CORE ASM		1	\$	6,790.00
31000240-07	CAMERA CORE ASM		1	\$	6,790.00
31000240-08	CAMERA CORE ASM		1	\$	6,790.00
31000240-09	CAMERA CORE ASM		1	\$	6,790.00
31000240-10	CAMERA CORE EI 160		1	\$	6,789.00
31000240-11	CAMERA CORE ASSEMBLY EI 160		1	\$	6,790.00
31000242	MOUNT BUSH,EAGLE 1B, TI CAMERA		1	\$	2.77
31000248	4-40 X .375 BUTTON HD CAP SCRE		11	\$	2.10
31000250	10-32 X .500 BUTTON HD CAP SCR		11	\$	2.30
31000251	DETENT PRESSURE SPRING GUIDE		1	\$	9.50
31000259	FITT,HOSE SWIV CONN W/STOP,BLK		1	\$	18.00
31000260	FASTENER,BROACHING.112-40 UNC		1	\$	2.60
31000273	BOOT,BATT COVER NXG2 AIR-PAK		1	\$	7.50
31000283	BATTERY CHARGER, EI 160		1	\$	358.00
31000284	LABEL,ELECT.ENC PASS/GAUGE ASY		1	\$	4.80
31000292	DISPLAY SUPPORT FOAM,RIGHT		1	\$	14.30
31000296	BOOT,RING,EI,BAE-SERIES		1	\$	17.00
31000298	CABL HARN,CMB TO SCC500,EI 160		1	\$	38.00
31000299	CABL HARN,ICB TO CMB, EI 160		1	\$	36.00
31000300	CABLE HARN,CMB TO I/O,EI 160		1	\$	55.00
31000301	CABLE HARN, SMB TO CMB, EI 160		1	\$	50.00
31000321	LCD,4" TFT COLOR,NTSC EI 160		1	\$	808.00
31000327	FITTING,BATTERY SHEATH MAIN EN		1	\$	15.00
31000335	LOCK PLATE		1	\$	4.00
31000345	CAP,PLUG FITTING, NXG2		1	\$	2.30
31000348	CARRY CASE, EAGLE 160		1	\$	339.00
31000353	HOUSING,TRANSDUCER,HUD MODULE		1	\$	3.25
31000354	BRACKET,MOUNTING,HUD MODULE		1	\$	8.50
31000355	BUSHING,MOUNTING,HUD MODULE		1	\$	2.40
31000362	HELICAL LOCK WASHER		11	\$	1.70

31000366	AC ADAPTER, EI 160		1	\$	79.00
31000374	PUSHBUTTON GUARD KIT		1	\$	31.35
31000380	CLIP,RETAINING,PRESSURE TRANS		1	\$	2.30
31000381	SCREW,PAN HD,PHILLIPS		1	\$	4.20
31000382	"U" PIN,GAUGE LINE		1	\$	2.30
31000384	LABEL,INT SAFETY,VISUALERT ASY		1	\$	3.20
31000389	INLET CAP		1	\$	37.40
31000390	CAP,SPRING		1	\$	7.40
31000391	INLET BUSHING		1	\$	3.25
31000397	PRESSURE TRANSDUCER		1	\$	228.80
31000401	LABEL,AIR-PAK,CBRN,RETROFIT		1	\$	4.90
31000407	BATTERY COVER		1	\$	24.00
31000408	GERMANIUM LENS COVER		1	\$	14.70
31000409	GERMANIUM LENS		1	\$	335.00
31000410	LCD 3.5" (ACAD)		1	\$	973.00
31000411	WIRING SEAL		1	\$	20.00
31000412	COVER,LCD		1	\$	27.00
31000415	HARNESS RING-NECK STRAP ATTACH		5	\$	2.10
31000416	BAE CORE ASSY,HORIZONTAL		1	\$	4,961.86
31000419	GASKET,BATTERY COVER		1	\$	20.00
31000428	#4-40X.5 SOCKET HD CAP SCREW		11	\$	1.25
31000434	5/16-32 HEX NUT,NXG2 LED ASY		1	\$	2.30
31000435	BATTERY TRUCK CHARGER, EI 160		1	\$	498.00
31000443	PRESSURE TRANSDUCER		1	\$	272.50
31000445	LABEL,APPROVAL,INTRINSIC SAFE		11	\$	2.30
31000448	O-RING, PARKER 2-028		1	\$	1.10
31000456	HOUSING COMPLETE,RIGHT		1	\$	107.00
31000458	HOUSING COMPLETE,LEFT		1	\$	129.00
31000465	LCD RUBBER CENTERING BLOCKS		1	\$	7.40
31000487	BUTYL PAPER HOOD,SMALL		1	\$	297.90
31000488	DC ADAPTER, TCS, EI 160		1	\$	113.00
31000490	VIDEO TRANSMITTER,2-CHANNEL		1	\$	983.00
31000492	SCREW,1/4-20X5/8 LG SOCKET		1	\$	2.30
31000495	BATTERY COVER GASKET		1	\$	4.20
31000498	RETAINING RING		1	\$	0.30
31000520	BUTYL PAPER HOOD,LARGE		1	\$	297.90
31000521	DRAW LATCH, EI160 TCS		1	\$	40.00
31000534	SHROUD,DEMANDLEVER,W/RETAINER		1	\$	4.20
31000540	RETAINER RING,SCREW		1	\$	2.20
31000553	TEE,1/4 NPT,FEMALE THREAD		1	\$	106.10
31000554	NIPPLE,1/4 NPT,COUPLING		1	\$	52.00
31000555	BATTERY CONTACT		1	\$	39.00
31000556	CHARGER CONTACT STRIP		1	\$	39.00
31000559	TI 160 CAMERA LABEL/BAE SYSTEM		1	\$	2.10
31000565	NIMH BATTERY ASSEMBLY		1	\$	97.00
31000574	CAMERA HSG,FRONT,EMI COATING		1	\$	86.00
31000575	CAMERA HSG,BACK,EMI COATING		1	\$	86.00
31000576	LCD SHIELD,EI 160		1	\$	24.00
31000577	RING,RETAINING,EXT "E", 1/4"		1	\$	2.20
31000578	PROFLOW DUFFLE BAG		1	\$	43.90
31000602	O-RING CORD,0.07DIA,SILICONE		1	\$	3.20
31000605	O-RING,SPARE,HUD TRANSDUCER		1	\$	5.90
31000635	CORE ISOLATOR		1	\$	33.00
31000640	CAMERA HSG,FRONT,EMI SHIELD		1	\$	79.00
31000641	CAMERA HSG,BACK,EMI SHIELDING		1	\$	94.00
31000642	SHOCK ISOLATION PAD		1	\$	24.00
31000643	SHOCK ISOLATOR,TOP,LCD		1	\$	5.20
31000644	SHOCK ISOLATOR,SIDE,LCD		1	\$	5.20
31000647	LABEL,COVER,EZ FLO II+		1	\$	4.80
31000673	EI 160 SECURING RUBBER BLOCKS		1	\$	2.00
31000674	MOUNT FRICTION WASHER		1	\$	7.50



31000676	EAGLE X CAMER BATTY BAS CHRGR		1	\$	160.00
31000678	EAGLE X LOGO LABEL		1	\$	3.18
31000686	EAGLE X CAMERA TRK BATT CHARGR		1	\$	160.00
31000687	CARRYING CASE EAGLE X		1	\$	305.00
31000688	PLUG		1	\$	17.00
31000689	WIRE,EXTERNAL RETAINER		1	\$	5.40
31000698	8-32 X .375 HEX SOC BUTTON SCR		1	\$	1.80
31000714	VELCRO RETAINING STRAP FOR TCS		1	\$	7.30
31000805	PLATE,IDENTIFICATION(GENERIC)		1	\$	9.80
31000973	RELIEF VALVE, 2.2		1	\$	114.40
31000974	RELIEF VALVE, 3.0		1	\$	84.20
31000975	RELIEF VALVE, 4.5		1	\$	84.20
31001002	O-RING, .945 X .079, 70 DUR A		1	\$	2.10
31001012	LABEL APPROV INTRINSIC SAFE		1	\$	6.50
31001025	POWER CORD, INT'L EUROPE		1	\$	14.00
31001029	POWER CORD, INT'L AUS/NZ		1	\$	8.59
31001041	HOUSING,BOTTOM,CONSOLE		1	\$	26.50
31001043	NOSECUP, AV3000 SMALL		1	\$	41.10
31001044	NOSECUP, AV3000 MEDIUM		1	\$	41.10
31001045	NOSECUP, AV3000 LARGE		1	\$	41.10
31001087	BATTERY DOOR SERVICE KIT W/SCR		1	\$	41.80
31001088	GASKET,BRACKET MOUNT SERVICE K		1	\$	30.31
31001089	THUMB LATCH DETENT SERVICE KIT		1	\$	38.67
31001090	BATTERY DOOR, EPIC RI AMP		1	\$	49.12
31001093	ALLIGATOR BELT CLIP, EPIC RI		1	\$	64.79
31001094	CLOTHES PIN BELT CLIP, EPIC RI		1	\$	64.79
31001097	GASKET, EPIC RI LAPEL MIC		1	\$	56.43
31001098	BATTERY DOOR, EPIC RI LAPEL MI		1	\$	53.30
31001101	AAA BATTERY SLED, EPIC RI		1	\$	56.43
31001110	SCREW, SH, PAN HD, PHILLIPS		1	\$	10.50
31001115	BODY,PRESSURE REDUCER		1	\$	660.40
31001118	RETAINER, HOSE	Service Item	1	\$	6.90
31001123	PIN,GAUGE LINE	Service Item	11	\$	1.10
31001124	PLUG, MANIFOLD	Service Item	1	\$	7.90
31001125-010	SUPPLY HOSE, PCL		1	\$	150.00
31001125-025	SUPPLY HOSE, PCL		1	\$	220.00
31001125-050	SUPPLY HOSE, PCL		1	\$	320.00
31001140	PLATE, IDENTIFICATION		1	\$	2.30
31001150-01	MOLDED CABLE ASSY,HUD ONLY		1	\$	189.30
31001150-02	MOLDED CABLE ASSY,HUD/PASS		1	\$	348.40
31001150-03	MOLDED CABLE ASSY,AIR-PAK		1	\$	347.99
31001150-04	MOLDED CABLE ASSY,AIR-PAK		1	\$	348.40
31001150-05	MOLDED CABLE ASSY,HUD/PASS		1	\$	310.00
31001180	2007 RIC UAC BOOT		1	\$	23.80
31001202	BATTERY CONNECTOR		1	\$	54.10
31001207	HOSE, FLOWHOOD		1	\$	54.10
31001221	MANIFOLD,HOUSING		1	\$	54.10
31001223	BUTTON, REDUCER		1	\$	8.10
31001229	PLUG		1	\$	8.10
31001230	HOUSING, REDUCER		1	\$	660.40
31001231	BLOCK,HOSE		1	\$	69.70
31001232	RETAINER,HOSE BLOCK		1	\$	23.70
31001238	CLIP,CABLE,ALUM,FRAME		11	\$	1.80
31001239	CLIP,CABLE,WIRE FRAME		1	\$	1.80
31001242	BRACKET,SENSOR MODULE		1	\$	28.22
31001250	ADAPTER,FEMALE		1	\$	26.10
31001255	#17 O-RING (VITON)		1	\$	1.80
31001256	NOSECUP,AV2000,ASSEMBLY		1	\$	53.10
31001262	O-RING,COVER SCREW,2007		11	\$	1.46
31001265	O-RING, RECEPTACLE		1	\$	1.80
31001277	POST, BATTERY HOUSING, 2007	Service Item	1	\$	8.10

31001287	SEAL,BATTERY COVER, 2007		11	\$	2.19
31001288	COVER SCREW,SENSOR HOUSING,200		1	\$	9.93
31001290	E-CLIP,SENSOR,2007		11	\$	1.67
31001298	CLIP,RETENTION		1	\$	17.00
31001319	HOUSING, CHECK VALVE	Service Item	1	\$	132.10
31001331	MOLDED CABLE ASSY, NXG7		1	\$	400.24
31001333	CABLE ASY,PRES.RED.HIGH TEMP		1	\$	47.80
31001336	TRACKER LABEL,PIEZO COVER, 200		1	\$	1.40
31001348	CYLINDER CARBON 45MIN (JAPAN)		1	\$	1,170.00
31001362	LABEL,NFPA-2007,AIR-PAK 4.5,3.		1	\$	8.10
31001363	LABEL,NFPA-2007,AIR-PAK NXG7		1	\$	8.10
31001364	LABEL,PASS APPROVAL,NFPA 2007		1	\$	1.85
31001371	SOFTWARE CD,WIRELESS BOOT LOAD		1	\$	182.88
31001384	PLUG	Service Item	1	\$	4.50
31001402	ELBOW,GAUGE LINE		1	\$	72.00
31001414	PIN,RIC BOOT		1	\$	12.50
31001415	FD-7 BOOT,02 RIC UAC		1	\$	45.00
31001418	"U" PIN		1	\$	1.80
31001429	HOOD ASSY, FH2		1	\$	47.00
31001450	LABEL, 4.5 REDUCER COVER	Service Item	1	\$	10.60
31001451	LABEL, 3.0 REDUCER COVER		1	\$	10.60
31001452	LABEL, 2.2 REDUCER COVER	Service Item	1	\$	10.60
31001465	APPLICATOR, MANUAL ADHESIVE		1	\$	119.60
31001466	STATIC MIXER		1	\$	4.30
31001473	LABEL, NXG7 4.5		1	\$	7.10
31001493	MTG. NUT, NARROW,RECEPTACLE		1	\$	1.80
31001504	BATTERY, NIMH, C420 PLUS		1	\$	197.90
31001506	END CAP, NIMH BATTERY, C420+		1	\$	27.60
31001508	LABEL, NXG7 2.2	Service Item	1	\$	7.10
31001535	SEAL,SILICONE,ONE RIB,HUD QD		1	\$	6.10
31001536	SCREW,#10-32X3/8,SOC BUTT HD		1	\$	2.20
31001539	BATTERY SEPARATOR,SENSOR 2007	Service Item	1	\$	8.15
31001541	ADAPTER,NIPPLE TO MALE THREAD		1	\$	34.30
31001548	LABEL,NIOSH,CBRN,AP,4.5,3.0,2		1	\$	8.10
31001549	LABEL,NIOSH,CBRN,NXG,4.5,2.2		1	\$	8.10
31001550	BATTERY DOOR LATCH SCREWS, SER		1	\$	30.31
31001558	HUB, SLIDER		1	\$	4.30
31001563	CAPLUG,1/2" TEAR		1	\$	0.30
31001568-04	TUBING,HEAT SHRINK,HUD 3" (10)		1	\$	9.70
31001568-05	TUBING,HEAT SHRINK,HUD3.5"(10)		1	\$	11.00
31001575	PTT COVER, EPIC RI		1	\$	16.72
31001579	SOFTWARE CD,SEMS II FOR 200732		1	\$	642.00
31001582	CYL,BASE,CARB,ST7,30MIN, 4500		1	\$	1,110.00
31001583	CYL,BASE,CARB,ST7-45M-4500PSI		1	\$	1,380.00
31001584	CYL,BASE,CARB,ST7-60M-4500PSI		1	\$	1,460.00
31001613	RTV,DOW CORNING 3-1744 APP KIT		1	\$	62.00
31001614	Y MANIFOLD		1	\$	80.47
31001615	COVER, SEMS II HOUSING		1	\$	60.61
31001626	LABEL, BATTERY ISOLATOR		111	\$	0.54
31001628	CABLE HARNESS, CORE INTERFACE		1	\$	76.09
31001632	CLAMP,CABLE		1	\$	9.20
31001650	UPGRADE LABEL, AP2002 TO 2007		1	\$	4.60
31001651	LABEL, UPGRADE NFPA-2007,NXG2		1	\$	8.30
31001669	GASKET, HOUSING		1	\$	17.00
31001702	GAKET, EPIC RI AMP		1	\$	5.54
31001712-01	CYL,CARB, 60M4500,SAR-NAVY		1	\$	1,710.00
31001744	PIN, PIVOT		1	\$	3.60
31001745	RETAINING SPRING		1	\$	3.70
31001746	WINDOW, DISPLAY		1	\$	50.00
31001749	SWITCH PUSH BUTTON, GREEN		1	\$	42.00
31001773	CAPPLUGS, 20/BAG		1	\$	26.60

31001861-02	SEAL, HOUSING, SILVER		1	\$	22.00
31001873	CABLE, ANETANNA TO LOC, EI 320		1	\$	3.54
31001875	WESTCODYNE PLUS 4 X 1G		1	\$	206.90
31001876	WESTCODYNE PLUS 6 X 16 OZ		1	\$	143.90
31001890	LENS COVER, TACTICAL TIC		1	\$	6.60
31001891	LENS SEAL, TACTICAL TIC		1	\$	11.50
31001892	CORE RETAINER,BTM,TACTICAL TIC		1	\$	0.67
31001893	CORE RETAINER, TOP,TACTICAL TIC		1	\$	0.67
31001896	VENT VALVE		1	\$	1.41
31001898	SOCKET HEAD SHOULDER BOLT		1	\$	6.11
31001900	PCB,LCD BRACKET,TACTICAL TIC		1	\$	0.99
31001901	PCB BRACKET,TACTICAL TIC		1	\$	0.81
31001904	2.5 TFT-LCD MODULE		1	\$	229.00
31001905	RETAINER SCREW		1	\$	20.00
31001906	LCD WINDOW, TACTICAL TIC		1	\$	39.00
31001907	LCD SEAL, TACTICAL TIC		1	\$	19.00
31001912	BATTERY RETAINER BRACKET		1	\$	2.44
31001913	BATTERY CLIP		1	\$	7.40
31001914-01	LENS COVER, TACTICAL TIC,RED		1	\$	22.00
31001914-02	LENS COVER,TACTICAL TIC,ORG		1	\$	31.00
31001914-03	LENS COVER, TACTICAL TIC,YEL		1	\$	31.00
31001914-04	LENS COVER, TACTICAL TIC,BLK		1	\$	22.00
31001915-01	LCD COVER,TACTICAL TIC,RED		1	\$	32.00
31001915-02	LCD COVER,TACTICAL TIC,ORG		1	\$	39.00
31001915-03	LCD COVER,TACTICAL TIC,YEL		1	\$	39.00
31001915-04	LCD COVER,TACTICAL TIC,BLK		1	\$	32.00
31001915-11	LCD CVR,TAC TIC,RED,GLARE SHLD		1	\$	45.00
31001915-12	LCD CVR,TACTIC,ORAN,GLARE SHLD		1	\$	53.00
31001915-13	LCD CVR,TAC TIC,YEL,GLARE SHLD		1	\$	53.00
31001915-14	LCD CVR,TAC TIC,BLK,GLARE SHLD		1	\$	45.00
31001916-01	BATTERY BUMPER,TAC TIC,RED		1	\$	32.00
31001916-02	BATTERY BUMPER,TAC TIC,ORG		1	\$	39.00
31001916-03	BATTERY BUMPER,TAC TIC,YEL		1	\$	39.00
31001916-04	BATTERY BUMPER,TAC TIC,BLK		1	\$	32.00
31001917	HANDLE, RIGHT, TACTICAL TIC		1	\$	28.00
31001918	HANDLE, LEFT, TACTICAL TIC		1	\$	28.00
31001919	HANDLE PCB SEAL, TACTICAL TIC		1	\$	4.38
31001921	BATTERY, RETAINER RING		1	\$	1.10
31001943-01	LABEL, CYLINDER-WARNING 4500		1	\$	4.00
31001943-02	LABEL, CYLINDER-WARNING 3000		1	\$	4.00
31001943-03	LABEL, CYLINDER-WARNING 2216		1	\$	4.00
31001951	BOOT, FILL, NXG		1	\$	23.40
31001960	MANIFOLD, ACS EXT DURATION		1	\$	245.00
31001961	MANIFOLD COVER, ACS EXT DUR		1	\$	115.00
31001962	CHECK VALVE, MALE, 1/4" NPT		1	\$	175.00
31001972	BLEED VAVLE		1	\$	160.00
31001973	RESP MANIFOLD OUTLET GAUGE	Service Item	1	\$	67.00
31001974	HANSEN COUPLING		1	\$	78.00
31001975	SCHRADER COUPLING		1	\$	110.00
31001976	SS FOSTER COUPLING		1	\$	150.00
31001977	RESP REGULATOR INLET GAUGE		1	\$	150.00
31001978	LOW PRESSURE WHISTLE		1	\$	610.00
31001979	8" SEMI-PNEUMATIC WHEEL		1	\$	67.00
31001980	TOOL OUTLET GAUGE		1	\$	43.00
31002001	QUICK RELEASE BELT HOLDER		1	\$	100.90
31002002	QUICK RELEASE STRAP		1	\$	197.60
31002004	SINGLE POUCH		1	\$	138.30
31002005	DOUBLE POUCH		1	\$	197.60
31002006	F4 DESCENT DEVICE		1	\$	205.90
31002010	FIRE-AL DESCENT DEVICE ASY,RIT		1	\$	329.70
31002011	CARABINER LINK,RIT		1	\$	77.00

31002012	WEBBING LOADING TOOL,RIT		1	\$	16.60
31002013	50'WEBBING CARTRIDGE,RIT		1	\$	40.60
31002014	75'WEBBING CARTRIDGE,RIT		1	\$	47.80
31002016	ADAPTOR, NXG2 RELIEF VALVE		1	\$	41.60
31002040	HANGER, CYLINDER VALVE		1	\$	30.00
31002042	plug		1	\$	3.90
31002043	RETAINER, HIGH PRESSURE		1	\$	28.50
31002044	RETAINER, SEAT	Service Item	1	\$	54.10
31002045	PLUG, ADJUSTMENT	Service Item	1	\$	27.00
31002046	SEAT	Service Item	1	\$	27.00
31002047	PISTON		1	\$	109.00
31002048	PISTON	Service Item	1	\$	113.40
31002052	SLEEVE, 2.2 TRANSFER VALVE	Service Item	1	\$	20.50
31002055	SLEEVE, 4.5 TRANSFER VALVE	Service Item	1	\$	20.50
31002056	TRANSFER VALVE, 5.5		1	\$	3.25
31002057	SLEEVE, 5.5 TRANSFER VALVE	Service Item	1	\$	20.50
31002058	SLEEVE, 2.2 TRANSFER VALVE(NXG)		1	\$	20.50
31002059	SLEEVE, 35%, 2216 PSI TRANS VALV		1	\$	23.25
31002060	SLEEVE, 4.5 TRANSFER VALVE(NXG)		1	\$	20.50
31002061	SLEEVE, 35%, 4500 PSI TRANS VALV		1	\$	23.25
31002062	SLEEVE, 5.5 TRANSFER VALVE(NXG)		1	\$	20.50
31002063	SLEEVE, 35%, 5500 PSI TRANS VALV		1	\$	23.25
31002064	PACKING, PREFORMED	Service Item	1	\$	4.50
31002065	PACKING, PREFORMED	Service Item	1	\$	4.50
31002066	PACKING, PREFORMED	Service Item	1	\$	4.50
31002067	NOZZLE, AIR PATH		1	\$	27.00
31002068	PIN, LATCH LOCK		1	\$	25.20
31002069	SPRING, COMPRESSION		1	\$	2.20
31002071	SLEEVE, 2.2 INLET		1	\$	23.50
31002072	PIN, LOCK		1	\$	25.20
31002073	BUSHING		1	\$	3.70
31002074	PLATE, RETAINER		1	\$	18.00
31002075	SCREW, FH, 8-32X1/2		1	\$	1.70
31002076	RING PULL		1	\$	40.00
31002077	HOUSING, 2.2 INLET		1	\$	100.00
31002078	HOUSING, 4.5 INLET		1	\$	100.00
31002079	HOUSING, 5.5 INLET		1	\$	100.00
31002083	SLEEVE, 4.5 INLET		1	\$	23.50
31002084	SLEEVE, 5.5 INLET		1	\$	23.50
31002085	RELIEF VALVE, 5.5		1	\$	162.20
31002086	LABEL, 5.5 REDUCER COVER	Service Item	1	\$	10.60
31002087	BODY, PRESSURE REDUCER	Service Item	1	\$	660.40
31002088	HOUSING, REDUCER, NXG		1	\$	660.40
31002089	INLET HOUSING, 2.2		1	\$	162.20
31002090	INLET HOUSING, 4.5		1	\$	162.20
31002091	INLET HOUSING, 5.5		1	\$	162.20
31002095	PROBE, 5500 PSI		1	\$	86.30
31002096	PACKING, PREFORMED	Service Item	1	\$	4.50
31002100	PACKING, PREFORMED	Service Item	1	\$	4.50
31002105	HOUSING, REDUCER		1	\$	665.29
31002108	BEARING, WEAR		1	\$	20.00
31002109	PLUG		1	\$	5.00
31002110	PIN PLUG		1	\$	4.50
31002111	PLUG		1	\$	5.00
31002114	PLUG, HIGH PRESSURE		1	\$	5.00
31002115	LABEL, REDUCER IDENT. (2.2)		1	\$	10.20
31002116	BUTTON, REDUCER		1	\$	5.00
31002118	POST, SWIVEL		1	\$	12.00
31002119	SPACER SWIVEL		1	\$	5.00
31002121	BUTT SPLCE, RAYCHEM D1744-01		1	\$	3.60
31002121-10	BUTT SPLCE, RAYCHEM D1744-01(20		1	\$	63.30

31002129	FLASHLIGHT, STREAMLIGHT TLR-1		1	\$	192.50
31002142	SCREW#4X 25PAN HD.SELF LOCKING		1	\$	0.20
31002147	SCREW6-32X.275SH SELF LOCKING		1	\$	0.20
31002155	PLATE, SUPPORT		1	\$	23.87
31002170	REDUCER MOUNTING PLATE,RIT-PAK		1	\$	16.60
31002181	SHOCK BUMPER, IMAGER CORE		1	\$	8.28
31002191	PROTECTIVE BAND, KUNKLE VALVE	Service Item	1	\$	2.10
31002196	CAMERA RETAINER LEFT		1	\$	2.32
31002197	CAMERA RETAINER RIGHT		1	\$	2.32
31002204	DVR CONNECTION CABLE		1	\$	40.00
31002205	DVR INTERCONNECT CABLE		1	\$	10.50
31002216	ATTACK TVR DOWNLOAD CABLE		1	\$	89.00
31002217	CAMERA SERVICE ADAPTER		1	\$	8.59
31002218	TAC-TIC LCD CABLE		1	\$	11.34
31002221	CARRY CASE, PAPR		1	\$	232.60
31002234	BATTERY RETAINER LATCH		1	\$	8.40
31002235	TAC-TIC POWER/CORE CABLE		1	\$	28.61
31002254	DUAL CHARGER PCB		1	\$	90.58
31002261	O-RING PACKING,PREFORMED		1	\$	0.20
31002262	O-RING, KUNKLE VALVE		1	\$	0.40
31002265	ACCESSORY LIGHT MOUNT		1	\$	19.00
31002269	NYLOCK NUT,#10-32,SELF LOCKING		1	\$	0.13
31002270	CAP, CLOSURE, M12		1	\$	12.30
31002272	2-28 X .625 TRILOBE SCREW		1	\$	0.08
31002275	LABEL,FIELD SERV. REPL. 2 X .5		1	\$	2.00
31002284	USB DOWNLOAD POWER ADAPTER		1	\$	32.00
31002286	LABEL,KAPTON,PROD, 2 X .5		1	\$	0.25
31002289	LABEL,BARCODE,FIELD SERV.,.5X.5		1	\$	0.20
31002290	LABEL, NIOSH CBRN AP 5.5	Service Item	1	\$	8.00
31002294	LOCTITE 598,BLACK RTV SILICONE		1	\$	14.77
31002295	RED GLPT INSULATING VARNISH		1	\$	31.20
31002299	CYL,CARBON WRAP-30 MIN 5500PSI		1	\$	930.00
31002300	CYL,CARBON WRAP-45 MIN 5500PSI		1	\$	1,320.00
31002301	CYL,CARBON WRAP-60 MIN 5500PSI		1	\$	1,510.00
31002302	CYL,CARBON WRAP-75 MIN 5500PSI		1	\$	1,620.00
31002303	SPLIT HARNESS RING		1	\$	0.76
31002307	RUBBER BUMPER, TACTICAL TIC		1	\$	0.38
31002319	LABEL,MASK,FIELD SERV.,REPLACE		31	\$	0.30
31002320	TAPERED SHANK FASTENER,TAC-TIC		1	\$	5.51
31002321	FLAT RING SEAL, TACTICAL TIC		1	\$	0.19
31002325	PRESS-TO-TEST		1	\$	5.30
31002327	SNAP RING, INTERNAL		1	\$	3.50
31002331	LABEL,REDUCER IDENT (5.5)		1	\$	10.20
31002333	SEAT, AUTO-TRANSFER		1	\$	29.00
31002352	PACKING,PREFMD,SERV.SPARE,FD17	Service Item	1	\$	5.00
31002358	LABEL,NIOSH,NAVY WIREFRAME	Service Item	1	\$	8.00
31002359	RETAINER, CYLINDER BRACKET		1	\$	25.00
31002361	BATTERY CAP, C420+ PAPR		1	\$	28.10
31002364	MOUNT, RELIEF VALVE		1	\$	25.00
31002365	LABEL,REDUCER IDENT (4.5)		1	\$	10.20
31002366	PACKING,PREFORMED		1	\$	4.30
31002368	PACKING,PREFORMED		1	\$	4.30
31002370	TRUCK BAT CHARGE BOARD, EGLE X		1	\$	225.00
31002374	MOUNT BASE PLATE, EAGLE "X"		1	\$	31.00
31002483	SKA-PAK NIOSH CYL LBL 3-5MIN		1	\$	5.25
31002486	PACKING, PREFORMED		1	\$	1.55
31002495	SEAL,MOUNT,EPIC 3		1	\$	3.00
31002534	PACKING,PREFORMED		1	\$	0.55
31002535	PACKING,PREFORMED		1	\$	0.70
31002544	COVER, SHROUD, AIR-PAK X3		1	\$	30.00
31002546	SPRING CLIP,CYLINDR HANDLE, X3		1	\$	3.00

31002549	CLEVIS POST,MALE AIR-PAK X3		1	\$	8.50
31002550	CLEVIS POST,FEMALE AIR-PAK X3		1	\$	8.50
31002570	SPRING, COMPRESSION		1	\$	1.85
31002571-01	X3, CONSOLE HOUSING, FRONT		1	\$	30.00
31002571-02	X3, CONSOLE HOUSING,FRONT SEMS		1	\$	30.00
31002572	X3, PASS CONSOLE, HOUSING,REAR		1	\$	10.00
31002579	X3 SEMS CONSOLE,HOUSING,REAR		1	\$	10.00
31002582	SPRING, COMPRESSION		1	\$	1.85
31002618	LABEL, X3,NFPA 2013 BACKFRAME	Service Item	1	\$	8.00
31002620	LABEL,,X3,NIOSH-CBRN,2.2 CGA	Service Item	1	\$	8.00
31002636	GRILL, AV3000 HT		1	\$	6.50
31002637	GRILL,AMP,AV3000 HT, RIGHT		1	\$	6.57
31002639	ADAPTER,COMM,AV3000 HT, RIGHT		1	\$	8.08
31002659	LABEL,IDENTIFICATION,X3,SEMS		1	\$	3.00
31002660	LABEL,IDENTIFICATION,X3,PASS		1	\$	3.00
31002667	SCREW,SFHCS,8-32X5/16		1	\$	0.80
31002676	SCREW,TRILOBULAR,#6-19,.50 LG		1	\$	1.60
31002677	POST,BATT.HOUSING,SENSOR MOD.		1	\$	8.50
31002681	SENSOR MODULE COVER, X3		1	\$	45.00
31002682	CAP,BATTERY,SENSOR MODULE,X3		1	\$	20.00
31002699	LABEL,BARCODE,SENSOR MODULE,X3		1	\$	3.00
31002730	TRI-SLIDE, 1-1/2" X 5/16" SLOT		1	\$	3.00
31002759	LABEL,,X3,NIOSH-CBRN,4.5 CGA	Service Item	1	\$	8.00
31002760	LABEL,,X3,NIOSH-CBRN,5.5 CGA	Service Item	1	\$	8.00
31002772	LABEL, IS, PASS, 2013		1	\$	6.50
31002773	LABEL,WARNING, SENSOR X3		1	\$	6.50
31002774	LABEL,PASS APPROVAL,NFPA 2013		1	\$	6.50
31002785	LABEL,X3,NIOSH-CBRN,2.2 SNAP	Service Item	1	\$	8.00
31002786	LABEL,X3,NIOSH-CBRN,4.5 SNAP	Service Item	1	\$	8.00
31002787	LABEL,X3,NIOSH-CBRN,5.5 SNAP	Service Item	1	\$	8.00
31002788	VALVE, INHALATION RED		1	\$	4.10
31002790	BAND, COMM, AV3000 HT, RIGHT		1	\$	12.12
31002791	BAND, COMM, AV3000 HT, LEFT		1	\$	42.42
31002808	SCREW, SHOULDER		1	\$	8.00
31002809	BEZEL, UPPER, AV3000 HT		1	\$	9.50
31002810	BEZEL, LOWER, AV3000 HT		1	\$	15.00
31002815	SWIVEL,HIGH PRESSURE HOSE		1	\$	125.00
31002823	NXG AIR PATH WRENCH		1	\$	176.80
31002868	WASHER,#4 FLAT, SS		31	\$	0.30
31002916	SCREW,PH 6-32X1/2 SS NYL PATCH		1	\$	1.00
31002920	SCREW,PAN HD,2-56X1/2,SS,BLK		1	\$	6.75
31002942	SCREW PIVOT		1	\$	7.50
31002946	POST, PIVOT		1	\$	9.00
31002958	HP PLUG, #4 HEX HD WITH O-RING		1	\$	2.60
31002959	HANDLE, MOBILE AIR CART		1	\$	370.00
31002960	PIN,HANDLE CLEVIS, AIR CART		1	\$	35.00
31002961	LANYARD CABLE, HANDLE, AIR CAR		1	\$	5.00
31002962	LANYARD ATTACH RING, AIR CART		1	\$	2.00
31003020	LUBRICANT, SIL GREASE, SPARE		1	\$	53.69
31003025	ASSEMBLY,HEAD(NEW STYLE)		1	\$	1,015.00
31003026	KNOB,HEAD MOUNTING POSI-CHECK		1	\$	3.50
31003027	STANDOFF,INSERT,MOLDED POSI		1	\$	9.50
31003028	SHEET,INSTRUCTION,INSTALL PO		1	\$	2.50
31003029	GASKET, POSI CHEK, HEAD		1	\$	13.00
31003030	HEAD, POSI		1	\$	1,120.00
31003031	TUBING,TYGON,1/8ID,1/4 OD		1	\$	2.50
31003032	KIT US EXTERNAL MANIFOLDS POSI		1	\$	1,650.00
31003033	KIT,SPARE FUSE,POSI3 USB,110		1	\$	6.50
31003034	MANIFOLD,LO PRESSURE,2200 PSI		1	\$	785.00
31003035	MANIFOLD,HI PRESSURE,4500 PSI		1	\$	1,015.00
31003036	POWER CORD,BELDEN 17504IN BLA		1	\$	20.00

31003037	SOFT TIP,2250 PSI,WESTERN# 6		1	\$	11.00
31003038	NIPPLE,O-RING,WESTERN #6347-		1	\$	3.50
31003039	SCREW,RETAINING,WESTERN#SS63		1	\$	12.00
31003040	MYLAR FRONT PANEL POSI 3 USB S		1	\$	35.00
33220-01	NUT, NYLON LOCK, 1/4-28		1	\$	5.20
33316-014	SCREW, FLAT HD.,312X#4		1	\$	1.71
33324-001	SCREW, PAN HEAD .125 X #2		1	\$	2.50
33324-002	SCREW, PAN HEAD .188 X #2		11	\$	1.50
33324-005	SCREW, PAN HEAD		1	\$	0.20
33324-014	SCREW, PAN HEAD .312 X #4		1	\$	1.50
33324-015	SCREW, PAN HEAD #4-40X.375,SS		1	\$	1.90
33324-021	SCREW, PAN HEAD 1.000 X #4		1	\$	1.90
33324-028	SCREW, PAN HEAD .375 X #6		1	\$	2.30
33324-029	SCREW, PAN HEAD (10)		1	\$	3.50
33324-032	SCREW,PAN HEAD PHILLIPS #6-32		1	\$	1.80
33324-041	SCREW PAN HD .164 X .250		1	\$	1.60
33324-123	SCREW, PAN HEAD #6-32 X 9/16		1	\$	1.70
33335-022	SCREW, CAP, SOCKET HEAD		1	\$	2.70
33354-004	SCREW		1	\$	2.10
33354-016	SCREW, TAPPING.312 X #6		1	\$	2.50
33361-008	SCREW, CAP, SOCKET HEAD		1	\$	1.80
33361-009	SCREW,CAP,SOCKET HD 4-40X250		11	\$	2.30
33361-010	SCREW-CAP HEAD .375 X #4	Service Item	1	\$	2.50
33361-011	SCREW-CAP HEAD .5 X #4-40		11	\$	2.40
33361-017	SCREW-CAP HEAD .375 X #6	Service Item	1	\$	2.50
33361-020	SCREW,CAP,SOCKET HEAD		11	\$	2.20
33361-026	SCREW,CAP,SOCKET HEAD		1	\$	1.80
33361-047	SCREW-CAP HEAD .375 X .250		11	\$	2.50
33361-048	SCREW,CAP,SOCKET HD, 1/4 X 1/2		11	\$	0.40
33361-050	SCREW,1/4-20X.75LONG		11	\$	2.30
33361-055	SCREW,CAP,SOCKET HD1/4-20X1.75		1	\$	1.25
33362-006	SCR-RDH THD TYPE A 2-32 X .63		1	\$	2.30
33365-204	SCREW,SELF-TAPPING 6X.375 FLHD		1	\$	2.30
33460-069	LOCK WASHER-#2		1	\$	0.40
33460-071	LOCK WASHER (MS35333-71)		1	\$	0.40
33460-072	LOCK WASHER-#8		1	\$	2.40
33461-058	#6 LOCKWASHER		1	\$	2.20
33481-003	PIN,SPRING .062OD X .250L		11	\$	0.60
33481-004	PIN-SPRING .062OD X .312L	Service Item	1	\$	2.50
33481-007	PIN-SPRING .062OD X .500L	Service Item	1	\$	2.50
33481-107	PIN-SPRING .078OD X .500L		1	\$	2.40
33481-213	PIN-SPRING .094OD X .875L		11	\$	1.10
33481-307	PIN-SPRING		1	\$	0.20
33481-311	PIN-SPRING		1	\$	1.25
33488-003	CLAMP LOOP-STEEL PLAIN/CUSHION		1	\$	4.70
33488-004	CLAMP LOOP-STEEL PLAIN/CUSHION		1	\$	4.70
33488-034	CLAMP LOOP-STEEL PLAIN/CUSHION		1	\$	3.60
33602-098	RING,RETAINING,INTERNAL,BASIC	Service Item	1	\$	4.80
3502-01	WASHER,THRUST		1	\$	2.80
3502-02	WASHER,THRUST		1	\$	2.80
3502-03	WASHER,THRUST		1	\$	2.80
3504-01	WASHER,SPACER		1	\$	7.10
36176-00	PACKING PREFORM		1	\$	3.10
36477-00	PACKING PREFORM		1	\$	3.35
36596-28	DISC,BURST .0062 THICKNESS		1	\$	2.40
36596-35	DISC,BURST .0078 THICKNESS		1	\$	2.40
36596-48	DISC,BURST .0098 THICKNESS		1	\$	2.25
36596-50	DISC, BURST .0110 THICKNESS		1	\$	2.40
36596-72	DISC,BURST .0135 THICKNESS		1	\$	2.30
36682-01	SCREW,SELF-TAPPING,TRUSS HEAD	Service Item	1	\$	2.90
36682-03	SCREW,SELF TAPPING,TRUSS HD		1	\$	2.20

36683-02	SCR,SELF-TAPPING,FLAT HEAD,REC	Service Item	1	\$	2.90
36684-047	RING-RETAINING EXTERNAL HD	Service Item	1	\$	4.80
36701-01	POPPET, SAFETY	Service Item	1	\$	2.60
36705-01	RETAINER PACKING BACKUP		1	\$	2.90
36711-00	PACKING, PREFORMED, BUNA-N		1	\$	3.10
36713-00	VALVE PLUG & SEAT ASSY *KB*	Service Item	1	\$	10.80
36715-00	BODY,SAFETY** *KB*		1	\$	14.70
36744-02	PACKING, PREFORMED		1	\$	3.80
36750-01	COVER, PRESSURE GAUGE		1	\$	4.30
36751-01	SPRING, WAVE WASHER		1	\$	2.80
36752-01	SPRING, HANDWHEEL		1	\$	3.60
36755-02	HANDWHEEL ASSEMBLY		1	\$	18.20
36765-01	LENS, PRESSURE GAUGE		1	\$	4.90
36814-00	PACKING, WASHER		1	\$	3.30
36862-02	PACKING,PREFORM .492ID X .039W		1	\$	5.15
36862-06	PACKING,PREFORM .256ID X .047W		1	\$	3.60
36862-10	PACKING,PREFORMED		1	\$	13.15
36862-11	PACKING,PREFORM .250ID X .035W		1	\$	4.40
36862-13	PACKING,PREFORMED		1	\$	8.75
37058-01	SOCKET		1	\$	3.00
37059-01	DRIVER		1	\$	35.40
37061-01	WASHER, FLAT		1	\$	3.10
37079-01	PACKING PERFORMED		1	\$	3.10
37082-01	PACKING PERFORMED		1	\$	3.10
37084-01	WASHER,SAFETY CAP		1	\$	3.00
37090-02	WASHER, WEAR		1	\$	3.60
37091-02	WASHER, PACKING**		1	\$	3.30
37092-02	BONNET		1	\$	20.50
37093-02	STEM, VALVE -KB-		1	\$	17.00
40000035	2.5%NATURAL GAS CYLINDER(HM)		1	\$	48.00
40000056	O RING D-LINE INLET/OUTLET FTG		1	\$	1.60
40000211	CELL BLOCK FLAME ARRESTOR		1	\$	3.20
40002800	S.S.PIPE PLUG		1	\$	5.00
40002938	SCREW #6-32 X 3/8 PAN HEAD		1	\$	3.20
40008244	PASE #10 LOCK WASHER		1	\$	1.20
40008583	BULB,ASPIRATOR		1	\$	10.00
40008654	ASPIRATOR BULB ASSY.		1	\$	6.30
40009207	AN ADAPTER, BRASS		1	\$	7.50
40012165	EI, SPLIT-LOCK WASHER (10)		1	\$	0.05
40012648	JUMPER,MINIATURE		1	\$	2.15
40013885	SENSOR REPLACEMENT- CO		1	\$	270.00
40013975	ALKALINE "AA" BATTERY		4	\$	2.25
40014092	REPLACEMENT N1-CAD BATTERY PK		1	\$	126.00
40014439	EI PISTOL GRIP ASSEMBLY		1	\$	110.83
40014444	EI, BALL BEARING (10)		1	\$	5.30
40014447	EI, DETENT SPRING (10)		1	\$	5.30
40014453	EI, NECK STRAP ASSY.		1	\$	54.00
40014585	EI, HANDSTRAP PAD		1	\$	17.00
40014588	EI, SWIVEL STUD		1	\$	4.20
40014606	EI,SCREW,FLAT HD,TYPE PT,3X8MM		1	\$	2.10
40014635	EI,CABLE,2.5MM TO CIGARET PLUG		1	\$	32.00
40014658	O-RING, SILICONE, LENS ASS'Y		1	\$	3.20
40014667	EI, 2 CHANNEL VIDEO RECEIVER		1	\$	1,551.00
40014777	AAA BATTERY, ALKALINE		1	\$	2.10
40014806	REPLACEMENT CO500 SENSOR ASSY.		1	\$	218.00
40014825	EI, TRIPOD		1	\$	100.00
40014827	EI, 12 FT. LONG CIGARETTE CORD		1	\$	56.00
40014828	EI, VIDEO CABLE ASSY		1	\$	46.00
40014832	EAGLE IMAGER RECEIVER FOR WRLS		1	\$	2,173.00
40014839	EI INTERFACE BOARD ASY W/VIDEO		1	\$	292.00
40014973	EI MOBILE ANT.ASSY.2.4GHZ OMNI		1	\$	310.00



40014980	EI MOBILE VIDEO RECEIVER ASSY		1	\$	2,054.00
40015093	EI TCS, MOUNTING KIT		1	\$	30.00
40015098	MOTION SENSOR KIT, SE/SE+		1	\$	136.90
40015100	SENSOR MODULE GASKET KIT		1	\$	32.40
40015101	WIRE SHEATH KIT, SE & SE+		1	\$	213.18
40015103	CONSOLE HS REPLAC ASSY,SE/SE60		1	\$	231.99
40015105	REPLAC CONSOLE BOARD ASSY,SE		1	\$	116.00
40015183	REPLACEMENT CO1000 SENSOR ASSY		1	\$	218.00
40389-00	SOCKET & HOSE CLAMP ASSEMBLY		1	\$	120.00
50004-15	SEALING COMPOUND "222"		1	\$	18.85
50004-16	SEALING COMPOUND 242		1	\$	62.18
50004-18	SEALING COMPOUND "271"		1	\$	29.10
50004-20	SEALING COMPOUND		1	\$	86.91
50011-00	TAPE,ANTISEIZE 1/4"		1	\$	20.80
50521-00	KRYTOX		1	\$	1,610.00
50576-02	LOCTITE 422 INSTANT ADHESIVE		1	\$	84.20
50721-02	SEALING COMPOUND		1	\$	21.67
50721-03	SEALING COMPOUND		1	\$	81.10
50728-01	RHEOLUBE 719M**	Service Item	1	\$	46.80
50729-01	LUBRICANT, SILICONE	Service Item	1	\$	137.30
50756-01	LOCTITE, BLACK MAX 380		1	\$	97.80
50757-02	LOCTITE, X-NMS, CLEAN-UP SOLV		1	\$	64.23
50758-01	LUBRICANT		1	\$	535.60
50785-01	SCREW		1	\$	2.40
50785-02	PASE MOTION SNSR ASY SCREW(10)		1	\$	3.30
50786-01	RING, I.D. BUTTON (YELLOW)		1	\$	12.50
50786-02	RING, I.D. BUTTON (RED)		1	\$	12.54
50786-03	RING, ID BUTTON (BLUE)		1	\$	12.54
50795-10	ADHESIVE, EPOXY, HYSOL E-05CL		1	\$	43.00
50835-02	PASE CNSL PC BRD ASY SCREW(10)		1	\$	1.20
50854-00	PACKING, PREFORMED (PA SE)		1	\$	2.80
50903	ADHESIVE, RTV 5900		1	\$	158.10
50904-08	CLAMP,LOOP-STEEL PLAIN		1	\$	4.50
50904-37	CLAMP,LOOP-STEEL,CUSHIONED		1	\$	5.40
50904-39	CLAMP,LOOP STEEL,CUSHIONED		1	\$	5.20
517.300.021	WALK TEST TOOL		1	\$	820.00
5500-7100	FLTR REFLS 10/PK, PLASTIC FOAM		1	\$	16.00
55065-00	SOCKET SUPPLY HOSE		1	\$	75.00
55622-00	PACKING, PREFORMED		1	\$	3.10
55810-00	PACKING,PREFORM .07W X .114ID		1	\$	3.30
56427-00	PACKING PREFORMED		1	\$	2.75
56756-00	PLUG, 1/4" FPT HANSEN		1	\$	9.90
56894-00	EYELET		1	\$	3.10
56940-00	PACKING, PREFORMED		1	\$	2.50
57120-05	RIVET,BLIND,DOMED HD,OPEN END		1	\$	2.30
57251-00	PACKING, PREFORMED		1	\$	2.40
57252-00	PACKING, PREFORMED		1	\$	2.40
57253-00	PACKING, PREFORMED		1	\$	2.40
57264-00	PACKING, PREFORMED		1	\$	5.20
57518-00	PIN, SPRING		1	\$	2.30
58298-00	VALVE,HIGH PRESS-PKD TYPE MS		1	\$	75.90
58353-00	PISTON		1	\$	74.90
58355-00	WASHER		1	\$	2.50
58370-01	REDUCER ASSEMBLY		1	\$	317.20
58651-00	PACKING, PREFORMED		1	\$	3.30
58652-00	PACKING, PREFORMED		1	\$	3.30
59274-00	PACKING, PREFORMED		1	\$	5.90
59275-00	PACKING, PREFORMED		1	\$	5.90
59276-00	RELIEF VALVE ASSY,(LOW PRESS.)		1	\$	87.40
59277-00	PACKING, PREFORMED		1	\$	5.40
59333-00	O RING		1	\$	6.00

595132-01	LIBERTY O&M		1	\$	25.00
59607-00	PACKING, PREFORMED		1	\$	2.30
600310-00	POUCH,GAS MASK-CHIN STYLE		1	\$	48.00
60158-00	ANTI-FOG PREPARATION		1	\$	14.20
6388-02	MANIFOLD, RESPIRATOR		1	\$	54.10
64152-02	VALVE ASSY		1	\$	13.50
64197-01	VALVE, CHECK		1	\$	3.40
6507-01	BUCKLE, SPRING ACTION		1	\$	7.20
6538-00	WALL CASE		1	\$	1,400.00
6811-00	VALVE-RELIEF		1	\$	214.20
6816-00	PLUG 1/4" MPT HANSEN		1	\$	11.50
6825-00	PLUG-COUPLING		1	\$	15.90
6831-00	SOCKET		1	\$	84.20
6835-00	SOCKET ASSY		1	\$	116.50
7420-108	ASSY, XCEL HALF HEAD HARNESS		1	\$	9.40
7421-111	XCEL SM GREY HALF MASK RESP		1	\$	32.00
7421-111V	XCEL SM GREY HALF MASK VM RESP		1	\$	39.00
7421-112	XCEL S/M GREY HALF MASK RESP		1	\$	32.00
7421-112V	XCEL SM GREY HALF MASK VM RESP		1	\$	39.00
7421-113	XCEL M/L GREY HALF MASK RESP		1	\$	32.00
7421-113V	XCEL ML GREY HALF MASK VM RESP		1	\$	39.00
7421-114	XCEL LG GREY HALF MASK RESP		1	\$	32.00
7421-114V	XCEL LG GREY HALF MASK VM RESP		1	\$	39.00
7421-411V	ASSY, XCEL HS SM HALF MASK VM		1	\$	39.00
7421-412V	ASSY, XCEL HS S/M HALF MASK VM		1	\$	39.00
7421-413V	ASSY, XCEL HS M/L HALF MASK VM		1	\$	39.00
7421-414V	ASSY, XCEL HS LG HALF MASK VM		1	\$	39.00
7421-511V	CASE, XCEL HS SM HALF MASK VM		1	\$	759.00
7421-512V	CASE, XCEL HS S/M HALF MASK VM		1	\$	759.00
7421-513V	CASE, XCEL HS M/L HALF MASK VM		1	\$	759.00
7421-514V	CASE, XCEL HS LG HALF MASK VM		1	\$	759.00
7421-PF1	XCEL SMALL PROBED FACE PIECE		1	\$	49.50
7421-PF2	XCEL S/M PROBED FACE PIECE		1	\$	49.50
7421-PF3	XCEL M/L PROBED FACE PIECE		1	\$	49.50
7421-PF4	XCEL LARGE PROBED FACE PIECE		1	\$	49.50
7422-BA1	OV,78CC, PAIR		1	\$	12.00
7422-BB1	OV-P100,78CC PAIR		1	\$	23.30
7422-BC1	OV,120CC, PAIR		1	\$	15.30
7422-BD1	OV-P100,120CC,PR		1	\$	26.80
7422-CD1	742 CSCN/P100,120CC CARTRIDGE		1	\$	29.70
7422-FC1	ENCLOSURE COVER, PAIR		1	\$	12.60
7422-FC4	ENCLOSURE COVER, 5 PR/BX		1	\$	60.00
7422-FE4	ENCLOSURE COV/RETAIN,5 PR/BX		1	\$	85.00
7422-FG4	GASKET/ENCLOSURE COV, 5 PR/BX		1	\$	115.00
7422-FN5	N-95 FILTER ELEMENT,50 PR/CASE		1	\$	147.00
7422-FP1	MINI P100 FILTER, PAIR		1	\$	10.00
7422-FP4	CARTON OF 80 PRS, 742 MINI		1	\$	800.00
7422-FT1	TEST FIT ADAPTER		1	\$	45.90
7422-GA1	AM,78CC, PAIR		1	\$	14.00
7422-GB1	AM-P100, 78CC CARTRIDGE PAIR		1	\$	25.60
7422-GC1	AM, 120CC, PAIR		1	\$	21.20
7422-GD1	AM-P100,120CC,PR		1	\$	33.40
7422-IA1	FORMALDEHYDE, 78CC, PAIR		1	\$	15.90
7422-IB1	FORMALDEHYDE-P100,78CC CART PR		1	\$	29.70
7422-PD1	TEDA-P100, 120CC, PAIR		1	\$	37.70
7422-SC1	MPC, 120CC, PAIR		1	\$	13.10
7422-SD1	MPC-P100, 120CC, PAIR		1	\$	24.90
7422-WA1	AG, 78CC, PAIR		1	\$	12.90
7422-WB1	AG-P100,78CC CARTRODGE PAIR		1	\$	24.60
7422-WC1	AG, 120CC, PAIR		1	\$	15.90
7422-WD1	AG-100, 120CC, PAIR		1	\$	28.00

7422-YC1	OA, 120CC, PAIR		1	\$	12.70
7422-YD1	OA-P100, 120CC, PAIR		1	\$	24.00
7422-ZA1	HGCL, 78CC CARTRIDGE PAIR		1	\$	25.00
7422-ZB1	HGCL-P100 78CC, CARTRIDGE PAIR		1	\$	36.90
8000001	LED SVC Kit-PZM		1	\$	45.00
8000002	SCREW/HDWR Kit- SVC PZM		1	\$	30.00
8000003	Tubing/Barb Kit, SVC PZM		1	\$	80.00
8000004	Cable Tie Kit, SVC PZM		1	\$	10.00
8000005	Cal Bottle Mount Kit, SVC PZM		1	\$	95.00
8000007	CCER KAPTON IN 2ND CONTAINER		1	\$	900.00
8000010	CCER 1ST CNTAIER-TRAINR-KAPTON		1	\$	1,015.00
8000011	CCER 2ND CONTAINER-NVY		1	\$	75.00
8000013	CCER KAPTON IN 1ST CONTAINER		1	\$	865.00
8000014	CCER 2ND CONTAINER TRAINER		1	\$	75.00
8000016	CCER KAPTON TRAINER		1	\$	1,050.00
8000-1100	FILAMENT, ACTIVE, RED, G		1	\$	94.00
800030-02	COUPLING NUT ASSY		1	\$	72.80
80006-02	WALKAWAY BRKT ASSY,2.2 AIR PAK		1	\$	387.90
80007-02	WALKAWAY BRKT ASSY,4.5 AIR-PAK		1	\$	387.90
80008-02	WALKAWAY BRACKET ASSY		1	\$	387.90
8000-8090	DETECTOR ELEMENT, TLV		1	\$	225.00
800103-00	HOSE ASSY, REGULATOR		1	\$	113.40
800198-00	COUPLING ASSY		1	\$	208.00
801935-03	(HM) AL.CYL&VLV 5 MIN.		1	\$	410.00
802162-01	CARRYING CASE		1	\$	477.40
802200-01	HARNESS ASSEMBLY		1	\$	180.00
802200-02	SHOULDER STRAP ASSY		1	\$	144.60
802210-01	PISTON ASSY, DEMAND VALVE	Service Item	1	\$	43.70
802220-02	PRESSURE REDUCER ASSY.(4.5)		1	\$	2,030.00
802220-03	PRESSURE REDUCER ASSY.(4.5)		1	\$	2,250.00
802221-02	PR OUTLET & RELIEF VALVE ASSY		1	\$	194.50
802223-01	COVER ASSY,PRESS REDUCER	Service Item	1	\$	321.40
802227-01	CAP,ASSY OF-AUTO ACTUATOR	Service Item	1	\$	20.50
802228-01	HOSE & COUPLING ASSY		1	\$	303.70
802228-02	HOSE & COUPLING ASSY		1	\$	303.70
802228-06	HOSE & COUPLING ASM		1	\$	294.30
802228-13	HOSE & COUPLING ASSY		1	\$	800.80
802228-14	HOSE & COUPLING ASSY		1	\$	903.80
802228-15	HOSE & COUPLING ASSY		1	\$	651.00
802228-16	HOSE & COUPLING ASSY		1	\$	800.00
802229-01	HOSE ASSY,HP		1	\$	182.00
802229-02	HOSE ASSEMBLY		1	\$	153.90
802229-03	HOSE ASSEMBLY,HIGH PRESSURE		1	\$	178.90
802276-01	PRESSURE REDUCER ASSY.(2.2)		1	\$	2,030.00
802276-03	PRESSURE REDUCER ASSY (2.2)		1	\$	2,250.00
802295-01	VALVE ASSY, CHECK	Service Item	1	\$	35.40
802295-02	VALVE ASSY, CHECK	Service Item	1	\$	35.40
802471-01	GASKET		1	\$	2.30
802837-01	TOOL KIT		1	\$	1,410.00
802864-01	VALVE ASSY,CHECK		1	\$	163.30
802865-01	ALARM ASSEMBLY	Service Item	1	\$	319.30
802870-01	FILTER INSTALLATION TOOL	Service Item	1	\$	582.40
802872-01	FILTER REMOVAL HAND TOOL		1	\$	201.80
802873-01	TUBE & RESTRICTOR ASSEMBLY	Service Item	1	\$	66.60
802919-01	REG.BODY SUB-ASSY.(SPARE PART)		1	\$	141.40
802929-02	SHAFT WRENCH	Service Item	1	\$	176.80
803144-01	DUAL PORT OUTLET MANIFOLD		1	\$	189.30
803144-02	OUTLET & MANIFOLD ASSEMBLY		1	\$	143.50
803191-01	DEMAND VALVE GUIDE		1	\$	24.90
803194-01	HOSE ASSEMBLY		1	\$	160.00
803194-02	EZ AIRLINE HOSE W/HANS FITTING		1	\$	140.00

803194-03	EZ AIRLINE HOSE W/SHR FITTING		1	\$	140.00
803194-05	HOSE ASSEMBLY		1	\$	190.00
803194-08	HOSE ASSY - 36"		1	\$	180.00
803278-01	CARRY CASE-A/S SKA		1	\$	190.00
803351-01	STEM ASSEMBLY, PURGE--	Service Item	1	\$	14.70
803380-01	VALVE BODY ASSY (2216PSI)		1	\$	173.70
803380-02	VALVE BODY ASSY.(4500PSI)		1	\$	173.70
803380-06	VALVE BODY ASSY,MACH 5500 PSI		1	\$	173.70
803380-07	VALVE BODY ASSY, 2216, NXG		1	\$	195.50
803380-08	VALVE BODY ASSY, 4500, NXG		1	\$	195.50
803380-09	VALVE BODY ASSY, 5500, NXG		1	\$	195.50
803392-01	GAGE,PRESS DUAL POINTER		1	\$	129.00
803393-01	GAGE,PRESS DUAL POINTER		1	\$	129.00
803454-01	WRENCH ASSEMBLY,CYLINDER VALVE		1	\$	337.00
803549-01	HEAD HARNESS		1	\$	16.00
803566-01	BODY AND CAP, ASSY OF *KB*		1	\$	141.40
803596-01	REGULATOR CAP ASSY		1	\$	49.90
803620-01	PASS-THRU ASSY, SUIT(HAN)**		1	\$	150.00
803620-02	PASS-THRU ASSY, SUIT (SCHR)**		1	\$	150.00
803620-03	PASS-THRU ASSY, SUIT (HNSN)		1	\$	360.00
803732-01	BUCKLE ASSY, HEAD HARNESS		1	\$	7.10
803759-01	VOICEMITTER ASSY *KB*		1	\$	19.00
803792-01	EZF DIAPHRAGM & VALVE ASSEMBLY		1	\$	124.80
803793-01	LEVER ASSY, REG, MAN SHUT-OFF		1	\$	7.50
803806-07	2.2/4.5 HIP PAD ASSY, BLACK		1	\$	209.00
803810-03	2.2/4.5 HIP&SHOULDER PAD,BLACK		1	\$	381.70
803810-04	ISCBA HIP & SHOULDER PAD KIT		1	\$	353.60
803834-01	90-AG MOUTHBIT RESP W/POUCH		1	\$	29.00
803834-02	R90-AG MOUTHBIT RESP, RPLMENT		1	\$	25.50
803834-03	C90-AG MOUTHBIT RESP W/CASE		1	\$	43.00
803834-30	90-AG,MOUTHBIT W/POUCH(BULK30)		1	\$	863.00
803834-32	C90-AG MOUTHBIT W/CASE(BULK30)		1	\$	1,283.00
803839-01	90-AM MOUTHBIT RESP W/POUCH		1	\$	29.00
803839-02	R90-AM MOUTHBIT RESP RPLMENT		1	\$	25.50
803839-03	C90-AM MOUTHBIT RESP W/CASE		1	\$	43.00
803839-30	90-AM MOUTHBIT W/POUCH(BULK30)		1	\$	863.00
803839-32	C90-AM MOUTHBIT W/CASE(BULK30)		1	\$	1,283.00
803920-01	BAND ASSY, NECK		1	\$	18.70
803920-02	BAND ASSY, NECK		1	\$	18.70
803928-01	FENESTRA, HARDCOATED		1	\$	57.00
803928-02	FENESTRA, HARDCOATED		1	\$	66.00
803930-02	FIT TEST KIT, 40MM ADAPTER		1	\$	97.00
803941-25	KIT,COVER,LENS,PROTECTIVE		1	\$	63.00
804010-01	VOICEMITTER ASSEMBLY *KB*		1	\$	14.50
804014-01	AV2 NOSECUP ASSEMBLY KIT		1	\$	110.00
804015-01	INHALATION VALVE ASSY		1	\$	8.25
804018-01	FENESTRA ASSEMBLY		1	\$	74.00
804018-04	FENESTRA ASSEMBLY		1	\$	60.00
804019-01	AV-2000 FACEPIECE ASSY.L/HH		1	\$	210.10
804019-02	AV-2000 FACEPIECE ASSY. L/HH		1	\$	210.10
804019-03	AV-2000 FACEPIECE ASSY.L/HH		1	\$	210.10
804019-08	MASK FACEPIECE ASSY W/NOSE CUP		1	\$	210.10
804039-01	FENESTRA ASSY		1	\$	188.30
804058-01	ADAPTER, CHIN CANISTER		1	\$	44.00
804059-01	2.2 GAUGE & LINE COMPLETE		1	\$	323.40
804059-02	4.5 GAUGE & LINE COMPLETE		1	\$	323.40
804059-03	3.0 GAUGE & LINE COMPLETE		1	\$	216.30
804059-04	2.2 GAUGE & LINE COMPLETE		1	\$	218.40
804059-05	4.5 GAUGE & LINE COMPLETE		1	\$	218.40
804059-06	3.0 GAUGE & LINE COMPLETE		1	\$	220.00
804059-14	2216 GAUGE W/GAUGE LINE		1	\$	311.00

804059-15	4500 GAUGE W/GAUGE LINE		1	\$	311.00
804059-16	5500 GAUGE W/GAUGE LINE		1	\$	311.00
804061-01	BAND ASSY, CAP-POLYESTER		1	\$	19.00
804063-01	HEAD HARNESS ASSY.POLYESTER		1	\$	78.00
804069-19	AV2 W/POLY HARN, GRAY NC(SM)		1	\$	235.00
804069-20	AV2 W/POLY HARN, GRAY NC(LG)		1	\$	235.00
804069-21	AV2 W/POLY HARN, GRAY NC(XLG)		1	\$	235.00
804069-28	AV2 W/POLY HARN, GRAY NC(CS)		1	\$	235.00
804082-01	KEEPER, STRAP 1 IN YELLOW		1	\$	29.10
804083-01	SIDE STRAP, KEVLAR 1"		1	\$	31.20
804084-03	STRAP ASSY, SHOULDER(NYLON)		1	\$	155.00
804084-04	2.2/4.5 SHOULDER STRAP, BLK KEV		1	\$	158.10
804084-05	STRAP ASSEMBLY, SHOULDER BLKEV		1	\$	145.60
804085-01	STRAP ASSEMBLY, WAIST		1	\$	35.40
804085-02	CONNECTOR STRAP ASSY WAIST		1	\$	69.70
804085-03	BUCKLE STRAP ASSY, WAIST		1	\$	75.90
804085-07	WAIST STRAP/BLK KEV/WIREFRM AP		1	\$	31.20
804085-08	2.2/4.5 WAIST STRAP W/CNCTR BL		1	\$	66.60
804085-09	2.2/4.5 WAIST STRP W/BKL BLK K		1	\$	72.80
804086-01	STAY ASSEMBLY, WAIST/FRAME		1	\$	36.40
804086-03	ISCB, STAY ASSEMBLY, WAIST/FRAME		1	\$	37.40
804088-01	STRAP ASSY., NECK (KEVLAR)		1	\$	38.50
804088-02	STRAP ASSY., NECK		1	\$	38.50
804091-01	KIT, GAUGE PROTECTOR		1	\$	48.90
804094-01	TUBING ASSY., GAUGE LINE		1	\$	296.40
804094-03	GAUGE LINE TUBING ASSY, CRICKET		1	\$	280.80
804094-04	SWAT GAUGE LINE		1	\$	332.80
804094-05	GAUGELINE, AT, SHORT		1	\$	175.00
804094-06	GAUGELINE, AT, MEDIUM		1	\$	172.60
804094-07	GAUGELINE, AT, LONG		1	\$	169.50
804096-01	SAMPLING PROBE ASSEMBLY		1	\$	18.60
804097-01	VALVE ASSY., CYLINDER 2.2/IIA		1	\$	413.90
804097-02	VALVE ASSY, CYLINDER 3.0		1	\$	413.90
804098-01	VALVE ASSY, CYLINDER 4.5		1	\$	413.90
804098-02	VALVE ASSY, CYLINDER		1	\$	413.90
804101-01	AL.CYL&VLV ASSY.		1	\$	630.00
804101-01-D	AL.CYL. & VALVE ASSY.		1	\$	630.00
804110-01	E-Z FLO REGULATOR COVER		1	\$	84.20
804110-03	COVER ASSY, REG MANUAL SHUT OFF		1	\$	107.10
804110-13	COVER ASSY, REG, 13, CBRN		1	\$	103.00
804111-03	BAND ASSEMBLY, CYLINDER		1	\$	140.40
804113-01	BUMPER AND GUARD ASSY *KB*		1	\$	26.10
804172-01	BACK FRAME ASSY.2.2/4.5		1	\$	469.00
804172-02	BACK FRAME ASSY		1	\$	451.00
804172-05	BACK FRAME ASSY		1	\$	1,270.00
804172-06	BACK FRAME ASSEMBLY		1	\$	467.00
804172-07	WF BACK FRAME ASSY L/BLKHARNES		1	\$	450.30
804172-08	BACK FRAME ASSEMBLY		1	\$	1,223.00
804172-09	BACK FRAME ASSEMBLY		1	\$	1,223.00
804173-01	BACK-PAK ASSY.2.2/4.5		1	\$	1,320.00
804173-02	2.2/4.5 WR BCKFRM W/MTL BAND		1	\$	2,440.00
804173-03	WIRFRAME & HARNBACK-PAK ASSY		1	\$	836.20
804173-11	BACK-PAK ASSY		1	\$	1,270.00
804173-12	BACK-PAK ASSY		1	\$	2,440.00
804173-13	BACK-PAK ASSY		1	\$	834.10
804173-25	BACK-PAK ASSY, AP75, SS, WF		1	\$	2,272.00
804176-01	BAND ASSY., NECK (KEVLAR)		1	\$	23.90
804176-02	BAND ASSY, NECK		1	\$	23.90
804177-01	HEAD HARNESS ASSY.KEVLAR		1	\$	175.00
804178-01	TEMPLE STRAP ASSY.- KEVLAR		1	\$	23.90
804178-02	HEANET ASSY, KEVLAR		1	\$	22.80

804191-01	MASK ASSY, AV-2000 KEV SML		1	\$	314.00
804191-02	MASK ASSY, AV-2000 KEV STD		1	\$	314.00
804191-03	MASK ASSY, AV-2000 KEV XL		1	\$	314.00
804191-08	AV2000 W/KEV HARN COMF. SEAL(S)		1	\$	314.00
804191-71	AV2000,KEV,SM,RUB,07NC		1	\$	314.00
804191-72	AV2000,KEV,L,RUB,07NC		1	\$	314.00
804191-73	AV2000,LEV,XL,RUB,07NC		1	\$	314.00
804191-74	AV2000,KEV,CS,RUB,07NC		1	\$	314.00
804191-75	AV2000,KEV,SM,RUB,07NC,W/CLP		1	\$	340.00
804191-76	AV2000,KEV,L,RUB,07NC,W/CLP		1	\$	340.00
804191-77	AV2000,KEV,XL,RUB,07NC,W/CLP		1	\$	340.00
804191-78	AV2000,KEV,CS,RUB,07NC,W/CLP		1	\$	340.00
804192-01	CASE, CARRYING-MOUTHBIT C-90		1	\$	21.00
804194-01	COVER ASSEMBLY, BUTTON		1	\$	38.67
804221-01	REGULATOR ASSY		1	\$	711.40
804223-01	COVER,SKA-PAK E-Z FLO REG.		1	\$	88.00
804281-01	(HM) CYL&VLV 4500 PSI		1	\$	610.00
804298-01	BODY & CHECK VALVE ASSY		1	\$	110.00
804304-01	PRESS REDUCER ASSY 4.5		1	\$	404.60
804304-11	PRESSURE REDUCER 2.2/3.0		1	\$	404.60
804305-01	HOSE ASSY, AIRLINE CONNECTION		1	\$	110.00
804305-02	HOSE ASSY, AIRLINE CONNECTION		1	\$	110.00
804305-03	SKAPAK AL HOSE W/HANSEN HK FTG		1	\$	200.00
804305-04	AIRLINE HOSE, HAN PLUG W/FASTN		1	\$	150.00
804305-05	AIRLINE HOSE,SCH PLUG W/FASTNR		1	\$	150.00
804305-06	AIRLINE HOSE, HK PLUG Q/FASTN		1	\$	210.00
804305-07	AIRLINE HOSE, CEJN PLUG		1	\$	190.00
804305-09	AIRLINE HOSE, HANSEN SOCKET		1	\$	200.00
804305-10	AIRLINE HOSE, HANSEN W/FASTENR		1	\$	240.00
804307-01	HARNESS ASSY, KEVLAR		1	\$	400.00
804310-01	PRESS REDUCER ASSY 4.5		1	\$	298.50
804310-02	REDUCER, PRESSURE ASSEMBLY		1	\$	690.00
804310-11	PRESSURE REDUCER 2.2/3.0		1	\$	300.00
804315-02	PASE MOTION SENSOR ASSY		1	\$	93.01
804319-01	HOSE ASSY, DUAL AIR SUPPLY **	Service Item	1	\$	450.00
804319-02	HOSE ASSY, DUAL AIR SUPPLY **	Service Item	1	\$	450.00
804334-01	VALVE ASSY, TRANSFER (4.5)	Service Item	1	\$	37.40
804334-02	VALVE ASSY, TRANSFER (2.2)	Service Item	1	\$	36.40
804334-03	VALVE ASSEMBLY TRANSFER	Service Item	1	\$	38.50
804335-04	HOSE & SOCKET ASSY PERFECTING		1	\$	318.20
804335-10	HOSE & SOCKET ASSEMBLY		1	\$	449.30
804335-11	HOSE & SOCKET ASSEMBLY		1	\$	81.10
804335-14	HOSE & SOCKET ASSEMBLY		1	\$	318.20
804336-01	REGULATOR, HOSE ASSY	Service Item	1	\$	183.00
804336-11	HOSE ASSY, REGULATOR, AP75i		1	\$	172.00
804337-01	HOSE, PLUG ASSY.		1	\$	172.60
804370-01	REG ASSY, E-Z FLO STD HOSE		1	\$	900.60
804370-02	REG ASSY, E-Z FLO Q.D. HOSE		1	\$	923.50
804370-05	REG ASSY, SWAT Q.D. HOSE M.S.O		1	\$	923.50
804370-09	REG ASSY, SKA-PAK A/T M.S.O.		1	\$	890.00
804370-10	REG ASSY, HUD W/Q.D. HOSE MSO		1	\$	1,330.00
804370-11	REG ASSY, HUD STD HOSE M.S.O.		1	\$	1,330.00
804381-03	BOTTOM ENCLOSURE ASSEMBLY		1	\$	102.41
804386-19	E-Z AIRLINE, AV2 POLY HANSEN		1	\$	800.00
804386-25	E-Z AIRLINE, AV2 POLY, SCHRADR		1	\$	800.00
804386-31	E-Z AIRLINE, AV2 POLY, HK		1	\$	880.00
804386-62	E-Z AIRLINE, LESS FP, SCHRADER		1	\$	560.00
804386-66	E-Z AIRLINE, LESS FP, HANSEN		1	\$	560.00
804386-67	E-Z AIRLINE, LESS FP, HANSEN LH		1	\$	560.00
804415-01	A/P 50 BACKFRAME/HARNESS ASS'Y		1	\$	1,290.00
804415-02	AP50 BACKFRAME & HARNESS ASSY		1	\$	1,290.00

804421-01	CYLINDER RETENTION ASSY		1	\$	145.00
804422-01	CYL RETENTION ASSY/WIRE FRAME		1	\$	70.70
804422-02	CYL RETENTION ASSY (WIRE FRAME		1	\$	53.00
804422-03	CYL RETENTION ASSY (WIRE FRAME		1	\$	55.10
804422-04	CYLINDER RETENTION ASSEMBLY		1	\$	95.70
804423-01	AP50 CYLINDER LATCH ASSEMBLY		1	\$	45.00
804424-01	CYL STRAP ASSY (WIRE FRAME)		1	\$	80.10
804424-02	CYL STRAP ASSY (WIRE FRAME)		1	\$	33.30
804424-04	CYLINDER STRAP ASSY -WIREFRAME		1	\$	75.90
804425-01	CYLINDER STRAP ASSY		1	\$	64.50
804425-02	CYL STRAP ASSY,(PLATE FRAME)		1	\$	64.50
804425-04	CYLINDER STRAP ASSY, AP75 WF		1	\$	50.00
804426-01	WAIST BELT ASSY(FEMALE BUCKLE)		1	\$	66.60
804427-01	WAIST BELT ASSY (MALE CONN.)		1	\$	62.40
804428-01	SHOULDER PAD ASSY (PLATE FRAME		1	\$	366.10
804428-02	SHLDR PAD W/SPR BUCK, AP50		1	\$	363.00
804441-01	EZ AIRLINE REG, HANSEN		1	\$	470.00
804441-02	EZ AIRLINE REG, SCHRADER		1	\$	470.00
804441-03	EZ AIRLINE REG, HANSEN HK		1	\$	550.00
804441-04	E-Z FLO REG. ISCBA		1	\$	499.20
804441-05	E-Z FLO REG W/ MODULAIR		1	\$	514.80
804441-06	E-Z FLO REG ACS		1	\$	500.00
804442-01	KIT, EYEGLASS		1	\$	60.40
804453-07	ASSEMBLY, SHOULDER PAD (NFS)		1	\$	97.80
804453-08	PAD ASSEMBLY, SHOULDER		1	\$	90.00
804471-01	WAIST PAD ASSEMBLY		1	\$	293.30
804471-02	WAIST PAD, SPRING BUCKLE		1	\$	267.30
804474-01	GAUGE DUAL POINTER 310 BAR		1	\$	123.80
804475-01	COVER ASSY,E-Z AIRLINE REG.		1	\$	94.00
804475-02	REG CVR ASY MANUAL SHUT-OFF		1	\$	93.60
804476-01	SIDE STRAP, KEVLAR 1.5"(YL WF)		1	\$	37.40
804476-02	STRAP ASSY, SIDE		1	\$	15.00
804476-03	SIDE STRAP,BLKEV,WF		1	\$	56.20
804481-01	BELT, WAIST TO SHOULDER ASSY		1	\$	135.20
804493-01	HARNESS ASSEMBLY, BODY		1	\$	150.00
804497-01	CARRYING-CASE, HARD		1	\$	322.40
804497-02	CARRYING-CASE, HARD		1	\$	373.40
804499-01	BACKFRAME ASSEMBLY		1	\$	438.90
804512-01	BACK-PAK KIT		1	\$	1,380.00
804518-02	3.0 PRES REDUC W/O AL MANIFOLD		1	\$	1,970.00
804518-03	3.0 PRES REDUC W/AL MANIFOLD		1	\$	2,180.00
804519-01	QUICK CHARGE ASSY 2.2		1	\$	907.90
804519-02	QUICK CHARGE ASSY 3.0		1	\$	907.90
804519-03	QUICK CHARGE ASSY 4.5		1	\$	907.90
804530-01	STRAP ASSY, FASTENER		1	\$	43.70
804530-03	STRAP ASSEMBLY, FASTENER		1	\$	42.60
804538-01	3.0 V-A PRES DUAL POINTER GAGE		1	\$	48.90
804558-01	CAP ASSEMBLY (SCHRADER)		1	\$	235.00
804559-01	PASS RETAINER ASSEMBLY		1	\$	20.90
804564-01	VOICE AMPLIFIER		1	\$	575.80
804564-02	VOICE AMPLIFIER ASSY W/LT		1	\$	588.34
804575-01	2.2/4.5/3.0 QKCHG COUPLING ASY		1	\$	61.40
804594-01	MASK HOOK ASSEMBLY		1	\$	20.50
804595-01	CHARGING WAND ASSEMBLY 2.2		1	\$	1,230.00
804595-02	CHARGING WAND ASSY 3.0		1	\$	1,230.00
804595-03	CHARGING WAND ASSY 4.5		1	\$	1,230.00
804606-01	CAP ASSY(HANSEN)PN27537-05		1	\$	92.60
804619-01	ISCBA 2.2 PRESSURE REDUCER SP		1	\$	970.00
804619-02	ISCBA 2.2 PRES REDUCER W/DUAL		1	\$	1,070.00
804619-03	IND 2.2 PRESSURE REDUCER ASSY		1	\$	1,060.00
804621-02	ISCBA BKPK ASY KEV W/MTL BKL		1	\$	740.00

804621-03	ISCBA BKPK ASY NYL W/POLY BKL		1	\$	620.00
804622-05	MALE STRAP ASSY BUCKLE		1	\$	15.60
804622-06	FEMALE STRAP ASSY BUCKLE		1	\$	17.00
804636-01	BRACKET, MOUNTING ASSEMBLY		1	\$	53.30
804642-01	IND 4.5 REDUCER		1	\$	1,050.00
804642-02	IND 4.5 REDUCER DUAL		1	\$	1,160.00
804642-03	PRESSURE REDUCER, 4500 ASSY		1	\$	1,100.00
804642-04	IND 4.5 PRESSURE REDUCER ASSY		1	\$	1,060.00
804651-01	ALARM SUBASY,IND 2.2/4.5 RDR**		1	\$	168.50
804678-01	HOSE & SOCKET ASSY		1	\$	160.00
804679-01	HOSE,PLUG ASSY NON-VIBR(EZAL)**		1	\$	113.40
804694-01	HOSE AY MA, SKA+,EZA,INDL CJN		1	\$	200.00
804694-02	HOSE ASSY, HANSEN HK		1	\$	260.00
804694-03	HOSE ASSY, QUICK CONNECT		1	\$	150.00
804694-04	HOSE ASY,QK CONNECT(EZAL)		1	\$	160.00
804694-05	HOSE ASSY, QD,PERFECT. COUPLNG		1	\$	190.00
804706-03	PASE BATTERY COVER ASSY.		1	\$	21.95
804706-04	COVER ASSEMBLY BATTERY, SE+		1	\$	21.95
804706-06	COVER ASSEMBLY BATTERY SE		1	\$	23.80
804707-01	COVER ASSY REG MANUAL SHUT-OFF		1	\$	80.00
804721-01	CYL&VLV ASSY CARB,30MIN,4500		1	\$	1,000.00
804721-01-1	CYL&VALV ASSY CARB,30MIN,4500		1	\$	1,000.00
804721-01-D	CYL&VALV ASSY CARB,30MIN,4500		1	\$	1,000.00
804721-11	CYL&VALV ASSY CARB,30MIN,4500		1	\$	1,100.00
804721-11-D	CYL&VALV ASSY CARB,30MIN,4500		1	\$	1,000.00
804721-21-S	CYL&VALV ASSY CARB,30MIN,4500		1	\$	1,000.00
804721-31	CYL&VLV ASSY, C,30M,4.5		1	\$	1,385.00
804721-31-S	CYL&VLV W/SLV,C,30M,4.5		1	\$	1,560.00
804722-01	CYL&VLV ASSY,CARB,45MIN,4500		1	\$	1,370.00
804722-01-1	CYL&VALV ASSY CARB,45MIN,4500		1	\$	1,370.00
804722-01A	45MNCYL&VLVE ASY,CAR4500PSI SH		1	\$	1,370.00
804722-01A-1	CYL&VALV ASSY CARB,45MIN,4500		1	\$	1,370.00
804722-01-D	CYL&VALV ASSY CARB,45MIN,4500		1	\$	1,370.00
804722-11	CYL&VALV ASSY CARB,45MIN,4500		1	\$	1,460.00
804722-11-D	CYL&VALV ASSY CARB,45MIN,4500		1	\$	1,370.00
804722-21-S	CYL&VALV ASSY CARB,45MIN,4500		1	\$	1,370.00
804722-31	CYL&VLV ASSY, C,45M,4.5		1	\$	1,645.00
804722-31-S	CYL&VLV W/SLV,C,45M,4.5		1	\$	1,785.00
804723-01	(HM) CYL&VLV CARBON 60		1	\$	1,530.00
804723-01-1	CYL&VALV ASSY CARB,60MIN,4500		1	\$	1,530.00
804723-01-D	CYL&VALV ASSY CARB,60MIN,4500		1	\$	1,530.00
804723-11	CYL&VALV ASSY CARB,60MIN,4500		1	\$	1,610.00
804723-11-D	CYL&VALV ASSY CARB,60MIN,4500		1	\$	1,530.00
804723-31	CYL&VALV ASSY CARB,60MIN,4500		1	\$	2,100.00
804723-31-S	CYL&VALV ASSY CARB,60MIN,4500		1	\$	2,350.00
804825-01	FITTING ASY, TS 2.2/4.5**		1	\$	49.90
804827-01	TALK-AROUND MASK MOUNTED RADIO		1	\$	1,216.38
804840-01	CYL&VLV ASSY CARB,30MIN,2216		1	\$	1,120.00
804840-01-1	CYL&VALV ASSY CARB,30MIN,2216		1	\$	1,120.00
804840-01-D	CYL&VALV ASSY CARB,30MIN,2216		1	\$	1,120.00
804851-01	GAUGE ASSY. REMOTE MTG.		1	\$	331.80
804861-2807	NAVSEA,CBRN,4.5 AIR-PAK		1	\$	6,270.00
804861-2810	NAVSEA,CBRN,4.5 AIR-PAK		1	\$	6,235.00
804861-3702	AP WF 4.5,02 COMPL 30MIN CARB		1	\$	6,840.00
804861-3707	NAVSEA,CBRN,4.5 AIR-PAK		1	\$	7,340.00
804861-3710	NAVSEA,CBRN,4.5 AIR-PAK		1	\$	7,490.00
804861-38	AP4.5,45M,CARB,CRKT,AV2REV		1	\$	7,720.00
804861-3802	AP WF 4.5,02 COMPL 45 MIN CARB		1	\$	7,210.00
804861-3807	NAVSEA,CBRN,4.5 AIR-PAK		1	\$	7,720.00
804861-3810	NAVSEA,CBRN,4.5 AIR-PAK		1	\$	7,730.00
804861-50	AIR-PAK JAPANESE NAVY		1	\$	4,350.00



804862-01	GAUGE BLOCK ASSEMBLY		1	\$	62.40
804867-01	CLIP ASSY NAVSEA-RIGHT		1	\$	11.50
804867-02	CLIP ASSY NAVSEA-LEFT		1	\$	11.50
804868-01	FENESTRA ASSY W/ SNAPS		1	\$	155.00
804869-01	BEZEL ASSY NAVSEA		1	\$	24.00
804870-01	AV2000 LENS, L/HH W/SNAPS		1	\$	242.00
804870-02	AV2 L/HEAD HARNESS W/SNAPS		1	\$	242.00
804871-01	MASK ASSY AV2000 4 STRAP		1	\$	287.00
804871-02	MASK ASSY AV2000 4 STRAP		1	\$	287.00
804871-03	MASK ASSY AV2000 4 STRAP		1	\$	287.00
804871-31	AV2 W/RUBBER,SNAPS&EX VALVE(S)		1	\$	294.00
804871-32	AV2 W/RUBBER,SNAPS&EX VALVE(L)		1	\$	294.00
804871-33	AV2 W/RUBBER,SNAPS&EX VALVE(X)		1	\$	294.00
804872-01	BAND ASSY, CYLINDER		1	\$	332.80
804880-01	LED ALERT ASSEMBLY		1	\$	157.00
804886-01	VOICE AMP BATTERY COVER		1	\$	45.98
804911-01	CARRI-AIR PORT AIR SUPPLY-HAN		1	\$	690.00
804911-02	CARRI-AIR PORT AIR SUPPLY-SCHR		1	\$	690.00
804911-04	CARRI-AIR ASSEMBLY		1	\$	1,230.00
804911-05	CARRI-AIR ASSEMBLY		1	\$	1,240.00
804911-06	CARRI-AIR ASSEMBLY		1	\$	1,240.00
804946-01	HARNESS, CARRIAIR BACKFRAME &		1	\$	430.00
804946-02	HARNESS ASSEMBLY,CARRI-AIR		1	\$	550.00
804947-02	REDUCER, CARRIAIR ASSEMBLY (S)		1	\$	410.00
804961-01	SKAPAK 3.0,15MIN.CYL&VLV ASSY		1	\$	520.00
804961-02	C&V,3.0,15,EZ-CLIP		1	\$	520.00
804965-01	WIRE BAIL/FRAME ASSEMBLY NY		1	\$	164.30
804981-01	KEVLAR HARNESS ASSEMBLY		1	\$	420.00
804982-01	NYLON HARNESS ASSY SKA+(BLK)		1	\$	240.00
804985-01	HANGER BRACKET ASSEMBLY		1	\$	45.00
805004-03	CHARGING WAND ASSY., NAVSEA		1	\$	955.80
805031-01	SKAPK+ 2.2 5MN CYL&VLV ASSY		1	\$	450.00
805032-01	SKPK+ 10MN 4.5 CYL&VLV ASSY		1	\$	660.00
805044-01	CYL&VLV ASSY CARB,30MIN,3000		1	\$	1,300.00
805044-01-D	CYL&VALV ASSY CARB,30MIN,3000		1	\$	1,300.00
805059-01	40MM CANISTER ADAPTER		1	\$	43.70
805061-02	HARNESS ASSY,FALL PROT. SMALL		1	\$	700.00
805061-03	HARNESS ASSY,FALL PROT. LARGE		1	\$	700.00
805061-04	HARNESS ASSY,FALL PROT. MEDIUM		1	\$	700.00
805085-01	KEEPER, STRAP ASSEMBLY		1	\$	23.80
805088-01	AP 50 WAIST BELT EXTENSION		1	\$	31.20
805088-02	WAIST BELT 2"EXT NYL/PLY BKL		1	\$	29.10
805090-01	4.5 CRICKET ALERT		1	\$	493.00
805090-03	4.5 CRICKET ALERT Q/C O-PLUG		1	\$	493.00
805090-07	2.2 CRICKET ALARM		1	\$	493.00
805107-01	ASSEMBLY, CONSPACE LINK		1	\$	556.99
805119-01	HOUSING&FILTER ASSY,GAUGE BELL		1	\$	115.40
805121-01	POSI-CHEK3 INTERFACE KIT(H&G)*		1	\$	287.00
805121-02	INTERFACE KIT,POSI-CK 3,MIDRAN		1	\$	287.00
805123-01	INTERFACE HOSE LESS GAUGE		1	\$	54.10
805133-02	LED ALARM AND HOSE (QD) ASSY		1	\$	302.60
805177-01	PASS, PRESSURE SWITCH ASSY		1	\$	258.12
805182-02	WOV LENS HOLDER ASSY (FLIP UP)		1	\$	54.60
805185-01	SKA-PAK+RETRO KIT(5&10) N HRN		1	\$	180.00
805185-02	SKA-PAK+ RETROFIT KIT(5&10)KHN		1	\$	310.00
805191-03	CONSOLE ASSY,PASS ASSEMBLY		1	\$	287.38
805194-01	WELD-O-VISTA,L/HH,EPDM SEAL(S)		1	\$	282.00
805194-02	WELD-O-VISTA,L/HH,EPDM SEAL(L)		1	\$	282.00
805194-03	WELD-O-VISTA,L/HH,EPDM SEAL,XL		1	\$	282.00
805194-08	WELD-O-VISTA,L/HH,EPDM SEAL,CS		1	\$	282.00
805205-01	PASS WIRE SHEATH ASSY.		1	\$	147.35

805205-02	CABLE ASSY, 28.00" LONG		1	\$	180.00
805212-01	HANDLE BRACKET ASSY., CA/RIT		1	\$	64.50
805257-19	AV2 4PT RBR HARN,GRAY NC, SM		1	\$	235.00
805257-20	AV2 4PT RBR HARN,GRAY NC, MD		1	\$	235.00
805257-21	AV2 4PT RBR HARN,GRAY NC, LG		1	\$	235.00
805257-28	AV2 4PT RBR HARN,GRAY NC, CS		1	\$	235.00
805259-01	4-POINT RUBBER HEAD HARNESS		1	\$	66.00
805289-02	ATTACH-A-HOOD W/INSTALL KIT,BN		1	\$	165.00
805289-03	WELDO-O-VISTA HOOD INSTALL KIT		1	\$	196.00
805289-04	AV-NBC SHROUD W/INSTALL KIT		1	\$	330.00
805290-01	P.R. AUTO TRANSFER VALVE KIT		1	\$	79.00
805291-01	P.R. AUTO TRANSFER SEAL KIT		1	\$	12.50
805292-01	LOW CYL TRANSFR VALV KIT,4.5**	Service Item	1	\$	34.30
805293-01	LOW CYL TRANSFR VALV KIT,2.2**	Service Item	1	\$	34.30
805294-01	TRANSFER VALVE SEAL KIT, 4.5		1	\$	14.70
805295-01	TRANSFER VALVE SEAL KIT, 2.2		1	\$	14.70
805296-01	CHECK VALVE & SEAL KIT		1	\$	40.60
805297-01	AV2 HEAD HARNESS KIT		1	\$	191.00
805298-01	AV2 HEAD HARNESS STRAP KIT		1	\$	55.00
805299-01	AV2 LENS FRAME KIT		1	\$	37.50
805300-01	AV2 FACE SEAL KIT, (S)		1	\$	61.00
805301-01	AV2 FACE SEAL KIT,(L) BLACK		1	\$	61.00
805302-01	AV2 FACE SEAL KIT,(XL) RED		1	\$	61.00
805303-01	AV-2000 LENS KIT		1	\$	93.00
805304-01	AV2 VOICEMITTER KIT		1	\$	41.00
805307-01	AV2/SOV FACESEAL KIT(CS)		1	\$	61.00
805309-01	P.R. SEAT RETAINER KIT**	Service Item	1	\$	74.90
805310-01	PRIMARY/SECONDARY SEAT KIT		1	\$	63.40
805311-01	PISTON & SEAL KIT**	Service Item	1	\$	99.00
805312-01	PRIMARY/SECONDARY SEAL KIT		1	\$	15.90
805313-01	P.R. COVER STATIC SEAL KIT		1	\$	23.80
805314-01	PRESS TO TEST SHAFT KIT**		1	\$	99.80
805315-01	PR REDUCER COVER SCREW KIT		1	\$	27.00
805318-01	EZ FLO REG VIBRALERT KIT		1	\$	353.60
805319-01	EZ FLO REG PURGE BODY KIT		1	\$	71.80
805320-01	EZ FLO REGULATOR SEAL KIT		1	\$	26.10
805321-01	DEMAND VALVE PISTON KIT		1	\$	61.40
805322-01	EZ FLO PURGE STEM KIT		1	\$	27.00
805323-01	EZ FLO DEMAND LEVER KIT		1	\$	22.60
805324-01	EZ FLO REG LATCH PLATE KIT		1	\$	20.50
805329-01	AP50 HARNESS & BUCKLE KIT		1	\$	849.70
805330-06	CONSOLE CVR KIT,PAK-ALERT SE+		1	\$	26.13
805337-11	MASK FACEPIECE ASSEMBLY		1	\$	250.00
805337-12	MASK FACEPIECE ASSY		1	\$	250.00
805337-13	MASK FACEPIECE ASSY		1	\$	250.00
805339-01	VOICEMITTER DUCT ASSY., LEFT		1	\$	14.60
805339-02	VOICEMITTER DUCT ASSY., RIGHT		1	\$	14.60
805345-01	FENESTRA, DRILLED		1	\$	125.00
805353-01	AUX EXHALATION VALVE ASSY		1	\$	101.00
805358-01	BATTERY PACK ASY,C420 PAPR		1	\$	120.80
805359-01	DECONTAMINATION BELT ASY,C420P		1	\$	65.00
805374-01	AIRFLOW INDICATOR ASY,C420PAPR		1	\$	36.10
805381-02	POSI-CHEK INTERFACE, MIDRANGE		1	\$	2,950.00
805381-04	POSI-CHEK INTERFACE MR L/TOOLS		1	\$	2,080.00
805381-05	Posi3 USB Interface Kit		1	\$	3,460.00
805381-06	Posi3 USB Interface Kit L/Tool		1	\$	2,700.00
805385-01	UNIV SPRING COMPRESSOR ASSY		1	\$	126.90
805402-02	LOOP, WEBBING		1	\$	22.60
805421-01	SWAT SHOULDER PAD ASSEMBLY		1	\$	355.70
805423-01	WAIST PAD ASSEMBLY		1	\$	293.30
805425-01	SWAT BELT WAIST TO SHOULDER		1	\$	125.80

805427-01	SWAT WAIST BELT FEMALE CONNECT		1	\$	70.00
805429-01	CYLINDER RETENTION ASSEMBLY		1	\$	185.00
805435-03	MOT-GP,GTX,LTS,P,SP,MP,SPRT,AP		1	\$	503.69
805435-04	MOT-GP,HT,JT,MT(S,X)STLTH,XTS		1	\$	518.32
805435-09	MOT-ASTRO,SABER,MX		1	\$	674.03
805435-17	KENWD--TK-& TH-SER.,ATE		1	\$	518.32
805435-34	KENWD-TK(28,38,39,48)0,481		1	\$	503.69
805435-68	MOT-HT(750,1250,1550)		1	\$	503.69
805435-71	GE/ERICSSON JAGUAR P-700		1	\$	1,595.00
805435-75	YAESU-VERTEX VX800/900		1	\$	697.00
805435-78	MOTOROLA GP, EX500/600		1	\$	716.87
805435-91	ICOM; F60 & F1103		1	\$	786.89
805435-95	MOTOROLA, MOTOTRBO XPR-		1	\$	777.48
805438-01	WELD-O-VISTA,KEV/H,EPDM SEAL,S		1	\$	400.00
805438-02	WELD-O-VISTA,KEV/H,EPDM SEAL,L		1	\$	400.00
805438-03	WELD-O-VISTA,KEV/H,EPDM SL,XL		1	\$	400.00
805438-08	WELD-O-VISTA,KEV/H,EPDM SL,CS		1	\$	400.00
805438-21	WELD-O-VISTA,RUB/H,EPDM SEAL,S		1	\$	346.00
805438-22	WELD-O-VISTA,RUB/H,EPDM SEAL,L		1	\$	346.00
805438-23	WELD-O-VISTA,RUB/H,EPDM SL,XL		1	\$	346.00
805438-28	WELD-O-VISTA,RUB/H,EPDM SL,CS		1	\$	346.00
805438-41	WOV KEV HH/EPDM W/SHROUD (S)		1	\$	557.00
805438-42	WOV KEV HH/EPDM W/SHROUD (L)		1	\$	557.00
805438-43	WOV KEV HH/EPDM W/SHROUD (XL)		1	\$	557.00
805438-48	WOV KEV HH/EPDM W/SHROUD (CS)		1	\$	557.00
805442-02	HOSE & SOCKET ASSEMBLY		1	\$	347.40
805443-01	RIT, HANSEN PLUG W/LANYARD		1	\$	79.70
805443-03	CEJN PLUG W/LANYARD		1	\$	95.00
805450-13	CHARGING WAND ASSY, RIT-PAK		1	\$	901.70
805450-23	CHARGING WAND ASSY, RIT-PAK		1	\$	1,130.00
805454-413	SWAT-PAK FR, 2.2, W/CASE		1	\$	4,680.00
805454-416	4500 SWAT-PK FIRST RESPOND ED		1	\$	4,940.00
805454-417	SWAT-PAK FR, 4.5, W/EBSS/CASE		1	\$	5,570.00
805454-418	4500 SWAT-PK FIRST RESPOND ED		1	\$	5,570.00
805454-60	SWAT-PAK, 4.5, W/CASE		1	\$	3,820.00
805458-01	SWAT-PAK 6'EBSS HOSE & POUCH		1	\$	427.40
805460-01	CARRIER FRAME, RIT PAK		1	\$	459.70
805471-01	ASSEMBLY, LINE MOUNT PLUG**		1	\$	26.10
805472-01	BELL, REPLACEMENT 4.5		1	\$	406.60
805472-07	BELL, REPLACEMENT 2.2		1	\$	406.60
805511-01	AP50 CHEST STRAP ASSEMBLY		1	\$	33.30
805511-02	CHEST STRAP ASSEMBLY WITH SNAP		1	\$	43.70
805532-BA0959	CYL CARB, 30MIN, 4500 PSI		1	\$	840.00
805532-EA0500	CYL CARB, 30MIN, 4500 PSI		1	\$	840.00
805534-01	MASK BAG, LIGHTWEIGHT FLEECE		1	\$	26.00
805536-01	WOV LENS SEPARATOR&RETAINER KT		1	\$	12.60
805537-01	WELD-O-VISTA LENS ASSEMBLY KIT		1	\$	200.00
805557-01	MPC PLUS CARTRIDGE		1	\$	23.00
805570-01	PA SE LEAK TESTER KIT**		1	\$	1,092.03
805571-01	EI LENS HOUS ADP ASY		1	\$	113.00
805572-01	PAK-ALERT ADAPTER ASSEMBLY		1	\$	253.80
805573-01	EI CAMERA HS ADP ASY		1	\$	28.00
805574-01	WOV LENS ASY,EPDM,W/NSCP&VCMTR		1	\$	257.00
805600-01	HANDWHEEL KIT		1	\$	66.60
805621-18	EI I TCS, 12 VDC		1	\$	742.00
805622-01	TWIN QUARTER TURN ADAPTER ASSY		1	\$	43.50
805628-01	40MM FIT TEST ADAPTER ASSY		1	\$	53.00
805629-01	CHIN CAN FIT TEST ADAPT ASSY		1	\$	42.70
805630-01	REPLACEMENT KIT,FIT TEST ADAPT		1	\$	10.40
805655-01	SEAL, MASK KIT		1	\$	29.20
805659-006	SUPPLY HOSE, 6' (CEJN)EZAL		1	\$	150.00

805659-025	SUPPLY HOSE, 25' (CEJN)		1	\$	230.00
805659-050	SUPPLY HOSE, 50' (CEJN)EZAL		1	\$	340.00
805659-100	SUPPLY HOSE, 100' (CEJN)		1	\$	460.00
805679-00	BASE UNIT, SEMS		1	\$	4,047.29
805679-01	BASE UNIT, SEMS		1	\$	5,578.21
805680-01	PORTABLE UNIT, SEMS,2216 PSI		1	\$	2,620.00
805680-02	PORTABLE UNIT, SEMS, 4500 PSI		1	\$	2,084.78
805680-03	PORTABLE UNIT, SEMS,3000 PSI		1	\$	2,060.00
805693-01	EZ FLOII,STD HOSE		1	\$	976.60
805693-10	EZFLO II,HUD QD HOSE		1	\$	1,400.00
805693-11	EZFLOII,HUD LONG HOSE		1	\$	1,390.00
805701-01	HAZMAT RADIOCOM W/PADDLE PTT		1	\$	1,219.52
805701-02	HRCM W/P PTT MOT:HT,MT,MTX		1	\$	795.25
805701-03	HAZMAT RADIOCOM W/PADDLE PTT		1	\$	795.25
805701-04	HAZMAT RADIOCOM W/PADDLE PTT		1	\$	795.25
805701-17	HAZMAT RADIOCOM W/PADDLE PTT		1	\$	703.29
805701-34	HAZMAT RADIOCOM W/PADDLE PTT		1	\$	771.21
805701-68	HAZMAT RADIOCOM W/PADDLE PTT		1	\$	795.25
805701-69	HAZMAT RADIOCOM W/PADDLE PTT		1	\$	882.00
805701-71	HAZMAT RADIOCOM W/PADDLE PTT		1	\$	1,684.54
805701-75	HAZMAT RADIOCOM W/PADDLE PTT		1	\$	795.25
805701-77	HAZMAT RADIOCOM W/PADDLE PTT		1	\$	1,096.21
805701-83	EF JOHNSON 5100		1	\$	1,027.24
805701-91	HAZMAT RADIOCOM W/PADDLE PTT		1	\$	996.93
805701-95	HAZMAT RADIOCOM W/PADDLE PTT		1	\$	996.93
805746-03	CEJN SOCKET ASSY		1	\$	218.40
805746-04	36"HOSE&SCKT,LANYD W/CLMP		1	\$	417.00
805746-05	72"HOSE&SCKT,LANYD W/CLMP		1	\$	580.30
805746-06	4"HOSE&SCKT,LANYD W/CLMP		1	\$	403.50
805753-01	AV3000 SPECTACLE KIT ASSY		1	\$	55.00
805767-01	HOSE ASSEMBLY, EBSS		1	\$	149.80
805767-02	HOSE ASSEMBLY, EBSS		1	\$	149.80
805769-01	HOSE & MANIFOLD ASSEMBLY		1	\$	568.90
805769-02	HOSE & MANIFOLD ASSEMBLY		1	\$	568.90
805771-01	FACE SEAL,SMALL,POLYISOPRENE		1	\$	145.00
805771-02	FACE SEAL,MEDIUM,POLYISOPRENE		1	\$	145.00
805771-03	FACE SEAL, LARGE,POLYISOPRENE		1	\$	145.00
805773-01	AV-3000(S) KVLR		1	\$	317.00
805773-02	AV-3000(M) KVLR		1	\$	317.00
805773-03	AV-3000(L) KVLR		1	\$	317.00
805773-07	AV-3000(S) KVLR, W/BRKT		1	\$	344.00
805773-08	AV-3000(M) KVLR, W/BRKT		1	\$	344.00
805773-09	AV-3000(L) KVLR, W/BRKT		1	\$	344.00
805773-71	AV-3000(S) KVLR		1	\$	317.00
805773-72	AV-3000(M) KVLR		1	\$	317.00
805773-73	AV-3000(L) KVLR		1	\$	317.00
805773-74	AV-3000(S) KVLR, W/BRKT		1	\$	344.00
805773-75	AV-3000(M) KVLR, W/BRKT		1	\$	344.00
805773-76	AV-3000(L) KVLR, W/BRKT		1	\$	344.00
805773-81	AV3 W/SURESEAL(S) KVLR		1	\$	311.00
805773-82	AV3 W/SURESEAL(M) KVLR		1	\$	311.00
805773-83	AV3 W/SURESEAL(L) KVLR		1	\$	311.00
805773-84	AV3 W/SURESEAL(S) KVLR, W/BRKT		1	\$	337.00
805773-85	AV3 W/SURESEAL(M) KVLR, W/BRKT		1	\$	337.00
805773-86	AV3 W/SURESEAL(L) KVLR, W/BRKT		1	\$	337.00
805774-07	AV3K, POLY HH, GRAY NC, SM		1	\$	238.00
805774-08	AV3K, POLY HH, GRAY NC, MD		1	\$	238.00
805774-09	AV3K, POLY HH, GRAY NC, LG		1	\$	238.00
805774-81	AV3K, POLY , SURESEAL, SMALL		1	\$	233.00
805774-82	AV3K, POLY , SURESEAL, MED		1	\$	233.00
805774-83	AV3K, POLY , SURESEAL, LRG		1	\$	233.00

805775-07	AV3K, RBR HARN, GRAY NC, SM		1	\$	249.00
805775-08	AV3K, RBR HARN, GRAY NC, MD		1	\$	249.00
805775-09	AV3K, RBR HARN, GRAY NC, LG		1	\$	249.00
805775-81	AV3SS, RBR HARN, GRAY NC, SM		1	\$	233.00
805775-82	AV3SS, RBR HARN, GRAY NC, MD		1	\$	233.00
805775-83	AV3SS, RBR HARN, GRAY NC, LG		1	\$	233.00
805782-01	VALVE, ASSY 2216 PSI		1	\$	432.60
805783-01	VALVE, ASSY 4.5 PSI		1	\$	432.60
805783-02	ASSY, NXG CYLINDER VALVE		1	\$	432.60
805784-01	WIKA GAUGE ASSY, AIR-PAK 2.2 *		1	\$	425.40
805784-02	WIKA GAUGE ASSY, AIR-PAK 4.5		1	\$	425.40
805784-03	WIKA GAUGE ASSY, AIR-PAK 3.0		1	\$	425.40
805787-01	AV3000 AUDIO ACCSY CLAMP,KIT		1	\$	55.39
805787-02	AUDIO ACCSY CLAMP,KIT		1	\$	55.39
805794-01	CONTROL MOD ASSY,PAK-ALERT SE+	Service Item	1	\$	810.92
805794-02	CONTROL MODULE - SEMS PDA	Service Item	1	\$	797.34
805794-03	PAK-AERT SE+W/PAK-TRACKER	Service Item	1	\$	1,051.27
805794-61	CONTRL MOD ASY,PAK-ALERT SE60+		1	\$	822.60
805807-01	KIT, LABEL, BEZEL, USER NAME		11	\$	6.20
805808-01	HEADNET ASSY,KEVLAR, STD -KB-		1	\$	169.00
805808-02	HEADNET ASSY,KEVLAR, LARGE-KB-		1	\$	169.00
805809-01	HEADNET ASSY,POLY, STD		1	\$	77.00
805809-02	HEADNET ASSY,POLY, LG		1	\$	77.00
805810-01	PF2 PAPR,CHRGR,40MM ADAPTER		1	\$	1,001.00
805810-03	PF2 PAPR,CHRGR		1	\$	993.00
805816	ADAPTER KIT, OHD/XCEL FIT TEST		1	\$	413.00
805820-01	PF3 PAPR,CHRGR,(NO HOSE)		1	\$	1,073.30
805820-06	PF3 PAPR,CHGR,LG BUTYL HD W/HHS		1	\$	1,427.00
805825-01	SMAC-1,2 OUTLET,HANSEN, L/CYL		1	\$	2,520.00
805825-04	MOBILE AIR CART,SCH,CYL DECK		1	\$	2,520.00
805826-01	SMAC-2,4 OUTLET,HANSEN, L/CYL		1	\$	2,650.00
805826-04	MOBILE AIR CART,SCH,CYL DECK		1	\$	2,650.00
805827-01	SMAC-3,4 OUTL W/TOOL,L/CYL		1	\$	3,070.00
805827-04	MOBILE AIR CART,SCH,CYL DECK		1	\$	3,070.00
805827-07	MOBILE AIR CART,FOSTER,CYL DK		1	\$	3,070.00
805827-13	MOBILE AIR CART,CEJN,CYL DECK		1	\$	3,780.00
805833-01	BATTY COMPARTMENT ASSY,AIR-PAK		1	\$	289.10
805884-01	ASSEMBLY, 4.5 CGA		1	\$	157.00
805885-01	ASSEMBLY, 2.2, CGA		1	\$	157.00
805896-11	PAD ASSY,SHLDR,STIFF,LEFT MAL		1	\$	124.80
805896-21	PAD ASSY,SHDR,STIFF,RIGHT,MAL		1	\$	124.80
805898-01	SEMS PDA KIT,2216 (FIELD INST)		1	\$	2,300.00
805898-02	SEMS PDA KIT,3000 (FLD INSTL)		1	\$	2,300.00
805898-03	SEMS PDA KIT,4500 (FLD INSTL)		1	\$	2,300.00
805917-02	NXG ELECT ENCL ASSY 4.5 PASS *		1	\$	1,130.00
805918-01	NXG2 PASS & GAUGE ASY,2216 PSI		1	\$	2,160.00
805918-02	NXG2 PASS & GAUGE ASY,4500 PSI		1	\$	2,290.00
805938-01	TOP ENCLOSURE KIT, SE+		1	\$	370.98
805938-02	TOP ENCLOSURE KIT,SE+		1	\$	414.87
805938-62	TOP ENCLOSURE KIT,SE+/SE60+		1	\$	421.14
805947-02	CYL&VLV,CARB,5 MIN 3.0 LOW RE		1	\$	550.00
805948-02	CYL&VLV,CARB,10 MIN 3.0 LOW R		1	\$	620.00
805954-02	ASSEMBLY,EEOSTI,4500 PSI		1	\$	560.00
805954-03	ASSEMBLY, EEOSTI, 3000 PSI		1	\$	560.00
805954-04	ASSEMBLY, EEOSTI A/T 2216 PSI		1	\$	560.00
805954-05	ASSEMBLY, EEOSTI A/T 3000 PSI		1	\$	560.00
805954-06	ASSEMBLY, EEOSTI A/T 4500 PSI		1	\$	560.00
805955-01	LED ASSY, ELECTRONICS ENCLOSRE		1	\$	78.00
805964-01	REMOVABLE WAIST STRAP		1	\$	66.60
805964-02	STRAP,WAIST,REMOVABLE		1	\$	66.60
89105-01	RECORD CARD,MAINTENANCE		1	\$	2.10

AB10009	VALVE, NEEDLE		1	\$	17.00
AB10064	VALVE, 2ND STAGE SUCTION-7		1	\$	429.00
AB10065	VALVE, 2ND STG DELIVERY-7		1	\$	670.00
AB10244	SEAL, OIL FRONT CRANKCASE-24		1	\$	23.00
AB10860	PAD, PISTON END		1	\$	27.00
AB110-0019	DANGER LABEL, AIR		1	\$	9.70
AB110-0046	ASME RECEIVER ADAPTER WELDMT		1	\$	141.00
AB110-0072	BOLT, 1/4-20X.500 GRD 2 HXHD ZI		1	\$	0.30
AB110-0095	MODIFIED DOOR WELDMENT		1	\$	2,005.41
AB110-0096	FAN SHROUD, INGERSOLL COMPRESS		1	\$	172.00
AB110-0099	BEARING BLOCK ASSY		1	\$	164.00
AB110-0116	MOTOR MONITOR MOUNT BRACKET		1	\$	49.35
AB110-0117	OFFSET ROCKER, REVOLVE AIR		1	\$	16.00
AB110-0140	CYLINDER LOADING RACK, GUARDIAN		1	\$	139.00
AB110-0148	PRIMARY FUSE BLOCK		1	\$	93.00
AB110-0177	COUPLER, 2-5/16 BALL		1	\$	217.00
AB110-0213	COVER, REEL CORD		1	\$	54.65
AB110-0215	SIDE PANEL ASSY, LH TANDEM		1	\$	1,740.00
AB110-0218	SIDE PANEL ASSY, RH TANDEM		1	\$	1,740.00
AB110-0247	PURIFIER MOUNT WELDMENT		1	\$	393.00
AB110-0273	INSULATION, 3/4" FOAM, BLUE, R4		1	\$	52.00
AB110-0276	SUPPORT BAR (INSIDE FRAME/PUR)		1	\$	33.00
AB110-0292	SURGE SUPPRESSOR		1	\$	71.00
AB110-0320	MODIFICATION INST. SCUBA (REV-AIR		1	\$	0.20
AB110-0321	SCUBA KIT INST & USE INSTR		1	\$	0.10
AB110-0348	PIPE COUPLING, 1-1/4 NPT		1	\$	13.00
AB110-0349	BLACK STEEL PIPE NIPPLE, 3"		1	\$	7.20
AB110-0350	BLACK STEEL PIPE NIPPLE, 4"		1	\$	9.40
AB110-0356	CABLE TIE HOLDER/ALLEN WR HLDR		1	\$	0.70
AB110-0358	CABLE TIES, 4"		1	\$	0.20
AB110-0414	HINGE, ELEC. DOOR		1	\$	146.00
AB110-0440	SPACER, TRUNNION VALVE		1	\$	19.00
AB110-0444	LIGHT REEL MOUNT		1	\$	57.61
AB110-0457	HYD. SURGE BRAKE ACTUATOR		1	\$	1,210.00
AB110-0488	COVER, FRONT, L./R. H. RED BARON		1	\$	76.00
AB110-0490	230VAC DUMP SOLENOID		1	\$	250.00
AB110-0491	FITTING, END TRUNNION VALVE		1	\$	40.00
AB110-0492	FITTING, END GASKET TRUN VALVE		1	\$	4.80
AB110-0508	VALVE, 1/4NPT 6000 PSIG		1	\$	109.00
AB110-0514	DUMMY ASME, FOR 1 TANK RACK		1	\$	31.00
AB110-0516	CHECK VALVE, H15T6		1	\$	452.00
AB110-0535	DECAL, PARKING BRAKE		1	\$	0.20
AB110-0536	DECAL, WARN, BRAKE/LIGHT TOWER		1	\$	0.10
AB110-0541	TEE, 1/4 NPTF MALE PIPE		1	\$	29.00
AB110-0581	DUMMY ASME, 3&5 TANK RACKS		1	\$	32.00
AB110-0582	TERMINAL SPLITTER, DBL MALE		1	\$	0.50
AB110-0585	NO STEP DECAL		1	\$	3.60
AB110-0588	SAFETY ASSEMBLY		1	\$	3.40
AB110-0591	NIPPLE COUPLING		1	\$	12.60
AB110-0597	DECAL, SBAS APPLIQUE 9X14		1	\$	32.50
AB110-0598	COIL, DUMP SOLENOID 230VAC		1	\$	80.00
AB110-0600	PANEL, 4 GAGE FRONT		1	\$	138.00
AB110-0639	ADAPTER, CGA702 FEMX1/4NPTF BRS		1	\$	63.00
AB110-0640	1-1/2" CLAMP LIGHT TOWER MAST		1	\$	54.00
AB110-0641	MOTOR, 7.5HP, 50HZ, 3PH, 2850 RPM		1	\$	1,350.00
AB110-0642	COVER, WALL MOUNT		1	\$	44.00
AB110-0687	DUMP CAN HOLDER, TRAILER		1	\$	109.00
AB110-0697	BOX, LIGHT TOWER		1	\$	245.00
AB110-0701	SHAFT, ENGINE		1	\$	330.00
AB110-0721	CONTACTOR, 7.5HP\15HP		1	\$	203.00
AB110-0723	CONTACTOR, 10HP, 208/240V/3PH		1	\$	152.00

AB110-0724	CRANKCASE OIL FILTER NA12&NA18		1	\$	23.00
AB110-0725	CONTACTOR,5HP,208/240V/1PH		1	\$	147.00
AB110-0726	CONTACTOR,5HP,208/240V/3PH		1	\$	114.00
AB110-0727	CONTACTOR,10HP,208/240V/1PH		1	\$	163.00
AB110-0750	WHEEL & TIRE ASSEMBLY 16"		1	\$	721.00
AB110-0764	LIFT AND TURN LATCH		1	\$	30.00
AB110-0765	GENERATOR,7.2KW,120/240V 360		1	\$	1,540.00
AB110-0767	FUSE,.8A 600VAC		1	\$	37.00
AB110-0768	FUSE,.6A 600VAC		1	\$	37.00
AB110-0790	CONTROLLER CABLE,40FT LONG		1	\$	358.00
AB110-0806	SCREW,1/4-20 X 5/8 PAN HD PHIL		1	\$	0.55
AB110-0819	QUARTZ FLOOD LIGHT,300 WATT		1	\$	66.00
AB110-0821	REMOTE INTAKE,COLTRI 5 & 7.5HP		1	\$	49.50
AB110-0822	REMOTE INTAKE,HAM 7.5 & 10 HP		1	\$	322.60
AB110-0822E	REMOTE INT ENCL,HAM 7.5&10 HP		1	\$	135.00
AB110-0824	REMOTE INTAKE,ING 15 & 20HP		1	\$	242.40
AB110-0824E	REMOTE INT ENCL,IR 15&20HP		1	\$	250.80
AB110-0891	INLET VACUUM AIR FILTER		1	\$	264.00
AB110-0895	MOTOR,7.5HP,208VAC 1PH		1	\$	2,005.41
AB110-0899	MOTOR,10HP,208VAC 1PH		1	\$	1,984.00
AB110-0920	FAN BELT,LOMBARDINI		1	\$	107.00
AB110-0934	DISC,9KSI BURST		1	\$	5.35
AB110-0935	CORDSET,125V TWIST LOCK		1	\$	205.00
AB110-0962	COIL,DUMP SOLENOID,12VDC		1	\$	78.00
AB110-0965	BUTTON,OVERLOAD RESET		1	\$	22.00
AB110-0974	1/4-20UNC X .5 HX HD BOLT ZINC		1	\$	0.30
AB110-0999	DOT WALL MOUNT,34" UN-STRUT		1	\$	155.00
AB110-1012	FUSE, .6A,380VOLT		1	\$	5.70
AB110-1014	PURIFICATION BASE		1	\$	368.00
AB110-1015	GROMMET,2.88 OD X 2.125 ID		1	\$	6.00
AB110-1019	CONTACTOR,10HP 50Z,380V 3PH		1	\$	145.00
AB110-1020	CORD GRIP, 90 DEGREE		1	\$	56.00
AB110-1023	VALVE,RELIEF ADJUSTMENT,6500		1	\$	162.00
AB110-1024	LUNETTE EYE,3"		1	\$	100.00
AB110-1032	FUSE,2.5A,250V, CERAMIC		1	\$	4.60
AB110-1052	X4 E-STOP, HORN & CABLE KIT		1	\$	151.41
AB110-1055	LOMBARD ENG CONTROL BX, RECT		1	\$	831.00
AB110-1056	LOMBARD ENG CONTROL BX,SQUARE		1	\$	872.55
AB110-1069	1/8NPT-165LB-SAFETY VALVE		1	\$	21.00
AB110-1070	1/8TUBEX1/8NPT STR PRESTOLOK		1	\$	5.90
AB110-1076	BELT,ENGINE/7.2 GENERATOR,TRAI		1	\$	97.00
AB110-1079	GEN PULLEY,ENG/GEN ON TRAIL		1	\$	157.00
AB110-1081	PISTON,VALVE		1	\$	194.00
AB110-1082	O-RING		1	\$	14.90
AB110-1103	V-BELT NOTCHED 86 LONG (OD)		1	\$	28.35
AB110-1108	SEQUENCE VALVE-6000 PSI		1	\$	351.00
AB110-1118	CONTR 60HP,60HZ,230V,3PH		1	\$	758.00
AB110-1120	RELAY,60HP,230V,3PH THERM OVLD		1	\$	650.00
AB110-1132	CONTROLLER CABLE,50 FT LONG		1	\$	379.00
AB110-1133	SOLENOID/CONN ASSY,HIGH SPEED		1	\$	144.00
AB110-1134	SOLENOID/CONN ASSY, CLUTCH		1	\$	225.00
AB110-1165	KEY,REPLACEMENT		1	\$	10.85
AB110-1245	BELT GUARD BASE 60 HZ GENERATO		1	\$	141.00
AB110-1246	BELT GUARD FRONT COVER 60 HZ G		1	\$	82.80
AB110-1265	SHIM(.010)		1	\$	9.40
AB110-1268	INTAKE FILTER CARTRIDGE		1	\$	24.00
AB110-1281	STRAP, CONDENSATE CONTAINER		1	\$	269.00
AB110-1302	HOSE, HYD, 1-1/4ID, NO SKIVE		1	\$	2.50
AB110-1318	CABLE 1AWG LOCOMOTIVE		1	\$	0.90
AB110-1324	WIRE, 4 AWG, GREEN		1	\$	0.40
AB110-1325	FLEX. COND. 2" GRAY		1	\$	1.40

AB110-1327	QUICK DISC. SOCKET 3/8		1	\$	45.00
AB110-1335	1/4 FLAREX1/4NPT SWIVEL CONNEC		1	\$	20.00
AB110-1336	SCREW,HX HD, 10-32, 1/2 LONG		1	\$	0.28
AB110-1345	IDLER ADJUSTING ARM, TRAILERS		1	\$	130.00
AB110-1346	IDLER ROLLER IDLER ARM TRAILER		1	\$	147.00
AB110-1347	SCREW, M12 X 1.75 X 110MM,SHCS		1	\$	5.05
AB110-1348	NUT, LOCKNUT, M12 X 1.75MM, HE		1	\$	14.80
AB110-1352	FLOW FUSE MOD443 6KPSI 1/4NPT		1	\$	78.00
AB110-1355	FUSE,1A,600V,FNQ-R		1	\$	29.00
AB110-1359	NUT, NYLON LOCKNUT 5/16-18		1	\$	0.21
AB110-1360	NUT, NYLON LOCKNUT 3/8-16		1	\$	0.50
AB110-1363	SCREW, SHCS 3/8-16 X 2.00		1	\$	1.20
AB110-1385	GAUGE, RED LINED, 0-10,000 PSI		1	\$	116.00
AB110-1386	MOTOR,5HP,208VAC 1PH		1	\$	677.00
AB110-1387	GAUGE,BTM MNT,0-10,000 PSI		1	\$	116.00
AB110-1398	OIL LEVEL SWITCH		1	\$	245.00
AB110-1399	O-RING FOR OIL SWITCH		1	\$	9.80
AB110-1402	WASHER FOR ACORN NUT (1ST STAG		1	\$	14.90
AB110-1403	O-RING, LARGE, 1ST STAGE		1	\$	6.80
AB110-1404	O-RING, SMALL, 1ST STAGE		1	\$	7.20
AB110-1405	VALVE ASSEMBLY, COMPLETE, 1ST		1	\$	792.00
AB110-1406	COPPER WASHER, UPPER, 2ND STAG		1	\$	63.00
AB110-1407	VALVE ASSEMBLY, 2ND STAGE		1	\$	1,815.00
AB110-1408	COPPER WASHER, LOWER, 2ND STAG		1	\$	64.00
AB110-1409	VALVE ASSEM COMP W/SEALS, 3RD		1	\$	2,366.00
AB110-1410	VALVE ASSEM COMP W/SEALS, 4TH		1	\$	2,218.00
AB110-1411	CHECK VALVE, CONDENSATE TRAY &		1	\$	719.00
AB110-1412	REAR CRANKCASE COVER GASKET		1	\$	40.00
AB110-1413	GAUGE, 0-100PSI		1	\$	130.00
AB110-1414	GAUGE, 0-600PSI		1	\$	206.00
AB110-1415	GAUGE, 0-2000PSI		1	\$	206.00
AB110-1416	GAUGE, 0-10,000PSI		1	\$	205.00
AB110-1417	OIL SWITCH (H15T6)		1	\$	552.00
AB110-1418	OIL FILL CAP (H15T6)		1	\$	115.00
AB110-1419	4TH STAGE SAFETY DISC		1	\$	127.00
AB110-1420	VALVE GASKET, 88MM, 1ST STAGE		1	\$	54.00
AB110-1421	VALVE GASKET, 95MM, 1ST STAGE		1	\$	54.00
AB110-1422	VALVE ASSEMBLY, 1ST STAGE		1	\$	623.00
AB110-1423	VALVE GASKET, LOWER, 1ST STAGE		1	\$	65.00
AB110-1425	INLET VALVE, 2ND STAGE		1	\$	179.00
AB110-1427	EXHAUST VALVE, 2ND STAGE		1	\$	268.00
AB110-1428	O-RING, 2ND STAGE		1	\$	6.00
AB110-1429	SAFETY RELEIF VALVE, 2ND STAGE		1	\$	208.00
AB110-1430	INLET VALVE, 3RD STAGE		1	\$	149.00
AB110-1431	EXHAUST VALVE, 3RD STAGE		1	\$	149.00
AB110-1432	O-RING EXHAUST VALVE 3RD STAGE		1	\$	6.00
AB110-1433	UPPER CAP, CONDENSATE SEPARATO		1	\$	119.00
AB110-1434	O-RING, UPPER OR LOWER		1	\$	6.00
AB110-1435	LOWER CAP,CONDENSATE SEPARATOR		1	\$	60.00
AB110-1436	UPPER CAP, PURIFIER		1	\$	65.00
AB110-1437	INTERNAL CAP, PURIFIER		1	\$	65.00
AB110-1438	LOWER CAP, PURIFIER		1	\$	65.00
AB110-1439	LOWER BODY, PMV		1	\$	190.00
AB110-1440	STEEL BALL, PMV		1	\$	11.70
AB110-1441	PISTON, PMV		1	\$	90.00
AB110-1442	BELLEVILLE WASHER SET, PMV		1	\$	90.00
AB110-1443	CAP, PMV		1	\$	119.00
AB110-1444	COPPER VALVE GASKET		1	\$	6.00
AB110-1445	OIL FILLER CAP		1	\$	19.10
AB110-1464-1	DEW POINT SENSOR WITH CABLE		1	\$	409.00
AB110-1464-2	C/O SENSOR WITH CABLE		1	\$	711.00



AB110-1464-4	SBAS CONTROLLER I/O BOARD		1	\$	325.00
AB110-1464-5	SOFTWARE DOWNLOAD CABLE		1	\$	116.00
AB110-1464-6	STATIONARY CONTROLLER CABLE		1	\$	271.00
AB110-1464-7	MOBILE CONTROLLER CABLE		1	\$	163.00
AB110-1464-8	CABLE ADAPTER, 25'		1	\$	299.00
AB110-1464-8100	EXTENSION CABLE, 100ft		1	\$	573.10
AB110-1464-850	EXTENSION CABLE, 50ft		1	\$	421.60
AB110-1464-875	EXTENSION CABLE, 75ft		1	\$	497.35
AB110-1476	NAMEPLATE, TRAILER, LIBERTY		1	\$	15.00
AB110-1557	NIPPLE, 1/8 X 2.5" NPT		1	\$	7.20
AB110-1560	PNL,CNTRL,W/X4,LIB I-36		1	\$	178.50
AB110-1561	ELBOW1/8TUBEX1/4NPT SWIVEL PRE		1	\$	23.00
AB110-1563	ELBOW1/8TUBEX1/8NPT PRESTOLOK		1	\$	9.70
AB110-1564	1/8NPT-250LB-SAFETY VALVE		1	\$	21.00
AB110-1566	MOTOR,15HP/208V/3PH/60HZ		1	\$	1,867.39
AB110-1567	MOTOR,20HP/208V/3PH/60HZ		1	\$	3,661.00
AB110-1573	ADAPTER, 1/4BSPP X 1/4NPTF		1	\$	21.00
AB110-1574	PRESS RELIEF VALVE 650PSIG ASM		1	\$	113.00
AB110-1575	PRESS RELIEF VALVE 1400PSIG AS		1	\$	116.00
AB110-1600	THERMOCOUPLE-TYPE J		1	\$	114.00
AB110-1601	4ANX1/8NPTSWIVELSTRT		1	\$	28.00
AB110-1602	4ANX1/4NPTBLKHD		1	\$	43.00
AB110-1607	REGULATOR-INLINE-REDUCING		1	\$	190.00
AB110-1615	SEAT, PURGE VALVE		1	\$	40.00
AB110-1616	SPOOL,PURGE VALVE		1	\$	21.00
AB110-1617	O-RING, .114 X .070, #2-006		1	\$	0.30
AB110-1618	O-RING, 1.364 X .070, #2-028		1	\$	0.80
AB110-1623	COLTRI 3RD ST. DUMP VLV KIT		1	\$	349.80
AB110-1646	PISTON SWITCH 3650-7500PSI ADJ		1	\$	173.00
AB110-1651	MOTOR 20HP 1760RPM 208/460V OD		1	\$	1,724.00
AB110-1658	STRAIN RELIEF, LIQUID TIGHT		1	\$	10.70
AB110-1660	O-RING SEAL		1	\$	1.70
AB110-1674	TOP STRAP MOUNT		1	\$	106.00
AB110-1686	COLTRI FILTER ACCESS COVER		1	\$	1,985.00
AB110-1692	12" BEADED CHAIN		1	\$	0.20
AB110-1699	GAUGE-1.5"-DUAL READING PRESSU		1	\$	40.00
AB110-1700	REGULATOR,LP,PURGE VALVE		1	\$	118.00
AB110-1702	MUFFLER, 210 CFM EXHAUST		1	\$	38.00
AB110-1704	NUT-PANEL MNT REGULATOR		1	\$	5.60
AB110-1707	CLAMP .68 - 1.25 SS WORM DRIVE		1	\$	3.60
AB110-1709	UNION, HEX, 4AN X 4AN		1	\$	8.00
AB110-1710	ADAPTER, FEM DIN X 1/4 NPT FEM		1	\$	31.75
AB110-1713	FILTER-1/8NPT INLINE,40 MICRON		1	\$	19.00
AB110-1714	DANGER LABEL WHEEL LUG TORQUE		1	\$	39.75
AB110-1715	BOLT 5/8-11 X 3-1/2 GRD 8 HXHD		1	\$	8.20
AB110-1716	TENSIONER MOUNT IDLER TRAILER		1	\$	124.00
AB110-1717	SEAL COPPER HEAD VALVE BODY 4T		1	\$	13.80
AB110-1718	BACK-UP RING TEFLON 4TH STAGE		1	\$	17.00
AB110-1719	RING RETAINING 4TH STAGE		1	\$	73.00
AB110-1720	STOP INLET VALVE PLATE 4TH STA		1	\$	382.00
AB110-1721	SPRING INLET VALVE 4TH STAGE		1	\$	193.00
AB110-1722	PLATE INLET VALVE 4TH STAGE		1	\$	189.00
AB110-1723	SEAT INLET DISCHARGE 4TH STAGE		1	\$	826.00
AB110-1724	PLATE DISCHARGE 4TH STAGE		1	\$	148.00
AB110-1725	GASKET COPPER 4TH STAGE		1	\$	95.00
AB110-1726	SPRING DISCHARGE 4TH STAGE		1	\$	150.00
AB110-1727	CAGE VALVE 4TH STAGE		1	\$	1,348.00
AB110-1728	RINGS, FLOATING PISTON 4TH STA		1	\$	1,178.00
AB110-1729	GASKET UPPER FLANGE CYL/CR 4TH		1	\$	22.00
AB110-1730	GASKET LOWER FLANGE 4TH STAGE		1	\$	34.00
AB110-1731	O-RING, 4TH STAGE		1	\$	13.80

AB110-1732	BURST DISC CAP ASSY, 9000PSI		1	\$	7.50
AB110-1761	WALL MNT BRCKT,X4		1	\$	103.00
AB110-1768	PUSHER FAN FOR LDW 2204		1	\$	212.00
AB110-1802	HX BOLT 7/16X4.00 GRD5 STL		1	\$	2.52
AB110-1812	ASSY, REED VALVE, FIRST STAGE		1	\$	1,368.00
AB110-1813	EXTENSION CABLE, THERMOCOUPLE		1	\$	48.00
AB110-1830	SHAFT-MOTOR PLATE-SA COMP.		1	\$	44.87
AB110-1838	SPRING, 1/4 TURN, S.S.		1	\$	0.40
AB110-1840	12MM EXT SNAP RING		1	\$	0.30
AB110-1841	PURIFIER BASE		1	\$	198.00
AB110-1842	PURIFIER HOUSING		1	\$	859.25
AB110-1843	PURIFIER CAP		1	\$	155.00
AB110-1844	PURIFIER TUBE		1	\$	17.00
AB110-1847	COIL, DRAIN SOLENOID		1	\$	62.00
AB110-1848	SPRING-.845 O.D X 1.00 LONG		1	\$	9.30
AB110-1849	SPRING-.475 O.D X 1.00 LONG		1	\$	3.90
AB110-1850	PURIFIER STEM, LONG		1	\$	22.50
AB110-1851	PURIFIER COAL. HEX FITTING		1	\$	19.00
AB110-1865	CUP WASHER, 1/4 TURN, NYLON		1	\$	0.40
AB110-1871	SUPPORT BRKT-GUARD-HA		1	\$	54.46
AB110-1880	NUT, LOCK (1/2" NPS, ZINC)		1	\$	5.95
AB110-1890	O-RING, 2ND STG VALVE GUIDE		1	\$	7.20
AB110-1893	GASKET, 1ST STG HEAD		1	\$	30.00
AB110-1894	SEALING WASHER, 3RD STAGE		1	\$	22.00
AB110-1895	O-RING, 3RD STG VALVE ASSY		1	\$	27.00
AB110-1896	SPRING, 3RD STG DELIVERY VALVE		1	\$	30.00
AB110-1897	PLATE, 3RD STG DELIVERY VALVE		1	\$	197.95
AB110-1898	WASHER, COPPER, 3RD STG DEL VLV		1	\$	22.00
AB110-1899	PLATE, 3RD STAGE SUCTION VALVE		1	\$	191.00
AB110-1900	RING, 3RD STAGE VALVE RETAINING		1	\$	138.70
AB110-1902	VALVE REMOVAL TOOL		1	\$	86.00
AB110-1903	WASHER, 3RD STG COPPER 8MM		1	\$	5.90
AB110-1904	O-RING, 3RD STAGE VITON		1	\$	5.90
AB110-1906	O-RING, PV SAE J200		1	\$	0.30
AB110-1907	BOLT, KNURLED HEAD		1	\$	6.48
AB110-1908	NUT, TABBED (BENCH NUT)		1	\$	1.00
AB110-1909	O-RING, I/R CHECK VALVE		1	\$	5.90
AB110-1916	HINGE, DOOR, LIBERTY I		1	\$	336.00
AB110-1919	PURIFIER CHAMBER, MCH-16		1	\$	1,740.00
AB110-1920	WASHER-12MM SUPPORT		1	\$	3.33
AB110-1922	BOTTLE-CONDENSATE-SA		1	\$	26.00
AB110-1926	RECEPTICAL, 1/4 TURN, STEEL		1	\$	1.10
AB110-1927	STUD, 1/4 TURN, KNURLED		1	\$	3.70
AB110-1928	RETAINER, 1/4 TURN, NYLON		1	\$	0.30
AB110-1958	OIL FILTER, W70H-AL		1	\$	112.00
AB110-1959	INTAKE OIL SEPARATOR W70H-AL		1	\$	545.00
AB110-1966	DRILL TEMPLATE, LE4000		1	\$	17.00
AB110-1967	Heat Tap		1	\$	23.00
AB110-1987	8" PIPE CLAMP, STRUT		1	\$	19.32
AB110-1999	CLAMP, 7/16-25/32, SS, WORM, HOSE		1	\$	1.60
AB1102	VALVE, 6KPSI 1/4NPTF PM SHUTOFF		1	\$	325.00
AB110-2001	STEM, STANDARD, 65AL		1	\$	62.00
AB110-2055	HEX BOLT, 1/4-20 SEMS W/LW&FW		1	\$	3.01
AB110-2059	NARROW RECEPTALCE		1	\$	1.00
AB110-2066	GROMMET, 2.13 O.D X 1.50 I.D.		1	\$	3.35
AB110-2067	SPRING PIN 1/8X.75		1	\$	3.35
AB110-2076	SPRING, PNEUMATIC DUMP VALVE		1	\$	5.00
AB110-2082	OVERLOAD, SOLID ST 18-90A 3PH		1	\$	119.00
AB110-2083	OVERLOAD, SOLID ST 9-45A 3PH		1	\$	115.00
AB110-2084	CLOSING PLUG, RESET BUTTON		1	\$	7.73
AB110-2087	OVERLOAD, SOLID ST 9-45A 1PH		1	\$	119.00

AB110-2088	OVERLOAD,SOLID ST 18-90A 1PH		1	\$	119.00
AB110-2089	OVERLOAD,SOLID ST 5.4-27A 3PH		1	\$	67.00
AB110-2091	CYL VLV DOT 5000PSI 25E THRD		1	\$	120.00
AB110-2099	SPRING,2ND,3RD,4TH STG VALVE		1	\$	5.20
AB110-2100	SCOTT, RHT TEST SIMULATOR		1	\$	265.00
AB110-2101	PLATE,2ND,3RD,4TH STG VALVE		1	\$	5.20
AB110-2108	SPRING, DISCHG VLV 1ST STAGE		1	\$	176.00
AB110-2109	PLATE, DISCHG VLV 1ST STAGE		1	\$	123.80
AB110-2110	SPRING, INLET VALVE 1ST STAGE		1	\$	90.00
AB110-2111	PLATE, INLET VALVE 1ST STAGE		1	\$	166.81
AB110-2112	SPRING,DISCHG VALVE, 2ND STAGE		1	\$	158.00
AB110-2113	PLATE,DISCHG VALVE, 2ND STAGE		1	\$	121.80
AB110-2114	SPRING,INLET VALVE,2ND STAGE		1	\$	79.00
AB110-2118	SPRING, INLET,3RD STAGE		1	\$	62.00
AB110-2123	GASKET SET		1	\$	257.45
AB110-2128	SWITCH PLATE,BALDOR 5,7.5,10		1	\$	62.00
AB110-2160	GASKET,COPPER 4TH STAGE HEAD		1	\$	5.60
AB110-2161	O-RING 4TH STG CYL TO C/CASE		1	\$	5.60
AB110-2163	ROD, CONNECTING,4TH STAGE		1	\$	137.00
AB110-2164	PIN, WRIST 4TH STG CONNECT ROD		1	\$	20.16
AB110-2165	CLIP, WRIST PIN 4TH STAGE		1	\$	5.60
AB110-2166	PISTON, 4TH STAGE		1	\$	96.00
AB110-2167	CYLINDER, 4TH STAGE		1	\$	284.70
AB110-2169	O-RING, SEPARATOR END CAP		1	\$	5.70
AB110-2174	VALVE,MANUAL DRAIN, 1/8NPT		1	\$	85.50
AB110-2175	V-BELT, ELECTRIC EASY AIR		1	\$	12.25
AB110-2176	V-BELT,GAS POWERED EASY AIR		1	\$	12.15
AB110-2177	RA SCUBA SUPPORT		1	\$	245.00
AB110-2181	CYL LINER 4TH STG 4S25/30		1	\$	1,165.00
AB110-2198	VALVE SERVICE KIT H15T4 & 6		1	\$	1,264.00
AB110-2258	AUTO DRAIN O-RING 31, 35X3, 53		1	\$	8.75
AB110-2259	AUTO DRAIN O-RING 39, 34X2, 62		1	\$	8.30
AB110-2260	AUTO DRAIN STEEL BALL, 10MM		1	\$	11.23
AB110-2261	AUTO DRAIN SPRING, NF .030		1	\$	26.35
AB110-2262	AUTO DRAIN O-RING 9, 25X1, 78		1	\$	2.00
AB110-2263	AUTO DRAIN O-RING 29, 82X2, 62		1	\$	6.65
AB110-2264	AUTO DRAIN PISTON AB 23.008		1	\$	434.00
AB110-2269	ELBOW,PUSH-IN 1/4NPT X 1/4T		1	\$	10.75
AB110-2282	CROSS - 3/4 NPT		1	\$	33.11
AB110-2283	HEX BUSHING - 3/4 NPT STREET		1	\$	7.40
AB110-2284	ELBOW - 3/4 NPT STREET		1	\$	8.72
AB110-2285	NIPPLE - 3/4 NPT - CLOSE		1	\$	6.90
AB110-2289	CLAMP SEGMENT, 2.5" SECTION		1	\$	21.00
AB110-2294	PURIFIER COALESCER TUBE		1	\$	27.90
AB110-2295	O-RING, BASE, 2.5" SECTION		1	\$	9.00
AB110-2296	CLAMP SEGMENT, 2.25" SECTION		1	\$	21.00
AB110-2297	GUIDE BUSHING, 2.25" SECTION		1	\$	45.00
AB110-2298	MAST TUBE, 2.25" SECTION		1	\$	401.00
AB110-2299	O-RING, BASE, 2.25" SECTION		1	\$	7.80
AB110-2300-1	SBAS CONT., BASIC, ENGLISH		1	\$	1,963.00
AB110-2300-2	SBAS CONT., BASIC. W/DP ENGLIS		1	\$	2,907.00
AB110-2300-3	SBAS CONT., BASIC, W/DP,CO ENG		1	\$	2,971.00
AB110-2300-4	SBAS CONT. BASIC, W/CO,DP ENGL		1	\$	3,491.00
AB110-2301	CUP SEAL, 2.25" SECTION		1	\$	94.00
AB110-2302	CLAMP SEGMENT, 2" SECTION		1	\$	21.00
AB110-2303	GUIDE BUSHING, 2" SECTION		1	\$	45.00
AB110-2304	MAST TUBE, 2" SECTION		1	\$	371.00
AB110-2305	O-RING, BASE, 2" SECTION		1	\$	7.00
AB110-2306	CUP SEAL, 2" SECTION		1	\$	91.00
AB110-2307	CLAMP SEGMENT, 1.75" SECTION		1	\$	21.00
AB110-2308	GUIDE BUSHING, 1.75" SECTION		1	\$	42.00

AB110-2309	MAST TUBE, 1.75" SECTION		1	\$	348.00
AB110-2310	O-RING, BASE, 1.75" SECTION		1	\$	5.70
AB110-2311	CUP SEAL, 1.75" SECTION		1	\$	88.00
AB110-2312	CLAMP SEGMENT, 1.5" SECTION		1	\$	21.00
AB110-2313	GUIDE BUSHING, 1.5" SECTION		1	\$	39.00
AB110-2314	MAST TUBE, 1.5" SECTION		1	\$	330.00
AB110-2315	O-RING, BASE, 1.5" SECTION		1	\$	3.80
AB110-2316	CUP SEAL, 1.5" SECTION		1	\$	80.00
AB110-2317	CLAMP SEGMENT, 1.25" SECTION		1	\$	23.00
AB110-2318	MAST TUBE, 1.25" SECTION		1	\$	284.00
AB110-2319	CUP SEAL, 1.25" SECTION		1	\$	75.00
AB110-2320	CLAMP SCREW		1	\$	37.00
AB110-2321	2X8 SPRING PIN		1	\$	2.10
AB110-2322	THREADED BUSHING		1	\$	28.00
AB110-2323	DOG POINT GRUB SCREW		1	\$	10.00
AB110-2324	1/4 BSF THIN NUT		1	\$	2.30
AB110-2325	GUIDE BUSHING, 2.5" SECTION		1	\$	50.00
AB110-2326	MAST TUBE, 2.5" SECTION		1	\$	437.00
AB110-2327	SHOULDER HEAD SCREW		1	\$	4.20
AB110-2332	DECAL-SMART FILL AUTO CASCADE		1	\$	72.77
AB110-2346	SAE-ORB HEX HEAD PLUG		1	\$	3.60
AB110-2369	INDICATOR, MOISTURE/CO		1	\$	226.20
AB110-2370	MOISTURE/CO ELEMENT KIT		1	\$	64.00
AB110-2371	HEAD, 4TH STAGE CY. V22H-AL		1	\$	356.00
AB110-2372	SEAL, 4TH STG. DISCH. CPLNG V2		1	\$	8.10
AB110-2373	CPLNG, 4TH STG. DISCH. V22H-AL		1	\$	168.96
AB110-2374	SCREW, 3RD STG. FILTER RET.		1	\$	102.00
AB110-2375	VALVE, RELIEF, 1500 PSIG, ASME		1	\$	117.00
AB110-2376	SWITCH, LOW OIL LEVEL		1	\$	117.00
AB110-2382	O-RING, PURIFIER STEM		1	\$	2.25
AB110-2384	FILL PRESS. REG. REPAIR TOOL		1	\$	78.50
AB110-2389	MONITOR/PHASE REVERSAL & LINE		1	\$	2,388.00
AB110-2398	GAUGE, GLYCERINE FILLED, RED L		1	\$	116.00
AB110-2400-1	SBAS CONT., BASIC, ENGLISH		1	\$	1,965.00
AB110-2400-2	SBAS CONT., BASIC. W/DP ENGLIS		1	\$	2,907.00
AB110-2400-3	SBAS CONT., BASIC, W/DP,CO ENG		1	\$	2,971.00
AB110-2400-4	SBAS CONT. BASIC, W/CO,DP ENGL		1	\$	3,382.00
AB110-2449	PRESS. RELIEF VALVE, 150 PSIG		1	\$	48.00
AB110-2450	PRESS. RELIEF VALVE, 750 PSIG		1	\$	118.00
AB110-2469	VOLTMETER, 150VAC PANEL MT		1	\$	252.49
AB110-2487	V-BELT, V17 COOLING FAN DRIVE		1	\$	22.00
AB110-2490	GASKET, SHAFT END COVER, H15T6		1	\$	8.70
AB110-2491	SEAL, OIL, H15T6		1	\$	55.00
AB110-2492	KIT, BEARING/CONNECTING ROD, H		1	\$	3,813.00
AB110-2498	REG. SPRING 1/2 GREEN 6500 PSI		1	\$	11.76
AB110-2499	PISTON SWITCH 450-7500 PSI ADJ		1	\$	387.00
AB110-2502	RING TERMINAL,18-22AWG #6 STUD		1	\$	44.00
AB110-2503	CORD GRIP, 1/2"NPT, .25"-.38"		1	\$	18.00
AB110-2504	R/A CYLINDER WARNING DECAL		1	\$	15.00
AB110-2505	FUEL HOSE, 270mm F/2004 ENGINE		1	\$	92.00
AB110-2506	GASKET, COPPER 14mm F/2004 ENG		1	\$	0.50
AB110-2507	BOLT, M14 BANJO F/2004 ENGINE		1	\$	36.00
AB110-2508	BOLT, M10 BANJO F/2004 ENGINE		1	\$	33.00
AB110-2509	GASKET, COPPER 10mm F/2004 ENG		1	\$	4.40
AB110-2510	FUEL HOSE, 226mm F/2004 ENGINE		1	\$	128.00
AB110-2511	VALVE REMOVAL TOOL		1	\$	71.16
AB110-2535	LABEL, 5.5 CYLINDER COMPATIBLE		1	\$	1.30
AB110-2541	W70AL SIGHT GLASS		1	\$	39.00
AB110-2542	W70AL SIDE COVER GASKET		1	\$	11.10
AB110-2543	W70AL O-RING 1-13/16 X 3/32		1	\$	6.50
AB110-2544	W70AL GASKET O-RING KIT		1	\$	793.00

AB110-2550	INLET PIPE, 3RD STAGE V22H-AL		1	\$	94.00
AB110-2554	WASHER, INTERNAL TOOTH, M10		1	\$	0.32
AB110-2563	KEY, SPARE, LIBERTY TRAILER		1	\$	19.00
AB110-2591	MOISTURE IND SEAL KIT		1	\$	45.36
AB110-2605	GAUGE DAMPENER, 1/8 NPT		1	\$	122.40
AB110-2606	DECAL, SCOTT LOGO, 4"		1	\$	12.40
AB1102G	VALVE,6KPSI 1/4NPTF PM W/GAGE		1	\$	188.00
AB1113K	KIT,PM VALVE REPAIR 1113		1	\$	40.00
AB13-0002	DUAL PWER SLIP IN NO ENC NO TK		1	\$	92,623.30
AB13-0004	GU,CHEV. W/B,P,NR X4		1	\$	9,327.13
AB13-0012	LIB1 DES.FLTR,DES.SAND MARINES		1	\$	106,009.05
AB1300155	O-RING 52AL PURIF'R TOP&BOTTOM		1	\$	8.70
AB13-0022	10 HP SLIP-IN 460V AC, 6KPSI		1	\$	27,488.00
AB13-0023	PIERCE R/A W/CASCADE PANEL		1	\$	12,847.00
AB13-0024	PIERCE 10 H.P. 230V SLIP-IN		1	\$	26,597.00
AB13-0025	20HP,6K,4B, 65AL4,RVR,HI-LO R		1	\$	63,472.20
AB13-0026	SEQ. VALVE ASSY. W/O ISOLATION		1	\$	8,493.00
AB13-0027	R/A W/NON-ISO SEQ. VALVE ASSY		1	\$	8,435.70
AB14300	NUT, 1/2		1	\$	4.22
AB14301	SLEEVE,TUBING 1/2 FERRULE		1	\$	2.50
AB14302	NUT, 5/8		1	\$	3.16
AB14303	SLEEVE 5/8		1	\$	2.53
AB14-6004-B1	60PSI/413B BLK PLBG 1 CYL		1	\$	1,592.00
AB14-6004-B2	60PSI/413B BLK PLBG 2 CYL		1	\$	3,184.00
AB14-6004-B3	60PSI/413B BLK PLBG 3 CYL		1	\$	4,890.00
AB14-6004-B4	60PSI/413B BLK PLBG 4 CYL		1	\$	12,875.00
AB15-6600-B1	BULK PLBG 1 CYL		1	\$	2,888.12
AB15-6600-B2	BULK PLBG 2 CYL		1	\$	5,581.00
AB15-6600-B3	BULK PLBG 3 CYL		1	\$	7,915.00
AB15-6600-B4	BULK PLBG 4 CYL		1	\$	10,344.00
AB16-0018	BRACKT,TRAILER COND. COLLECTR		1	\$	181.00
AB16-0031	COVER WELDMENT		1	\$	1,284.00
AB16-0032	TOP STORAGE ASSEMBLY		1	\$	9,782.00
AB16-0070-4P	ASSY PANEL DUAL PRESS REG LE4		1	\$	3,726.45
AB16-0072	ASSY,LOW PRESS WALL MOUNT		1	\$	1,433.00
AB16-0073	ASSY,HIGH PRESS WALL MOUNT		1	\$	1,465.00
AB16-0106	WELDMENT,INTAKE TUBE		1	\$	42.00
AB16-0130	SEQUENCE VALVE ASSY		1	\$	8,944.00
AB16-0160	BLOCK & COUPLINS ASSY		1	\$	161.18
AB16-0161	ADJ VALVE BLOCK ASSY		1	\$	455.00
AB16-0163	TOGGLE VALVE ASS'Y, REVOLVE AI		1	\$	433.00
AB16-0188-20	HOSE ASSY 3/16,1/4 JIC 20" 7K		1	\$	79.00
AB16-0188-240	HOSE ASSY 3/16,1/4 JIC X240 7K		1	\$	330.00
AB16-0188-300	HOSE ASSY 3/16,1/4 JIC X300 7K		1	\$	271.00
AB16-0188-33	HOSE ASSY 3/16,1/4 JIC X 33 7K		1	\$	84.00
AB16-0188-80	HOSE ASSY 3/16,1/4 JIC X 80 7K		1	\$	148.00
AB16-0188-93	HOSE ASSY 3/16,1/4 JIC X 93 7K		1	\$	160.00
AB16-0198	BASE, FILL ADAPTER		1	\$	446.00
AB16-0199	SCUBA FILL ADAPTER		1	\$	132.00
AB16-0202	CGA 346/7 FILL ADPT W/ SEALOFF		1	\$	139.00
AB16-0203	DIN SEALOFF ASSY		1	\$	28.91
AB16-0204	DIN ADAPTER WITH SEALOFF		1	\$	206.00
AB16-0216	60 HZ TENSIONER MOUNTING KI		1	\$	1,518.00
AB16-0221	ASSY, STORAGE REFILL		1	\$	590.00
AB16-0282	10/230/60/1 ASSY ENCL		1	\$	2,892.00
AB16-0288	KIT-SPARE TIRE RETRO-FIT		1	\$	351.00
AB16-0295	STAND ASSY- HA COMP STAND		1	\$	0.11
AB16-0299	ASSEMBLY,PURGE VALVE		1	\$	179.00
AB16-0310	STD RA BASE		1	\$	704.00
AB16-0330	X4-KIT-PNEU-STD.-SLANT		1	\$	866.00
AB16-0331	X4-KIT-PNEU-WALL MNT		1	\$	1,029.00

AB16-0383	HOOD ASSY, GUARD-SA COMP. STAND		1	\$	175.28
AB16-0393	1 CYL KIT, PLBG VERT CSCD ASME		1	\$	3,104.42
AB16-0420	TIRE MOUNT, SPARE, TRAILER		1	\$	188.00
AB16-0441	MOTOR MNT-SA COMP STAND		1	\$	171.33
AB16-0454	PANEL, ASSY, 6KPSI REEL, LIB II		1	\$	1,300.00
AB16-0464	PURIF 20SCFM 6KPSI GR E WO/MI		1	\$	4,194.00
AB16-0472	SCUBA ADPTR FOR R/A W/DIN		1	\$	409.00
AB16-0473	SCUBA ADPTR GUARD. W/DIN		1	\$	234.00
AB16-0476	TIRE KIT LIB1		1	\$	862.00
AB16-0477	TIRE KIT LIB2		1	\$	758.00
AB16-0478	SCUBA ADPTR FOR GUARD. W/CGA		1	\$	264.00
AB16-0486	SEQUENCE VALVE ASSEMBLY		1	\$	9,100.00
AB16-0514	LE5000 WALL MT RETRO-FIT CONTR		1	\$	5,422.00
AB16-0532	REG. ASSY. CAL, GAS 1.5LPM		1	\$	223.00
AB16-0533	CALIBRATION KIT X4		1	\$	342.00
AB16-0541	LE5000 WALL MT RETRO-FIT KIT		1	\$	6,404.00
AB16-0542	LE4000 WALL MT RETRO-FIT KIT		1	\$	3,420.00
AB16-0543	LE5000 STA'NARY RETRO-FIT KIT		1	\$	6,535.00
AB16-0544	LE4000 STA'NARY RETRO-FIT KIT		1	\$	3,104.00
AB16-0552	UPGRADE KIT, COLTRI PUR FILTER		1	\$	1,681.00
AB16-0561	Trunnion Valve		1	\$	866.00
AB16-0565	RA ASSY W/O STAND, RED		1	\$	8,442.00
AB16-0580	DOT CYL VLV & CAP 6000PSI 10YR		1	\$	1,592.00
AB16-0607	ASSEMBLY, FILTER ADAPTER		1	\$	58.00
AB16-0624	KIT, SCUBA, CGA-REV/AIR		1	\$	404.00
AB16-0625	KIT, SCUBA, DIN-REV/AIR		1	\$	401.00
AB16-0626	KIT, RA FILTER		1	\$	22.00
AB16-0632	PURIFIER MNT ADAPTER-WELDMENT		1	\$	260.00
AB16-0651	ASSY - AUTO CASCADE		1	\$	4,439.00
AB16-0656	PURIFIER TUBE ASSEMBLY		1	\$	1,229.00
AB16-0682	ASSY - AUTO CASCADE		1	\$	4,456.00
AB16-0683	KIT, OVERLOAD REPLACEMENT		1	\$	230.25
AB16-0684	KIT, OVERLOAD REPLACEMENT		1	\$	239.70
AB16-0685	KIT, OVERLOAD REPLACEMENT		1	\$	289.00
AB16-0686	KIT, OVERLOAD REPLACEMENT		1	\$	289.00
AB16-0687	KIT, OVERLOAD REPLACEMENT		1	\$	289.00
AB16-0688	KIT, OVERLOAD REPLACEMENT		1	\$	230.25
AB16-0689	KIT, COLTRI, PURIFIER, RETRO-FIT		1	\$	1,519.00
AB16-0701	ASSY, AUTO 4 BANK CASCADE MOBI		1	\$	12,290.00
AB16-0710	SLIP IN, 10 H.P. HAM. 208V		1	\$	26,181.00
AB16-0711	SLIP IN, 10 H.P. HAM. 230V		1	\$	26,181.00
AB16-0714	SLIP IN, 20 H.P. ING. 230V		1	\$	35,062.00
AB16-0724	SLIP IN, 15 H.P. HAM. 208V		1	\$	33,043.00
AB16-0769	20 HP ING COMPR. W/ MOB. RA/ A		1	\$	41,389.00
AB16-0793	15 IR 208 COMP. MOB. RA 4 AUTO		1	\$	54,353.00
AB16-0807	5.5 REVOLVEAIR CONVERSION KIT		1	\$	121.00
AB16-0808	5.5 COMPRESSOR START/STOP CONV		1	\$	450.00
AB16-0861	RETROFIT, SPRING TENSIONER, LIB		1	\$	364.00
AB16-0871	LIB LE5 - X4 RETRO-FIT KIT		1	\$	6,850.00
AB16-0873	FILL ADAPTER, CGA X FEM. DIN		1	\$	130.00
AB16391	SEAT, DELIVERY VALVE-24		1	\$	269.00
AB16411	SPRING, DEL VALVE-4-7-24		1	\$	17.00
AB16413	PLATE, DEL VALVE-4-7-24		1	\$	65.00
AB16414	PLATE, SUCTION VALVE-24		1	\$	37.00
AB16415	SPRING SUCTION VALVE-7-24		1	\$	20.00
AB17817	FILTER, POROSINT 40 MICRON BRON		1	\$	11.70
AB17969	SET, BONDED SEAL 1/4BSP		1	\$	9.40
AB210008	RING, BACKUP TEFLON 50AL		1	\$	4.20
AB210012	PLUG, BURST DISC 60/50AL		1	\$	16.00
AB210013	WASHER, BURST DISC SEAL NYLON Z		1	\$	0.30
AB210014	DISC, BURST 10000PSI		1	\$	1.40

AB210014-5	DISC,BURST 5KPSI 50AL 60AL		1	\$	6.50
AB22445	ELEMENT,INTAKE 4S7 OE		1	\$	82.00
AB22446	ELEMENT,FILTER INTAKE		1	\$	139.00
AB230600	PLUG,50/60AL DRAIN VALVE PORT		1	\$	24.00
AB230601	KIT,REPAIR 1102 SHUTOFF VALVE		1	\$	98.00
AB230602	KIT,VALVE O-RING 50AL 60AL 110		1	\$	83.00
AB230604	SEAT,BRS W/TEFLON INSERT		1	\$	19.85
AB230605	STEM,SHUTOFF VALVE SS 1102		1	\$	18.97
AB230606	NUT,SS SHUTOFF VALVE SEAL		1	\$	20.76
AB230607	KNOB,HANDWHEEL ABI VALVE		1	\$	11.50
AB230609	NUT,STEM BRS CHROME PLATED LOC		1	\$	9.03
AB230612	SPRING,SOV KNOB 1102 ASSY		1	\$	16.00
AB230710	KIT,BURST DISC 10000PSI 60AL 5		1	\$	50.00
AB230842	KIT,O-RING 42AL FILTER		1	\$	37.00
AB230860	KIT,O-RING SHORT STEM 62AL 60A		1	\$	34.00
AB230861	KIT,O-RING MED STEM 60AL & LON		1	\$	34.00
AB23182	VALVE, RELIEF 650PSI -4 2ND ST		1	\$	253.00
AB23185	VALVE,SAFETY 3RD STG 1200PSI		1	\$	230.00
AB23497	SCREW, RETAINING		1	\$	68.00
AB23498	SPRING,3RD STG POROSINT FILTER		1	\$	12.80
AB235815	LOCKWASHER,1/4 STEEL ZINC		1	\$	0.10
AB23700	VALVE,SAFETY 1400PSI		1	\$	217.00
AB23985	WASHER,BONDED		1	\$	6.50
AB241507B	DISC,BURST 4800PSI 42AL		1	\$	4.40
AB241507K8	KIT,42MS 42AL BURST DISC REPAI		1	\$	45.00
AB241507KS	KIT,42MS REPLACE O-RING SEAL		1	\$	39.00
AB2426012	ASSY,SCUBA CLAMP X4AN MALE STD		1	\$	145.00
AB243801S	BODY,FILL ADAPTER 6SAEX1/8NPTF		1	\$	36.00
AB243802	NUT,PANEL MTG FILLER ADAPTER		1	\$	13.80
AB2494	ASSY,DUMP BLOCK ALUMINUM VALVE		1	\$	166.00
AB2494K	KIT, REPAIR DUMP VALVE		1	\$	45.00
AB25012	BLADE,FAN FOR 4S12/4S17		1	\$	107.00
AB25017	GASKET,COVER 4S-10		1	\$	7.00
AB25019	GASKET,BEARING HOUSING 4S-10		1	\$	6.40
AB25031	GASKET,CYLINDER HEAD 4S-10-12		1	\$	12.80
AB25036	ASSY,SUCTION VALVE 2ND STAGE		1	\$	301.00
AB25037	ASSY,DELIVERY VALVE 2ND STAGE		1	\$	609.00
AB25045	SEAL,DELIVERY VALVE SEAT		1	\$	134.00
AB25047	O-RING,4TH STAGE-10		1	\$	8.10
AB25048	O-RING,4TH STAGE-10		1	\$	6.80
AB25052	RING,COMPRESSION 3RD STG 3S-10		1	\$	200.00
AB25061	GASKET,CYLINDER BASE 4S-10		1	\$	6.62
AB25064	O-RING,-10-12		1	\$	11.45
AB25069	O-RING,2ND ST VALVE SUCTION &		1	\$	7.63
AB25117	SEAL,O-RING 15MM-10		1	\$	8.80
AB25121	RING,COMPRESSION 1ST STG-12		1	\$	61.58
AB25307	VALVE,SUCTION DELIVERY 14C-10		1	\$	315.00
AB25312	RING, COMPRESSION 3RD STG -10		1	\$	82.93
AB25313	RING,COMPRESSION 3RD STAGE		1	\$	61.47
AB25316	CIRCLIP,15MM 3RD STAGE PISTON		1	\$	7.80
AB25320	RING, PISTON 4TH STAGE -10		1	\$	151.00
AB25523	BLADE, FAN- 4S25		1	\$	83.00
AB25528	GASKET,CRANKCASE-25 END COVER		1	\$	25.66
AB25543	GASKET,1ST STG-25-30 UPPER		1	\$	24.00
AB25544	ASSY, VALVE REED-25		1	\$	951.00
AB25545	GASKET,1ST STG-25-30 LOWER		1	\$	21.00
AB25547	WASHER,VALVE SEAT-25		1	\$	24.00
AB25548	VALVE, SUCTION 2ND STAGE-25		1	\$	877.00
AB25549	VALVE, DELIVERY 2ND STAGE-25		1	\$	528.00
AB25555	RING, COMPRESSION 112MM		1	\$	141.72
AB25556	RING, COMP MAJOR DIA 4S25		1	\$	145.00

AB25557	RING, OIL CONTROL		1	\$	133.00
AB25564	VALVE,SUCTION 3RD STAGE-25		1	\$	926.00
AB25565	VALVE,DELIVERY 3RD STAGE-25		1	\$	926.00
AB25566	WASHER,VALVE SEAT,3RD STAGE		1	\$	50.90
AB25569	RING, COMPRESSION 83MM		1	\$	180.74
AB25570	RING, COMPRESSION 83MM		1	\$	157.68
AB25571	RING, COMPRESSION 79.38MM		1	\$	77.63
AB25576	PISTON, HP		1	\$	915.00
AB25579	GASKET,LP CYL TO CRANKCASE 4S2		1	\$	8.90
AB25581	WASHER,SEALING-25		1	\$	3.63
AB25584	LOW PRESS PISTON		1	\$	1,931.00
AB2595C	BASE,62AL PURIFIER BARE		1	\$	391.00
AB2595E2	HOUSING, 62AL PURIFIER ALUM		1	\$	704.00
AB2595E2C	CAP,62AL PURIFIED ALUM		1	\$	270.00
AB2723M	LABEL,PURIFICATION FILTERS STD		1	\$	6.00
AB280005	O-RING,60AL VALVE SEAL 1102		1	\$	2.50
AB280006	O-RING,50AL FILTER		1	\$	4.00
AB280007	O-RING,50AL FILTER STEM		1	\$	0.70
AB280010	O-RING,42AL FILTER VITON -011		1	\$	0.50
AB280013	O-RING,VITON DUMP BLOCK		1	\$	1.00
AB280015	O-RING,2-136 TOP OF 42AL BASE		1	\$	2.70
AB280020	O-RING,VITON		1	\$	1.00
AB280022A	O-RING,FILL ADAPTER 346/347 TI		1	\$	7.90
AB280024T	O-RING,-232 TEFLON 2-3/4ID X1/		1	\$	6.90
AB280027	O-RING,60AL BASE		1	\$	3.80
AB280057	ORING -239 VITON		1	\$	5.90
AB280059T	O-RING,-226 TEFLON 2ID X1/8		1	\$	5.50
AB280061T	O-RING,-228 TEFLON 2-1/4ID X1/		1	\$	10.00
AB280065	ORING VITON .468ID .078W		1	\$	1.40
AB280066T	O-RING,-230 TEFLON 2-1/2ID X1/		1	\$	7.80
AB2801C	WASHER,TEFLON		1	\$	13.80
AB280207	VALVE,RELIEF 150PSI 1/4NPT ASM		1	\$	29.00
AB280217	VALVE,30PSI RELIEF 1/8NPT SOFT		1	\$	29.00
AB280239	VALVE,RELIEF ADJ 6KPSI ALUM		1	\$	141.00
AB280239-48	VALVE,RELIEF PRE-SET@4800PSI		1	\$	147.00
AB280239H	VALVE,RELIEF ADJ 6.3KPSI ALUM		1	\$	184.00
AB280242	FUSE, FLOW 6K PSI 1/4NPT MALE		1	\$	104.00
AB280256	VALVE,RELIEF 50-200PSI 1/4NPTM		1	\$	41.50
AB280261	VALVE,135PSI RELIEF ASME 1/4NP		1	\$	80.00
AB280264	VALVE,5500PSI ASME 1/4NPT RELI		1	\$	1,029.00
AB280265	VALVE,RELIEF 6500PSIASME CODED		1	\$	623.00
AB280432	GAUGE,600PSI 2-1/2 SS GF PM		1	\$	179.00
AB280446	GAUGE,6000PSI 2-1/2 SS GF PM		1	\$	283.00
AB280470	GAUGE,200PSI 2" 1/4NPT CB		1	\$	28.00
AB280479	GAUGE,160PSI 1/8NPT MINI		1	\$	36.78
AB280504	VALVE,BACKPRESS 6KPSI 1/4NPT F		1	\$	109.00
AB280507	VALVE,BACKPRESS 1/2NPT 6KPSI A		1	\$	191.00
AB280507K	KIT BACK PRESS 1/2NPT REPAIR		1	\$	88.00
AB280610	VALVE,CGA702 DOT CYL 6KPSI		1	\$	200.00
AB280610A	DISC,6750PSI DOT BURST		1	\$	20.00
AB280724	VALVE,1/2NPTM XFEM MINI BRS BA		1	\$	32.00
AB280736	VALVE,6KPSI 3WAY PM TRUNNION B		1	\$	752.00
AB280736K	KIT,REPAIR F/280736 VALVE		1	\$	281.60
AB280738	VALVE,1/8NPTF STL 5KPSI THROTT		1	\$	89.00
AB280937	REGULATOR, 6KPSI IN 5KPSI OUT		1	\$	523.00
AB280937K	KIT, REGULATOR REPAIR		1	\$	151.00
AB280937M	BRACKET,MOUNT FOR 280937 REGUL		1	\$	68.00
AB280940	REGULATOR,6KPSI X 400PSIMAX OU		1	\$	523.00
AB281009	REGUL.,LP MINI 1/8 NPT L/GAGE		1	\$	67.00
AB281009A	NUT,MINI REG MOUNTING		1	\$	9.80
AB281032	LUBRICATOR,MINI 1/8NPT 20CFM		1	\$	60.00



AB281205	ELEMENT, INTAKE FILTER -4 -5 P		1	\$	69.00
AB281206	ELEMENT,INTAKE FLTR REPLACEMEN		1	\$	62.00
AB281207	SILENCER,RECLASSIFIER 1NPT		1	\$	209.00
AB281219A	ELEMENT,FILTER COALESCER		1	\$	87.00
AB281247	FILTER,1-1/4NPT INTK SILENCER		1	\$	92.00
AB281251	ELEMENT,COALESCER 3SS PURIFICA		1	\$	37.00
AB281251-1	ELEMENT KIT		1	\$	74.00
AB281271A	ELEMENT,PREFILTER COALESCER 10		4	\$	47.00
AB281273	ELEMENT,INTAKE INLET		1	\$	28.00
AB281277	ELEMENT,FILTER PLEATED		1	\$	61.00
AB281293	ASSY,ELEMENT,COALESCER FULL 60		1	\$	137.00
AB281297	SILENCER,1/4NPTM MINI AIR MUFF		1	\$	11.50
AB281505	TEE,1/8NPTF BRS PIPE		1	\$	7.80
AB281507	TEE,BRANCH 1/8 NPT STL		1	\$	21.00
AB281508	TEE,1/4NPT STREET STL		1	\$	16.00
AB281509	TEE,1/4NPTF STL HP		1	\$	14.00
AB281510	TEE,1/4NPT BRANCH STL		1	\$	12.92
AB281512	TEE,STREET 1/8NPT STL		1	\$	13.00
AB281608	REDUCER,1/4NPTF X 1/8NPTM STL		1	\$	6.80
AB281609	REDUCER,1/4NPTM X1/8NPTF STL		1	\$	4.00
AB281616	REDUCER,1/2X1/4NPT HP STL		1	\$	8.75
AB281619	ADAPTER,3/8 TUBE X 1/4MNPT ST		1	\$	17.00
AB281624	REDUCER,1NPTM X1/4NPTF STL HP		1	\$	31.00
AB281715	CONNECTOR,4ANX1/4NPTM W/O NUT		1	\$	3.70
AB281716	CONNECTOR,4MS X1/4MNPT STL BST		1	\$	9.40
AB281718	CONNECTOR,6MS X1/4NPTM STL		1	\$	8.90
AB281721	CONNECTOR,4MS X1/8MNPT STR STL		1	\$	7.70
AB281761	CONNECTOR,2MS X1/8NPTM STL		1	\$	8.50
AB281762	CONNECTOR,2MS X1/4NPT STL		1	\$	14.00
AB281770	CONNECTOR,2MS X 1/16NPTM SS		1	\$	24.00
AB281775	ELBOW,4MSX1/4NPTM 45DEG SS		1	\$	50.00
AB281778	FERRULE 6MM EO 250 BAR STL		1	\$	0.20
AB281785	CONNECTOR,4AN X 6SAE O-RING		1	\$	5.40
AB281789	CONNECTOR,5MS X1/4NPTM STL		1	\$	9.00
AB281807	CONNECTOR,4ANX1/4NPTF W/O NUT		1	\$	7.50
AB281808	CONNECTOR,4MS X1/4FNPT BSTL		1	\$	10.80
AB281829	CONNECTOR,2MSX 1/4NPTF SS		1	\$	31.00
AB281907	PLUG,1/8NPT SOCKET STL		1	\$	3.00
AB281908	PLUG,1/4NPT SOCKET STL PIPE		1	\$	3.90
AB281914	PLUG,1/4NPT HEX HD STL		1	\$	1.90
AB281915	PLUG,1/8NPT HEX STL PIPE		1	\$	1.60
AB281929	PLUG,6SAE STR THRD O-RING HEX		1	\$	21.00
AB282003	CROSS, 1/4FNPT STL		1	\$	24.90
AB282006	CROSS,1/8FNPT STL		1	\$	40.00
AB282104	OIL, 1 GALLON, COMPRESSOR		1	\$	126.00
AB282130	OIL,15W-40 MOTOR, DIESEL		1	\$	55.00
AB282203	SWITCH,LOW OIL SAFETY W/GAUGE		1	\$	230.00
AB282412	FERRULE,1/8 SS PARKER FERULOK		1	\$	7.10
AB282420	FERRULE,1/8 CPI SS TUBE		1	\$	7.00
AB282511	NUT 1/8 2MS FERULOK STL TUBING		1	\$	2.50
AB282902	RING,BACK UP 42AL BASE TOP		1	\$	2.00
AB282903	RING,BACK UP 60AL SERIES		1	\$	1.70
AB282908	RING, BACKUP TEFLON-333		1	\$	3.50
AB283041	SWITCH,60PSI 1/8NPT NO/NC PRES		1	\$	109.00
AB283049	BREAKER,6A AUTO RESET W/MT CIR		1	\$	15.00
AB283109	NIPPLE,HEX 1/4 NPT S		1	\$	3.70
AB283110	NIPPLE,HEX 1/8NPT STL HP		1	\$	3.10
AB283111	NIPPLE,1/4 X 1/8 HEX STL		1	\$	5.00
AB283120	REDUCER 3/8 X 1/8 STL PIPE HP		1	\$	6.60
AB283307	TUBING,1/4 POLY FLO		1	\$	1.40
AB283308	ELBOW,1/4 POLY X1/8NPTM BRS		1	\$	5.90

AB283330	TEE,1/4 POLY X1/8NPTM BRS STRE		1	\$	9.45
AB283334	ELBOW,1/8TU X 10-32ADJ SUR LOK		1	\$	12.80
AB283411	V-BELT,C85 89" OD MATCHED		1	\$	86.00
AB283443	V-BELT,A71 73 IN OD		1	\$	23.30
AB283488	V-BELT,A72 74IN OD		1	\$	22.00
AB2834A52	V-BELT,A52 54" OD		1	\$	15.40
AB2834A55	V-BELT,A55 57IN OD		1	\$	19.00
AB2834A74	V-BELT, A74		1	\$	24.00
AB2834C81	V-BELT,C81 85 IN OD		1	\$	87.00
AB283675-1	COUPLING, FLEX TOOTH MODIFIED		1	\$	100.00
AB283810	CLUTCH,AIRW/2B SHEAVE INTEGRAL		1	\$	1,857.00
AB283811	KIT, AIR SUPPLY FOR 4UC CLUTCH		1	\$	642.60
AB284124	ASSY,INDICATOR HP CO/H2O BODY		1	\$	145.00
AB284130	VOLTMETER,150VAC PANEL MT1-1/2		1	\$	245.00
AB284202	GROMMET,3/16ID 5/16HOLE 1/8GRO		1	\$	0.40
AB284213	CABLE,6/4 SO BLACK		1	\$	10.20
AB284232	HOLDER,FUSE PANEL MT 250V 15A		1	\$	9.70
AB284263	GRIP, .75-.875 90EL ALU 1NPT		1	\$	74.00
AB284270	RECEPTACLE,15A 125V DUPLEX		1	\$	22.72
AB284290	TERMINAL,RING 12-10 X #10 UNIN		1	\$	0.76
AB284306	ASSY,CGA346/347 FEM X 1/4 NPTM		1	\$	65.00
AB284306A	ADAPTER,CGA346/347 FEMX4JIC ML		1	\$	78.00
AB284309	ADAPTER,CGA346 MALE X1/4NPTM B		1	\$	14.90
AB284318	ASSY,SCUBA CLAMPXCGA W/18"HOSE		1	\$	233.00
AB284321A	ADAPTER,CGA347X1/4NPTF BRS MINI		1	\$	38.00
AB284321B	ADAPTER,CGA347 MALEX1/4NPTM SS		1	\$	41.00
AB284419	ASSY,HOSE 4FT 6KPSI W/4AN FE		1	\$	121.00
AB284426	ASSY,6FTHP HOSE FSWVL6KPSI3/16		1	\$	137.00
AB284443	HOSE,2"INTAKE SMOOTH BORE RIBB		1	\$	8.20
AB284445	ASSY,25FT 6KPSI 3/16 W/4JIC		1	\$	365.00
AB284446	ASSY,10FT 6KPSI 4JICF ENDSHOSE		1	\$	187.00
AB284452	HOSE,250PSI 3/4 BLCK GEN PURPO		1	\$	8.00
AB284453	BARB,3/4 HOSE X3/4NPTM BRS		1	\$	11.70
AB284454	BARB,3/4 HOSE X1/2NPTM BRS		1	\$	10.10
AB284455	ASSY,1FT HP HOSE FSWVL 6KPSI 3		1	\$	41.85
AB284461	COUPLING,4JIC FEM SWIV X3/16HO		1	\$	11.70
AB284478	HOSE,7KPSI 3/16 ID PARFLEX		1	\$	12.80
AB284612	ELBOW,4MS X1/4NPT MALE STL		1	\$	22.00
AB284613	ELBOW,6MS X1/4MNPT BSTL		1	\$	20.00
AB284617	ELBOW,4MS X1/8MNPT BSTL		1	\$	17.00
AB284622	ELBOW,2MS X 1/8NPT SS		1	\$	34.00
AB284636	ELBOW,2MS X1/8NPT STL		1	\$	28.00
AB284637	ELBOW,2MSX1/4NPTM STL CPI		1	\$	37.00
AB284704	CLAMP,3/8" OD RUBBER CUSHIONED		1	\$	0.75
AB284705	CLAMP,MS21919WDG10 CUSHIONED		1	\$	22.00
AB284709	CLAMP,#8 CUSHIONED 1/2 TUBING		1	\$	0.90
AB284710	CLAMP,SS WORM 1/4-5/8 MAX		1	\$	3.00
AB284712	CLAMP,MS21919WDG5 CUSHIONED		1	\$	2.90
AB284714	CLAMP,#16 HT SILICONE CUSHND H		1	\$	1.30
AB284715	CLAMP,SS WORM 2-1/2 MAX		1	\$	8.60
AB284736	CLAMP,HD 1X1-3/4 SS WORM		1	\$	5.00
AB284738	CLAMP,5/8 NOM.PLASTIC SNAPPER		1	\$	1.80
AB284804	CONNECTOR,BLKHD 4ANX4MS STL		1	\$	40.00
AB284808	UNION,4ANX4AN STL BLKHD		1	\$	12.70
AB284818	UNION,4AN X 4AN SS		1	\$	43.00
AB284837	CONNECTOR,4AN X1/8NPTF BLKHD S		1	\$	17.00
AB285015	VALVE,SOLENOID 3WAY NC12V 250P		1	\$	97.00
AB285016	VALVE,SOLENOID 3WAY NC 230V		1	\$	94.00
AB285041A	COIL 230V ASCO SERIES		1	\$	112.00
AB285205	ELBOW,STREET 1/4NPT STL		1	\$	10.90
AB285207	ELBOW,STREET 1/8NPT STL		1	\$	9.50

AB285210	ELBOW,45 STREET 1/4NPT STL		1	\$	7.50
AB285214	ELBOW,MALE 1/8NPT STL		1	\$	9.20
AB285304	TEE,4MS X 1/4NPTM RUN STREET S		1	\$	28.00
AB285311	TEE 6MSX6MSX1/4 NPTF STL RUN		1	\$	23.00
AB285322	TEE,4ANX1/4NPTM BRANCH STL 4JI		1	\$	19.50
AB285324	TEE,4ANX4ANFEM SWIVEL STL RUN		1	\$	17.00
AB285427	ASSY,SENSOR CELL CO LE1010 LE1		1	\$	1,581.00
AB285438	ASSY,SENSOR CELL CO LE5000		1	\$	824.00
AB285557	BULB,QUARTZ 300W 120V		1	\$	18.00
AB285574	MAST,15FT AIR LIFTLIGHT TOWER		1	\$	1,432.00
AB285574K	KIT,REBUILD F/285574 AIR MAST		1	\$	596.00
AB285627	TRANSFORMER,440VX115/230 100VA		1	\$	206.00
AB285629	TRANSFORMER,380V X 220V 100VA		1	\$	315.00
AB285709	METER,HOUR MINI 4-40VDC		1	\$	94.00
AB285714	METER,HOUR 240V MINI HOBBS		1	\$	128.00
AB286110	ELBOW,4AN X1/4NPTM STL 4JIC		1	\$	8.12
AB286111	ELBOW,4AN X1/4NPTF STL 4JIC		1	\$	13.23
AB286120	ELBOW,4AN SWIVEL NUT MALEXFEM		1	\$	14.00
AB286423	RECEPTACLE, CLIP ON		1	\$	4.30
AB286431E	END,5/16 8MM METAL GAS SPRING		1	\$	6.10
AB28643560	SPRING,GAS 60LB 7.8IN STROKE		1	\$	56.00
AB28643580	SPRING,GAS 80LB 5.47 IN STROKE		1	\$	50.00
AB28643590	SPRING,GAS 90# 7.8STRK 18.2QAL		1	\$	46.00
AB286435C	SPRING,90LB 5" STROKE GAS		1	\$	49.00
AB286435MT	MOUNT,5/16 BALL STUD F/GAS SPR		1	\$	4.60
AB286435R	CLIP,RETAINER FOR GAS SPRING		1	\$	1.20
AB286445	LOCK, MECHANISIM		1	\$	70.00
AB286453S	HINGE,2"OPEN 1/8 PIN 304SS 96"		1	\$	2.50
AB286454	DETENT,1-8 THRD		1	\$	48.00
AB286456	LOCK,LEVER W/INTERNAL 1WAY CAM		1	\$	329.00
AB286456H	ROD,SPARE FOR 286456		1	\$	47.15
AB286456K	KNOB,F/HANDLE REVOLVEAIR		1	\$	33.32
AB286459	SPRING,40LB 2.36" STROKE GAS		1	\$	37.00
AB286471	HANDLE,HD LOCKING ZINC 1/2SHAF		1	\$	110.00
AB286503	COUPLING,1/4NPT STL HP		1	\$	5.90
AB286831	BUSHING, 1-1/8 BORE TL 1610		1	\$	41.00
AB286862	BUSHING,2517 X 1-5/8 TL		1	\$	66.00
AB286876	BUSHING,H 1-3/8		1	\$	32.00
AB286884	BUSHING,D 1-1/8		1	\$	9.50
AB286904	ELBOW,MALE 1/4MNPT STL		1	\$	9.80
AB286905	ELBOW,1/4 FEM STL HP		1	\$	11.70
AB287001	TUBING, 1/4 X .049 304SS A269		1	\$	10.70
AB287007	TUBING, 1/8 X .028 304SS A269		1	\$	10.10
AB287008	TUBING, 3/8 X .065 304SS A269		1	\$	19.00
AB287121	GAUGE,FUEL DIRECT READ TOPMNT		1	\$	203.00
AB287426	BOX,2 GANG 3EA 1/2 OUTLETS		1	\$	21.63
AB287441E	ELBOW,3/8 BX FLEX X1/2NPT 90DE		1	\$	7.70
AB287525	CONNECTOR,7POLE TRAILER END		1	\$	40.00
AB287530	HOSE,FUEL 1/4ID HEAVY DUTY		1	\$	4.00
AB287536	CONNECTOR,7POLE VEHICLE END		1	\$	40.00
AB287541	RELAY,DPDT 12VDC W78RCSX-7 P&B		1	\$	109.00
AB287548	COVER,2GANG OUTDOOR OUTLET BOX		1	\$	68.00
AB287609	MOTOR,5HP3450RPM 208/460V3P182		1	\$	720.00
AB287610	MOTOR,15HP 1760RPM 230/460VODP		1	\$	1,469.00
AB287637	MOTOR,10HP 1PH 3450RPM 208-230		1	\$	1,645.00
AB287644	MOTOR,10HP 3PH 230/460V 3450R		1	\$	1,623.00
AB287645	MOTOR,20HP 1760R 208/460V ODP		1	\$	1,806.00
AB287650	MOTOR, 7.5HP 1PH 3450 230/460		1	\$	1,934.22
AB287703	MOLDING,1/4 VINYL BLACK		1	\$	2.60
AB287713	MOLDING,1/2X1/2 BLACK VINYL		1	\$	3.40
AB287903	ELBOW,45 4MSX1/4NPTM STL		1	\$	17.00

AB288010	MOUNT,NEOPRENE BLUE		1	\$	48.00
AB288015	MOUNT,NEOPRENE WHITE SHOCK		1	\$	83.00
AB288018	MOUNT,280# SNGL DFCL 3/8-16 GR		1	\$	36.00
AB288019	MOUNT,8-32 5/8W 1/2H MALE X FE		1	\$	6.50
AB288101	ELBOW,45D 4AN X1/8NPTM STL 4JI		1	\$	10.00
AB288215	TUBING,3/8ID X5/8OD PLASTIC RE		1	\$	10.00
AB288231	ELBOW,1/8NPTM X 3/8 BARB BRS		1	\$	9.60
AB288233	COUPLING,HI-FLO QD 1/2NPTM THR		1	\$	19.00
AB288443	BAGGING,5-1/2X500FT POLYMYLAR		1	\$	1.30
AB288459	CONTAINER,2-1/2G PLASTIC W/LID		1	\$	65.00
AB288705	TUBING,1/8 NYLON		1	\$	0.60
AB288811	CASTER,8X2.5GRAY POLY 1100LB S		1	\$	250.00
AB290060	ASSY,346/347CGAX6SAE MALE FILL		1	\$	82.00
AB290329	HOSE REEL 6KPSI 250FT LIB II		1	\$	5,873.70
AB290330	OPT,LP HOSE REEL 150FT 300PSI		1	\$	3,448.00
AB290394	ASSY,SCUBA X RVLVR W/SUPP RACK		1	\$	390.00
AB294203	CORD,16/3 SO		1	\$	1.50
AB294222	LOCKNUT,1NPT CONDUIT FITTING		1	\$	0.70
AB294238	LOOM,3/8 CONVOLUTED PLASTIC		1	\$	1.00
AB294271	CORD,6/3 SO POWER		1	\$	9.10
AB294275	GRIP,CORD .63-.75 3/4NPT EL ST		1	\$	49.35
AB294286	CONNECTOR,1/2 SUPER FLEX CONDU		1	\$	5.36
AB294290	CONDUIT,3/8 SUPER FLEX BLK PVC		1	\$	3.80
AB294292	ELBOW,3/8 SUP FLEX BLK CONDUIT		1	\$	8.10
AB296808	SHEAVE,2A,4.2,4.45 OD "A"ONLY		1	\$	53.27
AB299317	TERMINAL,RING #8 5/16 INSUL		1	\$	1.40
AB299609	DISCONNECT,SOCKET 1/4NPTM W/LO		1	\$	45.00
AB299639	BARB,1/2HOSE X 1/2NPTM 90D BRS		1	\$	9.83
AB299703	PLUG,1/2 SQ HD BLK IRON		1	\$	1.10
AB299727	ELBOW,1-1/4NPT STREET BLK PIPE		1	\$	16.00
AB299734	NIPPLE,1-1/4 CLOSE BLK PIPE		1	\$	5.80
AB299873	REDUCER,3/8NPTM X 1/4NPTF BRS		1	\$	3.60
AB299874	REDUCER,1/2NPTM X1/4NPTF BRS		1	\$	5.30
AB300007	NUT,1/4-20 HEX ZINC PLATED		1	\$	0.20
AB300031	SCREW,8-32 X3/4 PHIL PAN ZINC		1	\$	0.20
AB300034	LOCKWASHER,5/16 SPLIT STL ZINC		1	\$	0.50
AB300042	BOLT,5/16-18X1-1/2 HX GRD5		1	\$	0.35
AB300047	LOCKWASHER,1/4 SAE SPLIT SS		1	\$	0.20
AB300050	ROD, THREADED 1/2-13 X 3FT ZIN		1	\$	20.00
AB300108C	CARD,10/20/30% MOISTURE INDICA		1	\$	9.80
AB300117	CO/HUMIDITY INDICATOR CARD		1	\$	36.00
AB300205	ASME RECEIVER		1	\$	2,200.00
AB300316	WIRE,16AWG BLACK TFFN 80C TEFL		1	\$	0.40
AB300334	WRAP,CABLE 3/4 SPIRAL OUTDOOR		1	\$	2.90
AB300366	WRAP,HOSE.91-1.45 OD BLK SPIRA		1	\$	11.90
AB300807	TAPE,1/4 HD TEFLON TAPE		1	\$	5.40
AB300901	CONNECTOR,4JIC FEM X1/4NPTM SW		1	\$	10.20
AB300903	SWIVEL,5KPSI 1/4NPT LIVE PRESS		1	\$	151.00
AB303040	ASSY,EMER STOP 1-NC 1-NO LATCH		1	\$	144.00
AB303041	ACTUATOR,EMER STOP LATCHING		1	\$	21.00
AB303042	MOUNT,EMER STOP SWITCH		1	\$	1.40
AB303043	SWITCH,NORM CLOSED CONTACT		1	\$	7.90
AB303044	SWITCH,NORM OPEN CONTACT		1	\$	7.90
AB303050	ASSY 3POS SELECT SWITCH W/CONT		1	\$	93.00
AB30378	O-RING,-25		1	\$	21.00
AB304201	TRAILER CABLE PER SAE J1067		1	\$	10.80
AB304204	PLUG,1/2NPT AL WP OUTLET BOX		1	\$	2.00
AB304251	GROMMET,ALL FIT 1.375 HOLE BLK		1	\$	0.80
AB310035	FUSE,1MDL SLOW BLOW		1	\$	6.50
AB310037	STEM,SHORT 60AL FILTER		1	\$	50.00
AB310038	STEM,MEDIUM 60AL FILTER		1	\$	66.00

AB310038A	STEM, MED 65AL		1	\$	66.00
AB310038B	TUBE,65AL COALESCER 65X10CA IN		1	\$	60.00
AB310182	COOLANT,ANTI-FREEZE		1	\$	38.00
AB310397	HOSE,1" SPIRAL RIB SMOOTH BORE		1	\$	3.64
AB310543	LIGHT,26" FLUORES 12V W/SWITCH		1	\$	184.00
AB310567	U-BOLT,7/16-14 X 1ASME RECEIVE		1	\$	7.30
AB310658	RIVET,PUSH IN		1	\$	0.40
AB310777	RECEIVER,4500PSI DOTW/VALVE&CA		1	\$	1,538.00
AB310932	PISTON SWITCH 500-6000 PSI ADJ		1	\$	242.00
AB311128	CLUTCH OIL, AIR TOOL OIL		1	\$	20.00
AB3205F	ASSY,346/347 FEM X 4JIC FEM SW		1	\$	119.00
AB3302	ASSY,MANIFOLD CONNECT W/OVALVE		1	\$	62.00
AB34606	SEAT, DELIVERY VALVE		1	\$	496.00
AB35138	PISTON, 4TH STAGE		1	\$	601.00
AB35139	4TH STAGE CYL SLEEVE		1	\$	1,189.00
AB35140	RING,4TH STAGE PISTON		1	\$	19.00
AB35333	GASKET,CYLINDER BASE-17		1	\$	11.70
AB35334	GASKET,VALVE CYLINDER-17		1	\$	9.40
AB3CAC	ELEMENT, FILTER CATALYST		1	\$	123.00
AB3CACB-5	KIT,ELEM CATALYST/CARBON 20SS		1	\$	615.00
AB3X	ELEMENT, FILTER		1	\$	124.63
AB3XB-5	ELEMENT,DESICCANT 20SS FILTER		1	\$	489.00
AB400000	OIL FILTER, LMF-V17		1	\$	35.00
AB400001	FILTER OIL LMF V16		1	\$	24.00
AB4008-3005	MANIFOLD,DUMP COLL. SKD 1		1	\$	89.00
AB4008-4003	BRACKET ASSY, PURIFIER SKD1		1	\$	375.00
AB42X5A	ELEMENT, FILTER		1	\$	84.00
AB42XCAC	ELEMENT, FILTER		1	\$	101.00
AB4457K118	FILL PIPE		1	\$	30.00
AB5007-0016	REVOLVE AIR, RESCUE AIR		1	\$	8,891.99
AB5007-1017-3	BRACKET,PANEL LIGHT RVLVR AVGR		1	\$	141.75
AB5016-2000	OPTION,2B CSCD ADD-ON CNTRL		1	\$	2,059.00
AB5016-4000	OPT,4B CSCD ADD-ON CNTRL PANEL		1	\$	2,822.00
AB5019-0101	ASSY,25FT CNTRL CABLE LE 4&5K		1	\$	299.00
AB5019-0402	MOTOR PLATE ASSEMBLY		1	\$	186.00
AB5019-0403	DUMP TEE ASSEMBLY		1	\$	180.00
AB5019-0405	HINGE PIN ASSEMBLY		1	\$	45.00
AB5019-0406	SHIPPING PIN ASSEMBLY		1	\$	26.00
AB5033-1125-41	INTERLOCK VALVE LEVER ASSY		1	\$	138.00
AB50CAC	ELEMENT, FILTER		1	\$	106.05
AB50X	ELEMENT, FILTER		1	\$	101.00
AB50X8C	ELEMENT,FILTER W/COALESCER		1	\$	135.34
AB50X9	ELEMENT,FILTER COALESCER		1	\$	122.21
AB50XAC	ELEMENT,FILTER		1	\$	101.00
AB50XCAC	ELEMENT,FILTER		1	\$	133.32
AB52X	FILT. ELEM. COLTRI UPGRADE KIT		1	\$	146.45
AB52XCAC	ELEMENT,52AL COMBO PURIFIER		1	\$	131.30
AB603AA	ELEMENT,3A SIEVE W/10% ALUMINA		1	\$	131.30
AB60CAC	ELEMENT,FILTER 60AL		1	\$	121.20
AB60X	ELEMENT,FILTER 60AL		1	\$	104.03
AB60X10C	ELEMENT,FILTER 60AL		1	\$	130.29
AB60X5A	ELEMENT,FILTER		1	\$	130.29
AB60XCAC	ELEMENT,FILTER		1	\$	137.36
AB6111-1009	VALVE,MODIFIED 3WAY TRUNNION		1	\$	866.00
AB6111-1010	COLLAR,HOKE TRUNNION VALVE SS		1	\$	35.00
AB6111-1013	ASSY,ACTUATOR ARM RVLVR INTERL		1	\$	240.00
AB6130-0111T	COVER,LIGHT/AIR MAST VINYL		1	\$	132.25
AB6130-0121-11	TANK BODY ASSEMBLY		1	\$	2,072.00
AB6130-0202	ASSY, 6FT LE CONTROLLER CABLE		1	\$	252.35
AB6130-0216	SCHEMTAIC,ELEC LIB-I 36E/D		1	\$	0.20
AB6130-0316	SCHEMATIC,PNEU LIB-I 36E/D		1	\$	0.20

AB6130-7000-1	ASSY,DUAL MAST W/OUT LIGHTS		1	\$	4,238.10
AB6130-7101	TUBE,3-1/2X3/4"INTAKE MAST BOT		1	\$	370.00
AB6130-7101C	COLLAR,INTAKE MAST LIB-I BOTTO		1	\$	125.00
AB6130-7102	TUBE,2-3/4X32" INTAKE MAST 2ND		1	\$	420.00
AB6130-7103	TUBE,2-1/2X32"INTAKE MAST 3RD		1	\$	242.00
AB6130-7103C	COLLAR,INTAKE MAST LIB-I 3RD S		1	\$	45.00
AB6130-7104	TUBE,2-1/4X30-1/2 INTAKE MAST		1	\$	137.00
AB6130-7104C	COLLAR,INTAKE MAST LIB-I 4TH S		1	\$	56.00
AB6130-7105	TUBE,2"X29-3/4 INTAKE MAST 5TH		1	\$	325.00
AB6130-7300	ASSY,2KW FLOODLIGHTS LIB-I		1	\$	1,333.50
AB6130-7301	ASSY,2KW FLOODLIGHT HEAD 120VA		1	\$	824.00
AB6130-7410	NUT,COUPLING F/LIGHT X AIR MAS		1	\$	89.00
AB6130-7411	NUT,COUPLING F/LIGHT X AIR MAS		1	\$	17.00
AB6130-7412	NUT,COUPLING F/LIGHT X AIR MAS		1	\$	17.00
AB6130-7413	NUT,COUPLING F/LIGHT X AIR MAS		1	\$	16.00
AB6130-8000	OPTION,COLD WEATHER RUN LIB-I		1	\$	2,165.00
AB6130-9101D	TRLR DOOR, SINGLE, UNPAINTED		1	\$	930.00
AB6130-9103D	TRAILER ROOF, UNPAINTED		1	\$	1,340.00
AB6130-9112	SIDE,LEFT LIB-I W/WELDED FEND		1	\$	1,532.00
AB6130-9112D	TRAILER BODY L.H.UNPAINTED		1	\$	1,470.00
AB6130-9114D	FENDER WELL COVER, UNPAINTED		1	\$	301.00
AB6130-9116	GRILL,RIGHT REAR LIB-I-36		1	\$	1,325.00
AB6130-9117	GRILL,LEFT REAR LIB-I-36		1	\$	1,325.00
AB6130-9210	SCREEN,LIB-I RIGHT SIDE COMP F		1	\$	91.00
AB6130-9220	SCREEN,LIB-I LEFT SIDE COMP FA		1	\$	84.00
AB65AL	ASSY,PURIFICATION BASE/CHAMBER		1	\$	1,475.00
AB65CAC	ELEMENT,FILTER 65AL		1	\$	118.17
AB65X	ELEMENT,FILTER 65AL		1	\$	105.04
AB65X10C	ELEMENT,FILTER 65AL		1	\$	125.24
AB65X10CA	ELEMENT,COALESCER & DRYER PURI		1	\$	140.39
AB65XCAC	ELEMENT,COMBINATION PURIFIER		1	\$	110.09
AB7206-3006	BLOCK,MANIFOLD 3X3 CAROUSEL		1	\$	55.00
AB7402	CYL(HM),20PPM CALIBRATION GAS		1	\$	79.00
AB7410	CYLINDER(HM),0PPM SPAN GAS CO		1	\$	74.00
AB8085	CAP,OIL FILLER-7-10-16-24		1	\$	36.00
ABA017615	CYL,7/16 BORE X 1 1/2 STROKE		1	\$	73.00
ABA021838	ADAPTER,M18X1.5 TO 3/8NPTF CON		1	\$	29.16
ABA022125	INTAKE HOSE ADAPTER		1	\$	57.00
ABA02350	ASSY,250/300 BAR DIN FILL ADAP		1	\$	93.00
ABA02350J	ADAPTER, 250/300 DIN X 4JIC FI		1	\$	137.00
ABA02350P	ASSY, 250/300 DIN X 1/4NPTM CH		1	\$	98.00
ABA024252	ADAPTER,52AL BASE X 42AL BOTTO		1	\$	20.00
ABA025016	ADAPTER,1/4NPT MXF 1/16 NPTF S		1	\$	28.00
ABA02614	ADAPTER,6SAE X1/4NPTF STL PIPE		1	\$	5.40
ABA02616	ADAPTER,6SAE FEM X1/4NPT MALE		1	\$	13.55
ABA043400	ANCHOR,5/8" DIA 3"LG GRDS ZINC		1	\$	16.00
ABB071306	BEARING,FLANGE 1.25 ID 1.344 O		1	\$	3.80
ABB074121	BEARING,BALL 1.3125ID 2.5625OD		1	\$	73.00
ABB083205	BELT,TIMING 390H100 39"PD 1"W		1	\$	59.00
ABB112538	BOLT,1/4-20 X3/8 GRD2 HXHD ZIN		1	\$	0.30
ABB113835	BOLT,3/8-16X3-1/4 HXHD GRD5 ZI		1	\$	0.20
ABB114214	BOLT,1/4-20 X2-1/4 SS HXHD		1	\$	1.50
ABB21001	BUSHING,MK111 SKD NYL PANEL IN		1	\$	0.90
ABB305000	ASSY,PS3 LE5000 LE4000 PWR BOA		1	\$	625.00
ABC023000	CABLE,30FT LE4K LE5K CONTROLLE		1	\$	325.00
ABC023500	CABLE,35FT LE4K LE5K CONTROLLE		1	\$	336.00
ABC100617E	END,#10 BEAD NICPLTD BRASS.193		1	\$	0.60
ABC113310	CHANNEL,STRUT 1-5/8X1-5/8 SLOT		1	\$	13.80
ABC167245	END,10-32 FEM THRD BALL JOINT		1	\$	13.80
ABC210017	COMPRESS, BARE-17 4S17 V22H-AL		1	\$	11,883.00
ABC210025	COMPRESSOR, BARE-25 4S25		1	\$	14,130.09

ABC214000	COMPRESSOR,MCH-16 3SCOLTRIBARE		1	\$	9,090.00
ABC26013	ADAPTER,1/4NPTM X 1/4NPTF SS		1	\$	26.00
ABC26145	CONNECTOR,2POLE 3WIRE 15ATL CO		1	\$	52.00
ABC26418	CONNECTOR, 60A 600V FEM CORD		1	\$	632.00
ABC42104	CORD,10/4 SO BLACK 25AMP MAX		1	\$	2.27
ABC432230	CHARGER,3AMP 230VACX12VDC AUTO		1	\$	372.00
ABC477111	CONTAINER,1000ML POLY SCREW TO		1	\$	25.00
ABE0612041	ELEMENT,AIR FILTER LDW1204 FOC		1	\$	64.00
ABE0612042	ELEMENT,OIL FILTER LDW1204FOCS		1	\$	47.00
ABE0620041	ELEMENT,INTAKE 2004 DIESEL ENG		1	\$	149.50
ABE0620042	ELEMENT,ENGINE OIL 2004 FILTER		1	\$	46.20
ABE0620043	ELEMENT,DIESEL FUEL 2004 FILTE		1	\$	75.00
ABE065387	ELEMENT,REMOTE INTAKE		1	\$	24.00
ABF04017	AIR FILTER, LMF-V17		1	\$	136.00
ABF047125	FILTER,REMOTE INTK 50CFM 1-1/4		1	\$	206.00
ABF0536T4	FAN,EXTENDED BLADE 15T4 COOLIN		1	\$	675.00
ABF13645	FUSE,FAST 5.0 AMP SUB-MINI		1	\$	2.20
ABF38100	FILTER, OIL DIESEL		1	\$	40.00
ABG020100P	GAUGE, 2-5/8" 0-100PSI PM		1	\$	99.00
ABG020400P	GAUGE, 0-400PSI PM 2-5/8 CB		1	\$	99.00
ABG020600P	GAUGE, 2-5/8" 0-600PSI PM		1	\$	99.00
ABG023000P	GAUGE, 2-5/8" 0-3000PSI PM		1	\$	152.00
ABG148000	GENERATOR,7.2KW120/240 3600RPM		1	\$	1,602.00
ABH04738	ASSY,100FT 6KPSI 4JIC SWVL HOS		1	\$	923.00
ABH070025	HOSE ASSY 40FT 3/16 ID 7K PSI		1	\$	478.00
ABH070144	ASSY,12FT HOSE 6KPSI WP 4JIC S		1	\$	235.34
ABH070329	ASSY, HOSE 24IN 7KPSI 4AN FEM		1	\$	61.00
ABH070330	ASSY, HOSE 42IN 6KPSI 4AN FEM		1	\$	107.00
ABH070336	ASSY,3FT 6KPSI 4AN FEM SWVL HO		1	\$	95.00
ABH070360	ASSY,30FT 6KPSI 4JIC FSWVL HOS		1	\$	404.00
ABH070378	ASSY,6KPSI 78"HOSE 4AN FEM SWV		1	\$	156.75
ABH070396	ASSY,8FT 6KPSI 4AN FEM SWIVELS		1	\$	158.00
ABH070700	ASSY,50FT 6KPSI 4JIC FE ENDS H		1	\$	552.00
ABH071001	ASSY,18"6KPSI 4AN FEM SWVL HOS		1	\$	82.00
ABH071120	HOSE,1-1/2 SPIRAL RIB SMOOTH B		1	\$	4.90
ABH07180	ASSY,15FT 6KPSI HOSE 4JIC FEM		1	\$	250.00
ABH072030	ASSY,30"4JIC SWIV 6KPSI HOSE		1	\$	94.00
ABH075250	ASSY, 250FT 7KPSI 4JIC FEMSWIV		1	\$	2,334.00
ABH085024	ASSY,2FT 6KPSI 4AN FEM SWVL HO		1	\$	81.00
ABH15T6-12	COMPRESSOR I/R #CCN81290850		1	\$	23,340.00
ABH15T6-230	IR 6K W/230VAC SOLENOID		1	\$	23,340.00
ABI051006	INSULATION,SOUND WHITE W/ADHES		1	\$	207.00
ABI051006-4	22X34 SOUNDFOAM WHITE/ADHES		1	\$	125.00
ABK02443	KIT,FLOW FUSE F/RVLVR REAR OUT		1	\$	254.00
ABK02853	KIT,TRAILER UNDER 80"DOT LIGHT		1	\$	100.00
ABKV1007	KIT, UNLOADER VALVE REPAIR		1	\$	387.00
ABL01002	LATCH,CAM SCREWDRIVER ACTUATED		1	\$	10.70
ABL011006	LATCH,PUSH LOCK BUTTW/OKEY LOC		1	\$	34.65
ABL011007	LATCH,RUBBER DRAW W/NYLON STRI		1	\$	21.00
ABL101010	LOCKWASHER,#10 SS SAE		1	\$	0.20
ABL101050	LOCKWASHER,#8 STL CAD PL		1	\$	0.20
ABL18016	DECAL,CONTROL PANEL TRAILER		1	\$	97.93
ABM-034020	MOISTURE SEPARATOR SIAC		1	\$	392.00
ABM097000	TAB,INTAKE TO AIR MAST MOUNTIN		1	\$	50.00
ABM6A20	CARTRIDGE MCH6 TYPE PURIFIER		1	\$	133.00
ABN020677	ASSY,CGA 677 NIPPLE & NUT		1	\$	103.00
ABN020702	ASSY,CGA 702 NIPPLE & NUT		1	\$	116.00
ABN04010	NUT,1-1/4NPT JAM NUT STEEL		1	\$	11.70
ABN041008	NUT,3/8 TWIST ON F/STRUT		1	\$	4.17
ABN041025	LOCKNUT,1/4-20 SS NYLOK		1	\$	0.40
ABN04249	NUT,1/4-20 ACORN SS		1	\$	3.10

ABN04677	CGA Nut 677		1	\$	44.60
ABN048215	JAMNUT,3/8-24 GRD2 CAD		1	\$	0.20
ABP06181	PIN,1/8 X 1-1/8 SS TENSION SPR		1	\$	0.25
ABP10422	PLUG,60A MOTOR 600V LOCKING		1	\$	720.00
ABP104220	PLUG,4AN STL END CAP		1	\$	4.20
ABP10798	INLET,2POLE 3WIRE 15A 125V FLA		1	\$	60.00
ABR11969	REGULATOR,6KPSI X 0-250 ADJ		1	\$	218.00
ABR283740	RIVET,NYLON RATCHET 9/32.346.		1	\$	0.60
ABS040726	SCREW,8-32X1/2 PHIL PNHD ZINC		1	\$	0.20
ABS041018	SCREW,4-40X3/4 SHCS SS		1	\$	0.30
ABS041019	SETSCREW,8-32 X 1/8 SS CUP POI		1	\$	2.10
ABS041160	SCREW,10-32 X 1/2 SHCS SS		1	\$	0.30
ABS051000	ASSY,1EA SEALOFF W/12"BEAD C		1	\$	41.00
ABS065000-8	SENSOR,8FT TEMP F/LE4000 LE500		1	\$	410.00
ABS10074	SHEAVE,2A 74D 7.25 OD		1	\$	177.24
ABS101002	SHEAVE, 2A49D 4.75OD PD=4.50		1	\$	129.00
ABS282380	SPRING,SS TAPER .843X1.25 OD .		1	\$	21.00
ABS40050	SWITCH,LOW OIL LEVEL-25 COMPRE		1	\$	207.00
ABS444753	SHEET,1X24X24 OPENCELL POLYU		1	\$	76.00
ABT19022	TAPE,FIBERGLASS 1"W ALUM RINFR		1	\$	2.10
ABT194524	TAPE,10MIL X3IN POLYETHYLENE G		1	\$	0.20
ABT212700	BOARD,POWER 85-264VAC 15VDC		1	\$	82.00
ABU0222	UNION,BLKHD 2MS STL		1	\$	40.00
ABUL101	KIT,REPAIR AUTO DRAIN VALVE		1	\$	190.00
ABV011000	V-BELT, B65		1	\$	29.00
ABV01B45	V-BELT,BX45 48IN OD		1	\$	31.00
ABV02004	VALVE,BLEED 1/4NPTM		1	\$	50.00
ABV021001	VALVE,DRAIN 7.5KPSI 1/4NPT STL		1	\$	12.80
ABV021006	VALVE,3/8NPTMX5/8 HOSE BRS TRU		1	\$	42.73
ABV023511	VALVE,ADJ VENT & SILENCER EXH		1	\$	98.00
ABV02796	RESTRICTOR,,047 5KPSI 1/4NPTMF		1	\$	54.00
ABV02816	VALVE,TOGGLE 6KPSI 1/4NPT ALUM		1	\$	217.00
ABV029251	VALVE,RESTRICTOR 1/8NPT ADJ		1	\$	65.50
ABV029885	RELIEF VALVE, 1ST STAGE		1	\$	67.00
ABV029895	VALVE,RELIEF 2ND STG 400PSI IR		1	\$	117.00
ABVCA955	VALVE,CHECK M-F FLOW		1	\$	84.00
ABW01065	WASHER,65AL STEM BOTTOM SEALIN		4	\$	0.30
ABW011000	WASHER,NYLON #4 .206 X .053		1	\$	0.30
ABW017145	WASHER,DELFIN 3/4 X.065 1.312		1	\$	2.30
ABW017401	FLATWASHER,5/16 NYLON .062		1	\$	0.40
ABW032000	WHEEL & TIRE,15"6BOLT X7 2540#		1	\$	690.00
ABY25309	VALVE SEAT WASHER		1	\$	14.90
CAMERAWAR61	1 YR EXT WARRANTY/EAGLE 160		1	\$	1,130.00
MS27980-9B	EYELET, BLACK, STYLE 2		1	\$	2.00
MS27983-1	BUTTON,BLACK,STYLE 4		1	\$	5.10
MS27983-2	SOCKET,BLACK,STYLE 4		1	\$	4.85
MS27983-3	STUD,BLACK,STYLE 4		1	\$	2.00





July 14, 2014

Lexington Division of Fire & Emergency Services  
Lt William Cox  
219 East 3<sup>rd</sup> Street  
Lexington, KY 40507

RE: Bluegrass Uniforms and Equipment

Lt Cox,

Please accept this letter as verification that **Bluegrass Uniforms and Equipment** is an Authorized Scott Safety Distributor, as well as an Authorized Service Center for Scott SCBA and Scott Compressor Systems.

Bluegrass Uniforms and Equipment is a "full line" Scott dealer for the state of Kentucky, and has been trained and certified by Scott Safety to test and service Scott SCBA and Scott Compressor Systems.

They currently have (4) trained service technicians on staff, and (2) mobile service units. They have store locations in Louisville, KY and Bowling Green, KY with additional sales and service capabilities if needed.

Please feel free to call with additional questions.

Thanks,

*Tim Divine*

Tim Divine  
Scott Safety  
Regional Manager KY-WV

[tdivine@tycoint.com](mailto:tdivine@tycoint.com)  
(859) 312-4588



**LIMITED WARRANTY ON AIR-PAK® 2.2/3.0/4.5 and AIR-PAK® 75™ PRODUCTS**

Scott Health & Safety (SCOTT) warrants AIR-PAK 2.2/3.0/4.5 and AIR-PAK 75 PRODUCTS (THE PRODUCTS) to be free from defects in workmanship and materials for a period of ten (10) years from the date of original manufacture by SCOTT. This warranty applies to all components of THE PRODUCTS including all accessories and optional equipment purchased and supplied at the time of original sale of THE PRODUCTS, EXCEPT pressure reducers, electrically operated devices, consumable supplies and carrying cases. SCOTT warrants all pressure reducers supplied with THE PRODUCTS to be free from defects in workmanship and materials for a period of fifteen (15) years from the date of original manufacture by SCOTT. SCOTT warrants all electrically operated devices supplied with THE PRODUCTS to be free from defects in workmanship and materials for three (3) years from the date of original manufacture by SCOTT. SCOTT further warrants all communications devices, unused consumable supplies, and carrying cases supplied with THE PRODUCTS to be free from defects in workmanship and materials for one (1) year from the date of original manufacture by SCOTT. SCOTT's obligation under this warranty is limited to replacing or repairing (at SCOTT's option) THE PRODUCTS or components shown to be defective in either workmanship or materials.

Only personnel of SCOTT or, when directed by SCOTT, authorized SCOTT agents are authorized to perform warranty obligations. This warranty does not apply to defects or damage caused by any repairs of or alterations to THE PRODUCTS made by owner or any third party unless expressly permitted by SCOTT product manuals or by written authorization from SCOTT. To obtain performance under this warranty, and as a condition precedent to any duty of SCOTT, the purchaser must return such products to SCOTT, a SCOTT authorized distributor or a SCOTT authorized service center. Any product returned to SCOTT shall be sent to "SCOTT HEALTH & SAFETY" (Attn: Warranty Claim Dept.), P.O. Box 569, Monroe, NC 28111.

This warranty does not apply to any malfunction of or damage to THE PRODUCTS resulting from accident, alteration, misuse or abuse.

THIS WARRANTY IS MADE IN LIEU OF ALL OTHER WARRANTIES, EXPRESSED OR IMPLIED INCLUDING, BUT NOT LIMITED TO, ANY IMPLIED WARRANTY OF MERCHANTABILITY OR FITNESS FOR A PARTICULAR PURPOSE. IN ADDITION, SCOTT EXPRESSLY DISCLAIMS ANY LIABILITY FOR SPECIAL, INCIDENTAL OR CONSEQUENTIAL DAMAGES IN ANY WAY CONNECTED WITH THE SALE OR USE OF SCOTT HEALTH & SAFETY PRODUCTS, AND NO OTHER FIRM OR PERSON IS AUTHORIZED TO ASSUME ANY SUCH LIABILITY.