

Lexington-Fayette Urban County Government

Lexington, Kentucky
Horse Capital of the World

Division of Central Purchasing

Date of Issue: October 16, 2017

INVITATION TO BID #143-2017 Cab & Chassis Truck with Front Loading Refuse Collection Body

Bid Opening Date: October 30, 2017

Bid Opening Time: 2:00 PM

Address: 200 East Main Street, 3rd Floor, Room 338, Lexington, Kentucky 40507

Type of Bid: Price Contract

Pre Bid Meeting: N/A

Pre Bid Time: N/A

Address: N/A

Sealed bids will be received in the office of the Division of Central Purchasing, 200 East Main Street, Lexington, Kentucky, until **2:00 PM**, prevailing local time on **10/30/2017**. Bids must be received by the above-mentioned date and time. Mailed bids should be sent to:

**Division of Central Purchasing
200 East Main Street, Room 338
Lexington, KY 40507, (859) 258-3320**

The Lexington-Fayette Urban County Government assumes no responsibility for bids that are not addressed and delivered as indicated above. **Bids that are not delivered to the Division of Central Purchasing by the stated time and date will be rejected.** All bids must be signed and have the company name and address, bid invitation number, and the name of the bid on the outside of the envelope.

Bids are to include all shipping costs to the point of delivery located at: 669 Byrd Thurman Drive, Lexington, KY

<p>Check One: <input type="checkbox"/> Bid Specifications Met <input checked="" type="checkbox"/> Exceptions to Bid Specifications. <i>Exceptions shall be itemized and attached to bid proposal submitted.</i></p>	<p>Proposed Delivery: <u>240</u> days after acceptance of bid.</p>
<p>Procurement Card Usage—The Lexington-Fayette Urban County Government may be using Procurement Cards to purchase goods and services and also to make payments. Will you accept Procurement Cards? <input type="checkbox"/> Yes <input checked="" type="checkbox"/> No</p>	

Submitted by: Lexington Truck Sales, Inc.
Firm Name

849 NANDINO BLVD.
Address

Lexington, Ky. 40511
City, State & Zip

Bid must be signed: Danny R. Lyons - General Sales Mng.
(original signature) Signature of Authorized Company Representative - Title

DANNY R. LYONS
Representative's Name (Type/ or printed)

859 231-0418 (nz) 859-231-6167
Area Code - Phone - Extension Fax #

ltssales@qx.net
E-Mail Address

13.6 Demonstrator: If specific model bid is not currently in use by the LFUCG, LFUCG reserves the right to request a demonstrator unit of the model proposed to be tested and inspected by LFUCG personnel for a minimum of five (5) business days. Demonstrator unit must be available within ten (10) business days of request.

13.7 Unit(s) shall retain all standard equipment as shown in published literature unless replaced by optional equipment specified herein. Units provided under this specification shall fully comply with any and all applicable OSHA, ANSI, and FMVSS standards as well as all applicable Federal, State, and local laws, regulations, ordinances, resolutions, and codes at time of delivery.

14.0 Addendums

14.1 **Exceptions** to any parts of these specifications shall be listed on the attached "Exception Page" with reference to the applicable paragraph number from this document.

14.2 **Warranty** page must be completed in its entirety in order to have your bid evaluated.

14.3 **Other Information** page must be completed in its entirety in order to have your bid evaluated.

15.0 Pricing

15.1 Price for 1 complete unit:

Chassis Make & Model Autocar ACX64 Packer Body Make & Model E-Z Pack Hercules
Chassis with 12 liter CNG \$ 176,297. Packer body \$ 150,713. Total \$ 327,010.⁰⁰

15.2 Price for 2 or more units:

Chassis Make & Model Autocar ACX64 Packer Body Make & Model E-Z Pack Hercules
Chassis with 12 Liter CNG \$ 176,297. Packer Body \$ 150,713. Total \$ 327,010.⁰⁰

AFFIDAVIT

Comes the Affiant, KC Schomp, and after being first duly sworn under penalty of perjury as follows:

1. His/her name is DANNY R. LYONS and he/she is the individual submitting the bid or is the authorized representative of Lexington Truck Sales, Inc., the entity submitting the bid (hereinafter referred to as "Bidder")
2. Bidder will pay all taxes and fees, which are owed to the Lexington-Fayette Urban County Government at the time the bid is submitted, prior to award of the contract and will maintain a "current" status in regard to those taxes and fees during the life of the contract.
3. Bidder will obtain a Lexington-Fayette Urban County Government business license, if applicable, prior to award of the contract.
4. Bidder has authorized the Division of Central Purchasing to verify the above-mentioned information with the Division of Revenue and to disclose to the Urban County Council that taxes and/or fees are delinquent or that a business license has not been obtained.
5. Bidder has not knowingly violated any provision of the campaign finance laws of the Commonwealth of Kentucky within the past five (5) years and the award of a contract to the Bidder will not violate any provision of the campaign finance laws of the Commonwealth.
6. Bidder has not knowingly violated any provision of Chapter 25 of the Lexington-Fayette Urban County Government Code of Ordinances, known as "Ethics Act."
7. Bidder acknowledges that "knowingly" for purposes of this Affidavit means, with respect to conduct or to circumstances described by a statute or ordinance defining an offense, that a person is aware or should have been aware that his conduct is of that nature or that the circumstance exists.

Further, Affiant sayeth naught. Ke Schomp

STATE OF Kentucky

COUNTY OF Fayette

The foregoing instrument was subscribed, sworn to and acknowledged before me by K.C. Schomp on this the 27th day of Oct, 2017

My Commission expires: 05/20/20

Justina J. Neiberk
NOTARY PUBLIC, STATE AT LARGE

Please refer to Section II. Bid Conditions, Item "U" prior to completing this form.

I. GREEN PROCUREMENT

A. ENERGY

The Lexington-Fayette Urban County Government is committed to protecting our environment and being fiscally responsible to our citizens.

The Lexington-Fayette Urban County Government mandates the use of Energy Star compliant products if they are available in the marketplace (go to www.Energystar.gov). If these products are available, but not submitted in your pricing, your bid will be rejected as non-compliant.

ENERGY STAR is a government program that offers businesses and consumers energy-efficient solutions, making it easy to save money while protecting the environment for future generations.

Key Benefits

These products use 25 to 50% less energy
Reduced energy costs without compromising quality or performance
Reduced air pollution because fewer fossil fuels are burned
Significant return on investment
Extended product life and decreased maintenance

B. GREEN SEAL CERTIFIED PRODUCTS

The Lexington-Fayette Urban County Government is also committed to using other environmentally friendly products that do not negatively impact our environment. Green Seal is a non-profit organization devoted to environmental standard setting, product certification, and public education.

Go to www.Greenseal.org to find available certified products. These products will have a reduced impact on the environment and on human health. The products to be used must be pre-approved by the LFUCG prior to commencement of any work in any LFUCG facility. If a Green Seal product is not available, the LFUCG must provide a signed waiver to use an alternate product. Please provide information on the Green Seal products being used with your bid response.

C. GREEN COMMUNITY

The Lexington-Fayette Urban County Government (LFUCG) serves as a principal, along with the University of Kentucky and Fayette County Public Schools, in the Bluegrass Partnership for a Green Community. The Purchasing Team component of the Partnership collaborates on economy of scale purchasing that promotes and enhances environmental initiatives. Specifically, when applicable, each principal is interested in obtaining best value products and/or services which promote environment initiatives via solicitations and awards from the other principals.

If your company is the successful bidder on this Invitation For Bid, do you agree to extend the same product/service pricing to the other principals of the Bluegrass Partnership for a Green Community (i.e. University of Kentucky and Fayette County Schools) if requested?

Yes No

II. Bid Conditions

- A. No bid may be withdrawn for a period of sixty (60) days after the date and time set for opening.
- B. No bid may be altered after the date and time set for opening. In the case of obvious errors, the Division of Central Purchasing may permit the withdrawal of a bid. The decision as to whether a bid may be withdrawn shall be that of the Division of Central Purchasing.
- C. Acceptance of this proposal shall be enactment of an Ordinance by the Urban County Council.
- D. The bidder agrees that the Urban County Government reserves the right to reject any and all bids for either fiscal or technical reasons, and to award each part of the bid separately or all parts to one vendor.
- E. Minor exceptions may not eliminate the bidder. The decision as to whether any exception is minor shall be entirely that of the head of the requisitioning Department or Division and the Director of the Division of Central Purchasing. The Urban County Government may waive technicalities and informalities where such waiver would best serve the interests of the Urban County Government.
- F. Manufacturer's catalogue numbers, trade names, etc., where shown herein are for descriptive purposes and are to guide the bidder in interpreting the standard of quality, design, and performance desired, and shall not be construed to exclude proposals based on furnishing other types of materials and/or services. However, any substitution or departure proposed by the bidder must be clearly noted and described; otherwise, it will be assumed that the bidder intends to supply items specifically mentioned in this Invitation for Bids.
- G. The Urban County Government may require demonstrations of the materials proposed herein prior to acceptance of this proposal.
- H. Bids must be submitted on this form and must be signed by the bidder or his authorized representative. Unsigned bids will not be considered.
- I. Bids must be submitted prior to the date and time indicated for opening. Bids submitted after this time will not be considered.
- J. All bids mailed must be marked on the face of the envelope:

"Bid on #143-2017 Cab & Chassis Truck with Front Loading Refuse Collection Body"

and addressed to: Division of Central Purchasing
 200 East Main Street, Room 338
 Lexington, Kentucky 40507

The Lexington-Fayette Urban County Government assumes no responsibility for bids that are not addressed and delivered as indicated above. Bids that are not delivered to the Division of Central Purchasing by the stated time and date will be rejected.

- K. Bidder is requested to show both unit prices and lot prices. In the event of error, the unit price shall prevail.
- L. A certified check or Bid Bond in the amount of XX percent of the bid price must be attached hereto. This check must be made payable to the Lexington-Fayette Urban County Government, and will be returned when the material and/or services specified herein have been delivered in accordance with specifications. In the event of failure to perform within the time period set forth in this bid, it is agreed the certified check may be cashed and the funds retained by the Lexington-Fayette Urban County Government as liquidated damages. Checks of unsuccessful bidders will be returned when the bid has been awarded.
- M. The delivery dates specified by bidder may be a factor in the determination of the successful bidder.
- N. Tabulations of bids received may be mailed to bidders. Bidders requesting tabulations must enclose a stamped, self-addressed envelope with the bid.
- O. The Lexington-Fayette Urban County Government is exempt from Kentucky Sales Tax and Federal Excise Tax on materials purchased from this bid invitation. Materials purchased by the bidder for construction projects are not tax exempt and are the sole responsibility of the bidder.

- P. All material furnished hereunder must be in full compliance with OSHA regulations.
- Q. If more than one bid is offered by one party, or by any person or persons representing a party, all such bids shall be rejected.
- R. Signature on the face of this bid by the Bidder or his authorized representative shall be construed as acceptance of and compliance with all terms and conditions contained herein.
- S. The Entity (regardless of whether construction contractor, non-construction contractor or supplier) agrees to provide equal opportunity in employment for all qualified persons, to prohibit discrimination in employment because of race, color, creed, national origin, sex or age, and to promote equal employment through a positive, continuing program from itself and each of its sub-contracting agents. This program of equal employment opportunity shall apply to every aspect of its employment policies and practices.
- T. The Kentucky Equal Employment Opportunity Act of 1978 (KRS 45.560-45.640) requires that any county, city, town, school district, water district, hospital district, or other political subdivision of the state shall include in directly or indirectly publicly funded contracts for supplies, materials, services, or equipment hereinafter entered into the following provisions:

During the performance of this contract, the contractor agrees as follows:

- (1) The contractor will not discriminate against any employee or applicant for employment because of race, color, religion, sex, age or national origin;*
- (2) The contractor will state in all solicitations or advertisements for employees placed by or on behalf of the contractors that all qualified applicants will receive consideration for employment without regard to race, color, religion, sex, age or national origin;*
- (3) The contractor will post notices in conspicuous places, available to employees and applicants for employment, setting forth the provisions of the non-discrimination clauses required by this section; and*
- (4) The contractor will send a notice to each labor union or representative of workers with which he has a collective bargaining agreement or other contract or understanding advising the labor union or workers' representative of the contractor's commitments under the nondiscrimination clauses.*

The Act further provides:

KRS 45.610. Hiring minorities - Information required

- (1) For the length of the contract, each contractor shall hire minorities from other sources within the drawing area, should the union with which he has collective bargaining agreements be unwilling to supply sufficient minorities to satisfy the agreed upon goals and timetable.*
- (2) Each contractor shall, for the length of the contract, furnish such information as required by KRS 45.560 to KRS 45.640 and by such rules, regulations and orders issued pursuant thereto and will permit access to all books and records pertaining to his employment practices and work sites by the contracting agency and the department for purposes of investigation to ascertain compliance with KRS 45.560 to 45.640 and such rules, regulations and orders issued pursuant thereto.*

KRS 45.620. Action against contractor - Hiring of minority contractor or subcontractor

- (1) If any contractor is found by the department to have engaged in an unlawful practice under this chapter during the course of performing under a contract or subcontract covered under KRS 45.560 to 45.640, the department shall so certify to the contracting agency and such certification shall be binding upon the contracting agency unless it is reversed in the course of judicial review.*
- (2) If the contractor is found to have committed an unlawful practice under KRS 45.560 to 45.640, the contracting agency may cancel or terminate the contract, conditioned upon a program for future compliance approved by the contracting agency and the department. The contracting agency may declare such a contractor ineligible to bid on further contracts with that agency until such time as the contractor complies in full with the requirements of KRS 45.560 to 45.640.*

- (3) *The equal employment provisions of KRS 45.560 to 45.640 may be met in part by a contractor by subcontracting to a minority contractor or subcontractor. For the provisions of KRS 45.560 to 45.640, a minority contractor or subcontractor shall mean a business that is owned and controlled by one or more persons disadvantaged by racial or ethnic circumstances.*

KRS 45.630 Termination of existing employee not required, when

Any provision of KRS 45.560 to 45.640 notwithstanding, no contractor shall be required to terminate an existing employee upon proof that that employee was employed prior to the date of the contract.

KRS 45.640 Minimum skills

Nothing in KRS 45.560 to 45.640 shall require a contractor to hire anyone who fails to demonstrate the minimum skills required to perform a particular job.

It is recommended that all of the provisions above quoted to be included as special conditions in each contract. In the case of a contract exceeding \$250,000, the contractor is required to furnish evidence that his work-force in Kentucky is representative of the available work-force in the area from which he draws employees, or to supply an Affirmative Action plan which will achieve such representation during the life of the contract.

- U. Any party, firm or individual submitting a proposal pursuant to this invitation must be in compliance with the requirements of the Lexington-Fayette Urban County Government regarding taxes and fees before they can be considered for award of this invitation and must maintain a "current" status with regard to those taxes and fees throughout the term of the contract. The contractor must be in compliance with Chapter 13 from the Code of Ordinances of the Lexington-Fayette Urban County Government. The contractor must be in compliance with Ordinance 35-2000 pursuant to contractor registration with the Division of Building Inspection. If applicable, said business must have a Fayette County business license.

Pursuant to KRS 45A.343 and KRS 45A.345, the contractor shall

- (1) *Reveal any final determination of a violation by the contractor within the previous five year period pursuant to KRS Chapters 136 (corporation and utility taxes), 139 (sales and use taxes), 141 (income taxes), 337 (wages and hours), 338 (occupational safety and health of employees), 341 (unemployment and compensation) and 342 (labor and human rights) that apply to the contractor; and*
- (2) *Be in continuous compliance with the above-mentioned KRS provisions that apply to the contractor for the duration of the contract.*

A contractor's failure to reveal the above or to comply with such provisions for the duration of the contract shall be grounds for cancellation of the contract and disqualification of the contractor from eligibility for future contracts for a period of two (2) years.

- V. Vendors who respond to this invitation have the right to file a notice of contention associated with the bid process or to file a notice of appeal of the recommendation made by the Director of Central Purchasing resulting from this invitation.

Notice of contention with the bid process must be filed within 3 business days of the bid/proposal opening by (1) sending a written notice, including sufficient documentation to support contention, to the Director of the Division of Central Purchasing or (2) submitting a written request for a meeting with the Director of Central Purchasing to explain his/her contention with the bid process. After consulting with the Commissioner of Finance the Chief Administrative Officer and reviewing the documentation and/or hearing the vendor, the Director of Central Purchasing shall promptly respond in writing findings as to the compliance with bid processes. If, based on this review, a bid process irregularity is deemed to have occurred the Director of Central Purchasing will consult with the Commissioner of Finance, the Chief Administrative Officer and the Department of Law as to the appropriate remedy.

Notice of appeal of a bid recommendation must be filed within 3 business days of the bid recommendation by (1) sending a written notice, including sufficient documentation to support appeal, to the Director, Division of Central Purchasing or (2) submitting a written request for a meeting with the Director of Central Purchasing to explain his appeal. After reviewing the documentation and/or hearing the vendor and consulting with the Commissioner of Finance and the Chief Administrative Officer, the Director of Central Purchasing shall in writing, affirm or withdraw the recommendation.

III. Procurement Contract Bid Conditions

- A. The terms of this agreement shall be for 1 year(s) from the date of acceptance of this contract by the Lexington-Fayette Urban County Government. This agreement may be automatically extended for an additional 1 year(s) renewal. This contract may be canceled by either party thirty (30) days after delivery by canceling party of written notice of intent to cancel to the other contracting party.
- B. Price Changes **(Space Checked Applies)**
 - (X) 1. Prices quoted in response to the Invitation shall be firm prices for the first 90 days of the Procurement Contract. After 90 days, prices may be subject to revision and such changes shall be based on general industry changes. Revision may be either increases or decreases and may be requested by either party. There will be no more than one (1) price adjustment per quarter. Requests for price changes shall be received in writing at least twenty (20) days prior to the effective date and are subject to written acceptance before becoming effective. Proof of the validity of a request for revision shall be responsibility of the requesting party. The Lexington-Fayette Urban County Government shall receive the benefit of any decline that the seller shall offer his other accounts.
 - () 2. No provision for price change is made herein. Prices are to be firm for the term of this contract.
 - () 3. Procurement Level Contract
- C. If any contract item is not available from the vendor, the Lexington-Fayette Urban County Government, at its option, may permit the item to be back-ordered or may procure the item on the open market.
- D. All invoices must bear reference to the Lexington-Fayette Urban County Government Purchasing document numbers which are being billed.
- E. This contract may be canceled by the Lexington-Fayette Urban County Government if it is determined that the Bidder has failed to perform under the terms of this agreement, such cancellation to be effective upon receipt of written notice of cancellation by the Bidder.
- F. No substitutions for articles specified herein may be made without prior approval of the Division of Central Purchasing.

EQUAL OPPORTUNITY AGREEMENT

The Law

- Title VII of the Civil Rights Act of 1964 (amended 1972) states that it is unlawful for an employer to discriminate in employment because of race, color, religion, sex, age (40-70 years) or national origin.
- Executive Order No. 11246 on Nondiscrimination under Federal contract prohibits employment discrimination by contractor and sub-contractor doing business with the Federal Government or recipients of Federal funds. This order was later amended by Executive Order No. 11375 to prohibit discrimination on the basis of sex.
- Section 503 of the Rehabilitation Act of 1973 states:

The Contractor will not discriminate against any employee or applicant for employment because of physical or mental disability.

- Section 2012 of the Vietnam Era Veterans Readjustment Act of 1973 requires Affirmative Action on behalf of disabled veterans and veterans of the Vietnam Era by contractors having Federal contracts.
- Section 206(A) of Executive Order 12086, Consolidation of Contract Compliance Functions for Equal Employment Opportunity, states:

The Secretary of Labor may investigate the employment practices of any Government contractor or sub-contractor to determine whether or not the contractual provisions specified in Section 202 of this order have been violated.

The Lexington-Fayette Urban County Government practices Equal Opportunity in recruiting, hiring and promoting. It is the Government's intent to affirmatively provide employment opportunities for those individuals who have previously not been allowed to enter into the mainstream of society. Because of its importance to the local Government, this policy carries the full endorsement of the Mayor, Commissioners, Directors and all supervisory personnel. In following this commitment to Equal Employment Opportunity and because the Government is the benefactor of the Federal funds, it is both against the Urban County Government policy and illegal for the Government to let contracts to companies which knowingly or unknowingly practice discrimination in their employment practices. Violation of the above mentioned ordinances may cause a contract to be canceled and the contractors may be declared ineligible for future consideration.

Please sign this statement in the appropriate space acknowledging that you have read and understand the provisions contained herein. Return this document as part of your application packet.

Bidders

I/We agree to comply with the Civil Rights Laws listed above that govern employment rights of minorities, women, veteran status, disability and age.

Signature



Name of Business

GENERAL PROVISIONS OF BID CONTRACT

By signing the below, bidder acknowledges that it understands and agrees with the following provisions related to its bid response and the provision of any goods or services to LFUCG upon selection by LFUCG pursuant to the bid request:

1. Bidder shall comply with all Federal, State & Local regulations concerning this type of service or good. All applicable state laws, ordinances and resolutions (including but not limited to Section 2-33 (Discrimination due to sexual orientation or gender identity) and Chapter 13 (Licenses and Regulations) of the Lexington-Fayette Urban County Government Code of Ordinances, and Resolution No. 484-17 (Minority, Women, and Veteran-Owned Businesses)) and the regulations of all authorities having jurisdiction over the project shall apply to the contract, and shall be deemed to be incorporated herein by reference.
2. Failure to submit ALL forms and information required by LFUCG may be grounds for disqualification.
3. Addenda: All addenda and IonWave Q&A, if any, must be considered by the bidder in making its response, and such addenda shall be made a part of the requirements of the bid contract. Before submitting a bid response, it is incumbent upon bidder to be informed as to whether any addenda have been issued, and the failure of the bidder to cover any such addenda may result in disqualification of that response.
4. Bid Reservations: LFUCG reserves the right to reject any or all bid responses, to award in whole or part, and to waive minor immaterial defects in proposals. LFUCG may consider any alternative proposal that meets its basic needs.
5. Liability: LFUCG is not responsible for any cost incurred by bidder in the preparation of its response.
6. Changes/Alterations: Bidder may change or withdraw a proposal at any time prior to the opening; however, no oral modifications will be allowed. Only letters, or other formal written requests for modifications or corrections of a previously submitted proposal which is addressed in the same manner as the bid response, and received by LFUCG prior to the scheduled closing time for receipt of bids, will be accepted. The bid response when opened, will then be corrected in accordance with such written request(s), provided that the written request is contained in a sealed envelope which is plainly marked "modifications of bid response".
7. Clarification of Submittal: LFUCG reserves the right to obtain clarification of any point in a bid or to obtain additional information from any bidder.
8. Bribery Clause: By his/her signature on its response, bidder certifies that no employee of his/hers, any affiliate or subcontractor, has bribed or attempted to bribe an officer or employee of the LFUCG.
9. Additional Information: While not necessary, the bidder may include any product brochures, software documentation, sample reports, or other documentation that may assist LFUCG in better understanding and evaluating the bid response. Additional documentation shall not serve as a substitute for other documentation which is required by the LFUCG to be submitted with the bid response.
10. Ambiguity, Conflict or other Errors: If a bidder discovers any ambiguity, conflict, discrepancy, omission or other error in the bid request of LFUCG, it shall immediately notify LFUCG of such error in writing and request modification or clarification of the document if allowable by the LFUCG.
11. Agreement to Bid Terms: In submitting its bid response, the bidder agrees that it has carefully examined the specifications and all provisions relating to LFUCG's bid request, including but not limited to the bid contract. By submission of its bid response, bidder states that it understands the meaning, intent and requirements of LFUCG's bid request and agrees to the same. The successful bidder shall warrant that it is familiar with and understands all provisions herein and shall warrant that it can comply with them. No additional compensation to bidder shall be authorized for services, expenses, or goods reasonably covered under these provisions that the bidder omits from its bid response.

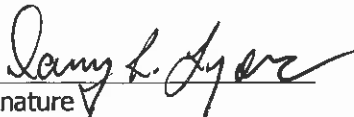
12. Cancellation: LFUCG may unilaterally terminate the bid contract with the selected bidder(s) at any time, with or without cause, by providing at least thirty (30) days advance written notice unless a different advance written notice period is negotiated prior to contract approval. Payment for services or goods received prior to termination shall be made by the LFUCG provided these goods or services were provided in a manner acceptable to the LFUCG. Payment for those goods and services shall not be unreasonably withheld.
13. Assignment of Contract: The selected bidder(s) shall not assign or subcontract any portion of the bid contract with LFUCG without the express written consent of LFUCG. Any purported assignment or subcontract in violation hereof shall be void. It is expressly acknowledged that LFUCG shall never be required or obligated to consent to any request for assignment or subcontract; and further that such refusal to consent can be for any or no reason, fully within the sole discretion of LFUCG.
14. No Waiver: No failure or delay by LFUCG in exercising any right, remedy, power or privilege hereunder, nor any single or partial exercise thereof, nor the exercise of any other right, remedy, power or privilege shall operate as a waiver hereof or thereof. No failure or delay by LFUCG in exercising any right, remedy, power or privilege under or in respect of this bid proposal or bid contract shall affect the rights, remedies, powers or privileges of LFUCG hereunder or shall operate as a waiver thereof.
15. Authority to do Business: Each bidder must be authorized to do business under the laws of the Commonwealth of Kentucky and must be in good standing and have full legal capacity to provide the goods or services specified in the bid proposal. Each bidder must have all necessary right and lawful authority to submit the bid response and enter into the bid contract for the full term hereof including any necessary corporate or other action authorizing the bidder to submit the bid response and enter into this bid contract. If requested, the bidder will provide LFUCG with a copy of a corporate resolution authorizing this action and/or a letter from an attorney confirming that the proposer is authorized to do business in the Commonwealth of Kentucky. All bid responses must be signed by a duly authorized officer, agent or employee of the bidder.
16. Governing Law: This bid request and bid contract shall be governed by and construed in accordance with the laws of the Commonwealth of Kentucky. In the event of any proceedings regarding this matter, the bidder agrees that the venue shall be the Fayette County Circuit Court or the U.S. District Court for the Eastern District of Kentucky, Lexington Division and that the bidder expressly consents to personal jurisdiction and venue in such Court for the limited and sole purpose of proceedings relating to these matters or any rights or obligations arising thereunder.
17. Ability to Meet Obligations: Bidder affirmatively states that there are no actions, suits or proceedings of any kind pending against bidder or, to the knowledge of the bidder, threatened against the bidder before or by any court, governmental body or agency or other tribunal or authority which would, if adversely determined, have a materially adverse effect on the authority or ability of bidder to perform its obligations under this bid response or bid contract, or which question the legality, validity or enforceability hereof or thereof.
18. Price Discrepancy: In case of price discrepancy, unit bid price written in words will prevail followed by unit price written in numbers then total amount bid per line item.
19. Bidder understands and agrees that its employees, agents, or subcontractors are not employees of LFUCG for any purpose whatsoever. Bidder is an independent contractor at all times related to the bid response or bid contract.
20. If any term or provision of this bid contract shall be found to be illegal or unenforceable, the remainder of the contract shall remain in full force and such term or provision shall be deemed stricken.

Signature

10/25/17
Date

WORKFORCE ANALYSIS FORM

Name of Organization: Lexington Truck Sales, Inc.

Categories	Total	White (Not Hispanic or Latino)		Hispanic or Latino		Black or African-American (Not Hispanic or Latino)		Native Hawaiian and Other Pacific Islander (Not Hispanic or Latino)		Asian (Not Hispanic or Latino)		American Indian or Alaskan Native (not Hispanic or Latino)		Two or more races (Not Hispanic or Latino)		Total	
		M	F	M	F	M	F	M	F	M	F	M	F	M	F	M	F
Administrators		1														1	
Professionals		15											1			16	
Superintendents			1														1
Supervisors		5														5	
Foremen																	
Technicians		11		2		1										14	
Protective Service																	
Para-Professionals																	
Office/Clerical			3														3
Skilled Craft																	
Service/Maintenance		1														1	
Total:		33	4	2		1								1		37	4

Prepared by: DANNY R. LYONS General Sales Mgr. Date: 10/25/17
 (Name and Title)

Revised 2015-Dec-15

**DIRECTOR, DIVISION OF CENTRAL PURCHASING
LEXINGTON-FAYETTE URBAN COUNTY GOVERNMENT
200 EAST MAIN STREET
LEXINGTON, KENTUCKY 40507**

**NOTICE OF REQUIREMENT FOR AFFIRMATIVE ACTION TO ENSURE
EQUAL EMPLOYMENT OPPORTUNITIES AND DBE CONTRACT PARTICIPATION**

The Lexington-Fayette Urban County Government has set a goal that not less than ten percent (10%) of the total value of this contract be subcontracted to MBE/WBE's. The goal for the utilization of certified MBE/WBE's as subcontractors are recommended goals. Contractors who fail to meet such goals will be expected to provide written explanations to the Director of the Division of Central Purchasing of efforts they have made to accomplish the recommended goals and the extent to which they are successful in accomplishing the recommended goals will be a consideration in the procurement process.

For assistance in locating MBE/WBE Subcontractors contact Sherita Miller at 859/258-3320 or by writing the address listed below:

Sherita Miller, Division of Central Purchasing
Lexington-Fayette Urban County Government
200 East Main Street – Room 338
Lexington, Kentucky 40507
smiller@lexingtonky.gov

Lexington-Fayette Urban County Government
MWDBE PARTICIPATION GOALS

A. GENERAL

- 1) The LFUCG request all potential contractors to make a concerted effort to include Minority-Owned (MBE), Woman-Owned (WBE) and Disadvantaged (DBE) Business Enterprises and Veteran-Owned Small Businesses (VOSB) as subcontractors or suppliers in their bids.
- 2) Toward that end, the LFUCG has established 10% of total procurement costs as a Goal for participation of Minority-Owned, Woman-Owned and Disadvantaged Businesses on this contract.
- 3) **It is therefore a request of each Bidder to include in its bid, the same goal (10%) for MWDBE participation and other requirements as outlined in this section.**
- 4) The LFUCG has also established a 3% of total procurement costs as a Goal for participation for of Veteran-Owned Businesses.
- 5) **It is therefore a request of each Bidder to include in its bid, the same goal (3%) for Veteran-Owned participation and other requirements as outlined in this section.**

B. PROCEDURES

- 1) The successful bidder will be required to report to the LFUCG, the dollar amounts of all payments submitted to Minority-Owned or Woman-Owned subcontractors and suppliers for work done or materials purchased for this contract. (See Subcontractor Monthly Payment Report)
- 2) Replacement of a Minority-Owned, Woman-Owned or Veteran-Owned subcontractor or supplier listed in the original submittal must be requested in writing and must be accompanied by documentation of Good Faith Efforts to replace the subcontractor / supplier with another MWDBE Firm; this is subject to approval by the LFUCG. (See LFUCG MWDBE Substitution Form)
- 3) For assistance in identifying qualified, certified businesses to solicit for potential contracting opportunities, bidders may contact:
 - a) The Lexington-Fayette Urban County Government, Division of Central Purchasing (859-258-3320)
- 4) The LFUCG will make every effort to notify interested MWDBE and Veteran-Owned subcontractors and suppliers of each Bid Package, including information on the scope of work, the pre-bid meeting time and location, the bid date, and all other pertinent information regarding the project.

C. DEFINITIONS

- 1) A Minority-Owned Business Enterprise (MBE) is defined as a business which is certified as being at least 51% owned and operated by persons of African American, Hispanic, Asian, Pacific Islander, American Indian or Alaskan Native Heritage.
- 2) A Woman-Owned Business Enterprise (WBE) is defined as a business which is certified as being at least 51% owned and operated by one or more Non-Minority Females.
- 3) A Disadvantaged Business (DBE) is defined as a business which is certified as being at least 51% owned and operated by a person(s) that are economically and socially disadvantaged.

- 4) A Veteran-Owned Small Business (VOSB) is defined as a business which is certified as being at least 51% owned and operated by a veteran and/or a service disabled veteran.
- 5) Good Faith Efforts are efforts that, given all relevant circumstances, a bidder or proposer actively and aggressively seeking to meet the goals, can reasonably be expected to make. In evaluating good faith efforts made toward achieving the goals, whether the bidder or proposer has performed the efforts outlined in the Obligations of Bidder for Good Faith Efforts outlined in this document will be considered, along with any other relevant factors.

D. OBLIGATION OF BIDDER FOR GOOD FAITH EFFORTS

- 1) **The bidder shall make a Good Faith Effort to achieve the Participation Goal for MWDBE subcontractors/suppliers. The failure to meet the goal shall not necessarily be cause for disqualification of the bidder; however, bidders not meeting the goal are required to furnish with their bids written documentation of their Good Faith Efforts to do so.**
- 2) Award of Contract shall be conditioned upon satisfaction of the requirements set forth herein.
- 3) The Form of Proposal includes a section entitled "MWDBE Participation Form". The applicable information must be completed and submitted as outlined below.
- 4) **Failure to submit this information as requested may be cause for rejection of bid or delay in contract award.**

E. DOCUMENTATION REQUIRED FOR GOOD FAITH EFFORTS

- 1) Bidders reaching the Goal are required to submit only the MWDBE Participation Form." The form must be fully completed including names and telephone number of participating MWDBE firm(s); type of work to be performed; estimated value of the contract and value expressed as a percentage of the total Lump Sum Bid Price. The form must be signed and dated, and is to be submitted with the bid.
- 2) Bidders not reaching the Goal must submit the "MWDBE Participation Form", the "Quote Summary Form" and a written statement documenting their Good Faith Effort to do so. If bid includes no MWDBE and/or Veteran participation, bidder shall enter "None" on the subcontractor / supplier form). In addition, the bidder must submit written proof of their Good Faith Efforts to meet the Participation Goal:
 - a. Advertised opportunities to participate in the contract in at least two (2) publications of general circulation media; trade and professional association publications; small and minority business or trade publications; and publications or trades targeting minority, women and disadvantaged businesses not less than fifteen (15) days prior to the deadline for submission of bids to allow MWDBE firms and Veteran-Owned businesses to participate.
 - b. Included documentation of advertising in the above publications with the bidders good faith efforts package
 - c. Attended LFUCG Central Purchasing Economic Inclusion Outreach event
 - d. Attended pre-bid meetings that were scheduled by LFUCG to inform MWDBEs and/or

Veteran-Owned businesses of subcontracting opportunities

- e. Sponsored Economic Inclusion event to provide networking opportunities for prime contractors and MWDBE firms and Veteran-Owned businesses
- f. Requested a list of MWDBE and/or Veteran subcontractors or suppliers from LFUCG and showed evidence of contacting the companies on the list(s).
- g. Contacted organizations that work with MWDBE companies for assistance in finding certified MWDBE firms and Veteran-Owned businesses to work on this project. Those contacted and their responses should be a part of the bidder's good faith efforts documentation.
- h. Sent written notices, by certified mail, email or facsimile, to qualified, certified MWDBEs soliciting their participation in the contract not less than seven (7) days prior to the deadline for submission of bids to allow them to participate effectively.
- i. Followed up initial solicitations by contacting MWDBEs and Veteran-Owned businesses to determine their level of interest.
- j. Provided the interested MWDBE firm and/or Veteran-Owned business with adequate and timely information about the plans, specifications, and requirements of the contract.
- k. Selected portions of the work to be performed by MWDBE firms and/or Veteran-Owned businesses in order to increase the likelihood of meeting the contract goals. This includes, where appropriate, breaking out contract work items into economically feasible units to facilitate MWDBE and Veteran participation, even when the prime contractor may otherwise perform these work items with its own workforce.
- l. Negotiated in good faith with interested MWDBE firms and Veteran-Owned businesses not rejecting them as unqualified without sound reasons based on a thorough investigation of their capabilities. Any rejection should be so noted in writing with a description as to why an agreement could not be reached.
- m. Included documentation of quotations received from interested MWDBE firms and Veteran-Owned businesses which were not used due to uncompetitive pricing or were rejected as unacceptable and/or copies of responses from firms indicating that they would not be submitting a bid.
- n. Bidder has to submit sound reasons why the quotations were considered unacceptable. The fact that the bidder has the ability and/or desire to perform the contract work with its own forces will not be considered a sound reason for rejecting a MWDBE and/or Veteran-Owned business's quote. Nothing in this provision shall be construed to require the bidder to accept unreasonable quotes in order to satisfy MWDBE and Veteran goals.
- o. Made an effort to offer assistance to or refer interested MWDBE firms and Veteran-Owned businesses to obtain the necessary equipment, supplies, materials, insurance and/or

bonding to satisfy the work requirements of the bid proposal.

- p. Made efforts to expand the search for MWBE firms and Veteran-Owned businesses beyond the usual geographic boundaries.
- q. Other--any other evidence that the bidder submits which may show that the bidder has made reasonable good faith efforts to include MWDBE and Veteran participation.

Note: Failure to submit any of the documentation requested in this section may be cause for rejection of bid. Bidders may include any other documentation deemed relevant to this requirement which is subject to review by the MBE Liaison. Documentation of Good Faith Efforts must be submitted with the Bid, if the participation Goal is not met.



LEXINGTON

MINORITY BUSINESS ENTERPRISE PROGRAM

Sherita Miller, MPA
Minority Business Enterprise Liaison
Division of Central Purchasing
Lexington-Fayette Urban County Government
200 East Main Street
Lexington, KY 40507
smiller@lexingtonky.gov
859-258-3323

OUR MISSION: The mission of the Minority Business Enterprise Program is to facilitate the full participation of minority and women owned businesses in the procurement process and to promote economic inclusion as a business imperative essential to the long term economic viability of Lexington-Fayette Urban County Government.

To that end the city council adopted and implemented resolution 167-91—Disadvantaged Business Enterprise (DBE) 10% Goal Plan in July of 1991. The resolution states in part (a full copy is available in Central Purchasing):

“A Resolution supporting adoption of the administrative plan for a ten percent (10%) Minimum goal for disadvantaged business enterprise participation in Lexington-Fayette Urban County Government construction and professional services contracts; Providing that as part of their bids on LFUCG construction contracts, general Contractors shall make a good faith effort to award at least ten percent (10%) of All subcontracts to disadvantaged business enterprises; providing that divisions of LFUCG shall make a good faith effort to award at least ten percent of their Professional services and other contracts to disadvantaged business enterprises...”

A Disadvantaged Business Enterprise is defined as a business that has been certified as being at least 51% owned, operated and managed by a U.S. Citizen of the following groups:

- African-American
- Hispanic-American
- Asian/Pacific Islander
- Native American/Native Alaskan
- Non-Minority Female
- Economically and Socially Disadvantaged

In addition, to that end the city council also adopted and implemented resolution 167-91—Veteran-owned Businesses, 3% Goal Plan in July of 2015. The resolution states in part (a full copy is available in Central Purchasing):

“A resolution adopting a three percent (3%) minimum goal for certified veteran-owned small businesses and service disabled veteran-owned businesses for certain of those Lexington-Fayette Urban County contracts related to construction for professional services, and authorizing the Division of Purchasing to adopt and implement guidelines and/or policies consistent with the provisions and intent of this resolution by no later than July 1, 2015.”

We have compiled the list below to help you locate certified MBE, WBE and DBE certified businesses. Below is a

listing of contacts for LFUCG Certified MWDBEs and Veteran-Owned Small Businesses in
<https://lexingtonky.ionwave.net>

Business	Contact	Email Address	Phone
LFUCG	Sherita Miller	smiller@lexingtonky.gov	859-258-3323
Commerce Lexington – Minority Business Development	Tyrone Tyra	tyra@commercelexington.com	859-226-1625
Tri-State Minority Supplier Diversity Council	Susan Marston	smarston@tsmsdc.com	502-365-9762
Small Business Development Council	Shirie Hawkins UK SBDC	smack@uky.edu	859-257-7666
Community Ventures Corporation	Phyllis Alcorn	palcorn@cvky.org	859-231-0054
KY Transportation Cabinet (KYTC)	Melvin Bynes	Melvin.bynes2@ky.gov	502-564-3601
KYTC Pre-Qualification	Shella Eagle	Shella.Eagle@ky.gov	502-782-4815
Ohio River Valley Women’s Business Council (WBENC)	Sheila Mixon	smixon@orvwbc.org	513-487-6537
Kentucky MWBE Certification Program	Yvette Smith, Kentucky Finance Cabinet	Yvette.Smith@ky.gov	502-564-8099
National Women Business Owner’s Council (NWBOC)	Janet Harris-Lange	janet@nwbo.org	800-675-5066
Small Business Administration	Robert Coffey	robertcoffey@sba.gov	502-582-5971
LaVoz de Kentucky	Andres Cruz	lavozy@yaho.com	859-621-2106
The Key News Journal	Patrice Muhammad	paatricem@keynewsjournal.com	859-373-9428



LEXINGTON

LFUCG MWDBE PARTICIPATION FORM

Bid/RFP/Quote Reference # 143-2017

The MWDBE and/or veteran subcontractors listed have agreed to participate on this Bid/RFP/Quote. If any substitution is made or the total value of the work is changed prior to or after the job is in progress, it is understood that those substitutions must be submitted to Central Purchasing for approval immediately. **Failure to submit a completed form may cause rejection of the bid.**

MWDBE Company, Name, Address, Phone, Email	MBE WBE or DBE	Work to be Performed	Total Dollar Value of the Work	% Value of Total Contract
1. J. Edinger & Son 1010 Story Ave. Louisville, Ky. 40206		E-Z Pack	150,713.	48%
2.				
3.				
4.				

The undersigned company representative submits the above list of MWDBE firms to be used in accomplishing the work contained in this Bid/RFP/Quote. Any misrepresentation may result in the termination of the contract and/or be subject to applicable Federal and State laws concerning false statements and false claims.

Lexington Truck Sales
Company

Danny L. Lyons
Company Representative

10/25/17
Date

General Sales Manager
Title



LEXINGTON

LFUCG MWDBE SUBSTITUTION FORM

Bid/RFP/Quote Reference # 143-2017

The substituted MWDBE and/or veteran subcontractors listed below have agreed to participate on this Bid/RFP/Quote. These substitutions were made prior to or after the job was in progress. These substitutions were made for reasons stated below and are now being submitted to Central Purchasing for approval. By the authorized signature of a representative of our company, we understand that this information will be entered into our file for this project. **Failure to submit this form may cause rejection of the bid.**

SUBSTITUTED MWDBE Company Name, Address, Phone, Email	MWDBE Formally Contracted/ Name, Address, Phone, Email	Work to Be Performed	Reason for the Substitution	Total Dollar Value of the Work	% Value of Total Contract
1. N/A					
2.					
3.					
4.					

The undersigned acknowledges that any misrepresentation may result in termination of the contract and/or be subject to applicable Federal and State laws concerning false statements and false claims.

Lexington Truck Sales
Company

10/25/17
Date

Danny R. Lyons
Company Representative

General Sales Mng.
Title



LEXINGTON

MWDBE QUOTE SUMMARY FORM

Bid/RFP/Quote Reference # 143-2017

The undersigned acknowledges that the minority and/or veteran subcontractors listed on this form did submit a quote to participate on this project. Failure to submit this form may cause rejection of the bid.

Company Name <i>Lexington Truck Sales</i>	Contact Person <i>DANNY E. LYONS</i>
Address/Phone/Email <i>849 NANDINO Blvd. Lexington, Ky. 859-231-0418 ltsales@rx.net</i>	Bid Package / Bid Date <i>10/30/17</i>

MWDBE Company Address	Contact Person	Contact Information (work phone, Email, cell)	Date Contacted	Services to be performed	Method of Communication (email, phone meeting, ad, event etc)	Total dollars \$\$ Do Not Leave Blank (Attach Documentation)	MBE * AA HA AS NA Female	Veteran

(MBE designation / AA=African American / HA= Hispanic American/AS = Asian American/Pacific Islander/ NA= Native American)

The undersigned acknowledges that all information is accurate. Any misrepresentation may result in termination of the contract and/or be subject to applicable Federal and State laws concerning false statements and claims.

Lexington Truck Sales
Company

DANNY E. LYONS
Company Representative

10/25/17
Date

General Sales Mng.
Title



LEXINGTON

LFUCG SUBCONTRACTOR MONTHLY PAYMENT REPORT

The LFUCG has a 10% goal plan adopted by city council to increase the participation of minority and women owned businesses in the procurement process. The LFUCG also has a 3% goal plan adopted by cited council to increase the participation of veteran owned businesses in the procurement process. In order to measure that goal LFUCG will track spending with MWDBE and Veteran contractors on a monthly basis. By the signature below of an authorized company representative, you certify that the information is correct, and that each of the representations set forth below is true. Any misrepresentation may result in termination of the contract and/or prosecution under applicable Federal and State laws concerning false statements and false claims. Please submit this form monthly to the Division of Central Purchasing/ 200 East Main Street / Room 338 / Lexington, KY 40507.

Bid/RFP/Quote # 143-2017
 Total Contract Amount Awarded to Prime Contractor for this Project _____

Project Name/ Contract # <i>Front Loading Refuse Truck</i>	Work Period/ From: _____ To: _____
Company Name: <i>Lexington Truck Sales, Inc.</i>	Address: <i>849 Nandino Blvd. Lexington, Ky.</i>
Federal Tax ID: <i>61-1245687</i>	Contact Person: <i>DANNY R LYONS</i>

Subcontractor Vendor ID (name, address, phone, email)	Description of Work	Total Subcontract Amount	% of Total Contract Awarded to Prime for this Project	Total Amount Paid for this Period	Purchase Order number for subcontractor work (please attach PO)	Scheduled Project Start Date	Scheduled Project End Date
<i>N/A</i>							

By the signature below of an authorized company representative, you certify that the information is correct, and that each of the representations set forth below is true. Any misrepresentations may result in the termination of the contract and/or prosecution under applicable Federal and State laws concerning false statements and false claims.

Lexington Truck Sales Company
DANNY R. LYONS Company Representative
10/25/17 Date
General Sales Mng. Title

LFUCG STATEMENT OF GOOD FAITH EFFORTS

Bid/RFP/Quote # 143-2017

By the signature below of an authorized company representative, we certify that we have utilized the following Good Faith Efforts to obtain the maximum participation by MWDBE and Veteran-Owned business enterprises on the project and can supply the appropriate documentation.

_____ Advertised opportunities to participate in the contract in at least two (2) publications of general circulation media; trade and professional association publications; small and minority business or trade publications; and publications or trades targeting minority, women and disadvantaged businesses not less than fifteen (15) days prior to the deadline for submission of bids to allow MWDBE firms and Veteran-Owned businesses firms to participate.

_____ Included documentation of advertising in the above publications with the bidders good faith efforts package

_____ Attended LFUCG Central Purchasing Economic Inclusion Outreach event

_____ Attended pre-bid meetings that were scheduled by LFUCG to inform MWDBEs and/or Veteran-Owned Businesses of subcontracting opportunities

_____ Sponsored Economic Inclusion event to provide networking opportunities for prime contractors and MWDBE firms and Veteran-Owned businesses

_____ requested a list of MWDBE and/or Veteran subcontractors or suppliers from LFUCG and showed evidence of contacting the companies on the list(s).

_____ Contacted organizations that work with MWDBE companies for assistance in finding certified MWBDE firms and Veteran-Owned businesses to work on this project. Those contacted and their responses should be a part of the bidder's good faith efforts documentation.

_____ Sent written notices, by certified mail, email or facsimile, to qualified, certified MWDBEs soliciting their participation in the contract not less than seven (7) days prior to the deadline for submission of bids to allow them to participate effectively.

_____ Followed up initial solicitations by contacting MWDBEs and Veteran-Owned businesses to determine their level of interest.

_____ Provided the interested MWBDE firm and/or Veteran-Owned business with adequate and timely information about the plans, specifications, and requirements of the contract.

_____ Selected portions of the work to be performed by MWDBE firms and/or Veteran-Owned businesses in order to increase the likelihood of meeting the contract goals. This includes, where appropriate, breaking out contract work items into economically feasible units to facilitate MWDBE and Veteran participation, even when the prime contractor may otherwise perform these work items with its own workforce

_____ Negotiated in good faith with interested MWDBE firms and Veteran-Owned businesses not rejecting them as unqualified without sound reasons based on a thorough investigation of their capabilities. Any rejection should be so noted in writing with a description as to why an

agreement could not be reached.

_____ Included documentation of quotations received from interested MWDBE firms and Veteran-Owned businesses which were not used due to uncompetitive pricing or were rejected as unacceptable and/or copies of responses from firms indicating that they would not be submitting a bid.

_____ Bidder has to submit sound reasons why the quotations were considered unacceptable. The fact that the bidder has the ability and/or desire to perform the contract work with its own forces will not be considered a sound reason for rejecting a MWDBE and/or Veteran-Owned business's quote. Nothing in this provision shall be construed to require the bidder to accept unreasonable quotes in order to satisfy MWDBE and Veteran goals.

_____ Made an effort to offer assistance to or refer interested MWDBE firms and Veteran-Owned businesses to obtain the necessary equipment, supplies, materials, insurance and/or bonding to satisfy the work requirements of the bid proposal

_____ Made efforts to expand the search for MWBE firms and Veteran-Owned businesses beyond the usual geographic boundaries.

_____ Other--any other evidence that the bidder submits which may show that the bidder has made reasonable good faith efforts to include MWDBE and Veteran participation.

NOTE: Failure to submit any of the documentation requested in this section may be cause for rejection of bid. Bidders may include any other documentation deemed relevant to this requirement which is subject to approval by the MBE Liaison. Documentation of Good Faith Efforts must be submitted with the Bid, if the participation Goal is not met.

The undersigned acknowledges that all information is accurate. Any misrepresentations may result in termination of the contract and/or be subject to applicable Federal and State laws concerning false statements and claims.

Lexington Truck Sales
Company

Danny R. Lyons
Company Representative

10/25/17
Date

General Sales Mng.
Title



LEXINGTON

Lexington-Fayette Urban County Government Division of Fleet Management Bid #143-2017 Cab & Chassis Truck with Front Loading Refuse Collection Body

The Lexington-Fayette Urban County Government is accepting bids to establish a price contract for Cab & Chassis Truck with Front Loading Refuse Collection Body for the Division of Fleet Management, 669 Bryd Thurman Drive, Lexington, Kentucky, as per the following specifications:

1.0 SCOPE OF BID

1.1 This specification describes the minimum requirements for a low entry, cab over, cab & chassis truck with front loading refuse collection body.

2.0 REQUIREMENTS

2.1 Engine and Drivetrain

2.2 Engine: **Cummins** engine displacement shall be not less than 725 cu. In. and specifically designed to operate on compressed natural gas (CNG). Engine shall be rated at no less than 330 horsepower and 1250 lb-ft. of torque. Engine manufacturer's warranty shall cover all internally lubricated components, gaskets, seals, fuel system parts, and electronic engine management components for a period of not less than 5 years, 150,000 miles, or 4,500 hours whichever occurs first. Complete description of engine warranty shall be provided in bid package.

2.3 Starting: Engine starter shall be 12 volt with overcrank protection.

2.4 Batteries: Maximum of three (3) AGM type 12-volt threaded post batteries providing a combined total of not less than 2400 CCA at 0° F. Jump start terminals shall be provided in a convenient location outside the battery enclosure. Battery enclosure shall include all available options to minimize corrosive damage to enclosure. A master battery disconnect shall be located on the outside of the battery enclosure with a pilot light indication of when the truck is energized.

2.5 Charging: Engine alternator shall have a rated output of not less than 180 amps.

2.6 Air Cleaner: Engine shall be equipped with a dry type air filter system with restriction indicator.

2.7 Cooling: Cooling system shall have external spin-on type coolant filter. Coolant shall be all-weather, extended life, providing antifreeze protection to -30° F. All coolant hoses shall be silicone rubber with hose clamps designed for use with silicone hose.

2.8 Engine Heater: Engine shall be equipped with 110-120 volt, 1500 watt immersion type pre heater. Engine heater receptacle shall be flush mounted on driver's (left) side of cab easily visible by person entering cab.

2.9 Engine Protection: Engine management system shall provide warning, and shutdown for conditions such as low engine oil pressure, high engine oil temperature, high coolant temperature, and low coolant level.

- 2.10 Exhaust: Unit shall have vertical exhaust system with chrome plated rain proof stack.
- 2.11 Transmission: Allison model 4500-RDS, six forward speeds with all electronic packages required by body manufacturer. Transmission shall be provided with Allison Extended Transmission Coverage (ETC) for a period of three (3) years beyond the standard warranty for a total warranty period of five (5) years. Transmission shall be filled with Allison TranSynd™ transmission fluid prior to delivery.

3.0 Chassis

- 3.1 Frame: Each frame rail shall have a RBM rating of not less than 3,000,000 in-lb. Frame shall have two front tow eyes installed. Front bumper shall be painted steel (black).
- 3.2 Wheel Base: As determined by body manufacturer.
- 3.3 Front Axle & Suspension: Front axle shall have a rated capacity of not less than 20,000 lbs. Front suspension and related components shall have a rated capacity of not less than 23,000 lbs. Front suspension shall include single overload cushions and shock absorbers.
- 3.4 Rear Axle & Suspension: Tandem rear axles and suspension shall have a rated capacity of not less than 46,000 lbs. Axle ratio shall provide a top speed of approximately sixty miles per hour (60 MPH).
- 3.5 Steering: Hydraulic power assisted, with power steering oil cooler.
- 3.6 Brakes: Brake system shall be air actuated disc type with severe service brake rotors and pads. Brake hoses shall be wire braid type. Air reservoirs shall be painted aluminum.
- 3.7 Air Dryer and Tanks: Brake system shall be equipped with a Bendix desiccant type air dryer. Air reservoirs shall be drained from a single point. Air brake system shall include a Schrader valve fill port for charging from an external compressed air source.
- 3.8 Tires & Wheels: Front wheels- 22.5" X 12.25" pilot mount steel disc (Accuride part number 29806PKBLK21). Front tires- 425/65R-22.5 load range L, Michelin XZY 3. Rear wheels- 22.5" X 8.25" pilot mount steel disc (Accuride part number 50408PKBLK21). Rear tires- Goodyear 12R22.5 G282 RSD load range H.

4.0 Cab and Fixtures

- 4.1 Cab: Tilt type cab, low entry, over engine design. Lowest step-up into cab shall be maximum eighteen (18) inches from ground level. Cab tilt/lift shall be air assisted. Front wheel openings shall have rubber flares installed. Extended rain gutters shall be installed over side window and door openings. Cab shall have a factory installed windshield guard.
- 4.2 Cab Fixtures: Driver's seat shall be air suspended with a durable cloth covering. All seating positions shall be equipped with a high visibility seat belt. Cab shall be equipped with an automotive type integrated air conditioner/heater/defroster with variable speed fan, and an AM/FM radio. Radio shall automatically mute when transmission is shifted into a reverse range.
- 4.3 Instruments: Cab shall include instrumentation for driver monitoring of coolant temperature, engine oil pressure, air pressure, fuel level (pressure), battery voltage, vehicle speed (MPH), engine speed (RPM), transmission oil temperature, alternator output (amps), miles traveled, and engine hours.

Warning lights shall be provided for low air pressure, low engine oil pressure, high coolant temperature, differential lock, and parking brake application.

- 4.4 Backup Alarm: Vehicle shall have an electronic backup alarm device installed. Alarm must meet OSHA requirements.
- 4.5 Mirrors: Power remote control, heated, west coast style with adjustable convex lower section, with an additional 8 inch convex mirror mounted below main mirror.
- 4.6 Horns: Dual electric horns. Single air horn mounted on cab bottom.
- 4.7 Fuel Tank: Diesel gallon equivalent (DGE) of ninety (90) gallons. (see section 11.0)
- 4.8 Paint: Frame shall be gloss black. Cab shall be finished with blue DuPont Imron Elite #44426. Bottom of cab shall be finished and undercoated.
- 4.9 Other Equipment: Vehicle shall retain all standard equipment unless specified or replaced by optional equipment.

5.0 Power Take-Off

- 5.1 Cab & chassis shall be designed to accept front mounting of a crankshaft driven hydraulic pump. Design shall allow PTO operation when cab is in a tilted position.

6.0 Body Construction

- 6.1 Payload Capacity: Net usable capacity shall be not less than 40 cubic yards.
- 6.2 Floor: Body floor shall be constructed of 3/16" abrasion resisting steel plate having a yield strength of not less than 100,000 PSI. Hopper floor shall be constructed of 1/4" abrasion resisting steel plate having a yield strength of not less than 155,000 PSI. The rear body floor shall be lower by four (4) inches to maintain a 100 gallon sump for liquid containment and to aid in load retention. Rear portion of body floor shall be curved similar to roof and sidewalls.
- 6.3 Body Sidewalls: Body sides shall be 3/16" abrasion resisting steel plate having a yield strength of not less than 100,000 PSI. Body shall have curved sidewalls to provide additional strength without additional exterior bracing.
- 6.4 Body Roof: Roof shall be curved and constructed of 10 gauge, abrasion resisting steel having a yield strength of not less than 100,000 PSI.
- 6.5 Tailgate: Tailgate shall be one piece, constructed of 10 gauge, not less than 100,000 PSI yield steel, hinged at top of body. Vertical and horizontal braces shall be 7 gauge, not less than 100,000 PSI yield steel. Raising, lowering, and latching of tailgate shall be done hydraulically. Tailgate opening shall include a rubber seal to prevent liquid seepage. Tailgate hinge points shall be structurally connected to boxed rear body posts such that a continuous load path is established between the tailgate hinges and the main structural elements of the body. An in-cab console mounted light and audible alarm shall be provided to indicate when the tailgate is not fully closed and locked.
- 6.6 Access Opening: The body shall have an opening, with door large enough to provide entry into the body. The door shall not open into the path of the lift arms. An interlock shall be provided to

instantly stop all hydraulic operations if the access door is opened. A stow-away step arrangement shall be provided for access to the door from the ground.

- 6.7 A liquid waste collection sump shall also be located in the forward end of the body. The sump shall have an easy access drain. The sump shall not drain directly onto any components of the truck, such as the battery box, air dryer, etc. Drain shall be constructed in such a way not to be hit by arm at any time.
- 6.8 Material retaining teeth or a step shall be located between the hopper and the body to prevent fall back of compacted material.
- 6.9 The volumetric size of the hopper shall be not less than ten cubic yards (10 yd³), and have a single cover that will completely close the hopper opening during compaction and travel. The hopper door shall be constructed of a minimum 12 gauge steel sheet with perimeter and center reinforcement. An interlock system shall be provided to prevent dumping a container when hopper door is closed. The hopper door shall slide open so as not to require any additional overhead clearance. The hopper opening shall be provided with wind-blown spillage protection.
- 6.10 Cab Protector: A steel 1 piece cab protector shall be an integral part of the body. The cab protector shall prevent material from falling between cab and the body and divert liquid spillage from the roof of the truck cab and from entering the truck windows. Cab protector design must allow for tilting of the cab and be well clear of the arms, forks, and container during loading operations.

7.0 Packing Mechanism

- 7.1 The packing mechanism shall be single blade design, hydraulically actuated, automatically sweeping the hopper and returning upon activation ("auto-pack"). Packing blade shall travel the full length of body (full ejection) for discharge of load. Interlock system shall prevent packing blade from traveling beyond the hopper unless tailgate is open.
- 7.2 Construction: All packing panel face material shall be at minimum 1/4" thick steel plate having a yield strength of not less than 100,000 PSI. Remainder of panel assembly shall be reinforced and constructed of materials suitable to withstand all compaction and ejection forces. Packing panel shall be supported by replaceable wear shoes riding on abrasion resistant steel tracks. Packing panel shoes shall be serviceable without removing the blade from the body.
- 7.3 Cycle Time: Maximum time for packing mechanism to clear hopper and return to forward position: 25 seconds.
- 7.4 Compaction: Indicate the average level of compaction attainable expressed in pounds per cubic yard. Minimum: 900 lbs. per yd³.

8.0 Lifting Mechanism

- 8.1 The body shall be equipped with a loader assembly having a capacity of not less than 10,000 lbs. Loader shall be designed to lift and dump the contents of an industry standard eight cubic yard (8 yd³) detachable container. The lift arms shall clear truck cab doors at all times to prevent trapping driver in truck cab.
- 8.2 Lift Arms: The lift arms shall be attached to a tubular shaft mounted on the forward end of the body. The shaft shall rotate in replaceable bushings. Shaft bushings shall be provided with grease fittings.

The lift arms shall be one piece, box type construction. Lift arms shall maintain a minimum clearance of 3 inches from truck cab throughout all phases of operation.

- 8.3 Fork Tines: A fork tine assembly shall be attached to the lifting arms by means of a tubular shaft. The shaft shall rotate in replaceable bushings provided with grease fittings. The fork tines shall have a retainer lug at each forward tip to prevent loss of a container during dump cycle. Fork tine operation shall be independent of the lift arms and shall be capable of achieving a position perpendicular to the street for travel. Fork tines shall be at least 1" thick, heat treated, structural quality alloy steel having a yield strength of not less than 100,000 PSI.
- 8.4 Interlock system shall be provided to prohibit dumping while packing blade is not in the forward position.
- 8.5 Arm Stops: Reinforced, bolt-on polyurethane arm stops shall be provided to cushion shock loads and prevent arm over-travel at the height of the loading sequence.
- 8.6 Cycle Time: Maximum time for lifting mechanism to raise, dump, and lower after container engagement: 20 seconds.

9.0 Hydraulic Controls

- 9.1 Controls: All body functions shall be controlled from inside the truck cab. Lift shall be operated by a single joystick type control. **Joystick control location shall be determined by Division of Solid Waste.** Push-pull cable controls will not be accepted. All body function controls shall be housed in a console or integrated into the truck cab. Push button controls with pilot lights shall be provided for automatic hopper sweep, eject, and retract functions of the packing mechanism. Controls shall be clearly marked as to their function. A warning light shall be provided to indicate when the tailgate is not down and latched and to indicate the status of the hopper door. All sensors required for proper body function shall be sealed proximity type. Control panel shall include an "auto-pack" switch; when activated, the compactor panel will complete one (1) packing cycle. An "Emergency STOP" button shall be included which will interrupt all hydraulic flow. Mechanical limit switches will not be accepted, including sensors for all safety warning circuits.
- 9.2 Hydraulic Pump: Hydraulic pump shall be primarily constructed of cast iron and/or steel.
- 9.3 Hydraulic Tank: Tank shall be of sufficient capacity to allow repeated cycling without overheating hydraulic oil. Tank shall be provided with an internally mounted suction screen with service access, return line filter with spin-on element, electrical by-pass indicator, shut-off ball valve, and screened fill port. All tank venting shall be filtered. Tank shall have a temperature gauge and an oil sight gauge with a minimum length of 5 inches.
- 9.4 Overspeed Protection: A mechanical or electronic method shall be incorporated to protect the hydraulic pump from damage due to an overspeed condition. Electronic solutions shall utilize the existing management system(s) of the truck. External electronic overspeed systems will not be accepted.
- 9.5 Valve Bank: No cable operated valves will be accepted. Hydraulic system shall have adjustable main relief valve. A pressure gauge measuring main system pressure shall be installed in close proximity to main relief adjustment.

9.6 Hydraulic Plumbing: Welded steel tubing shall be used wherever possible secured by cushioned clamps. All hydraulic hose shall meet or exceed SAE 100R2 Type AT requirements and shall be protected by protective nylon sock. No hose clamp connections will be accepted.

10.0 Miscellaneous

10.1 The frame rails of the truck shall not be drilled, cut, or altered in any way other than that approved by the chassis manufacturer.

10.2 Anti-sail mud flaps shall be installed behind rear wheels.

10.3 Lighting: All lighting required by the Federal Motor Vehicle Safety Standard #108, shall be installed. Headlights shall be LED. All rear facing stop, turn, or tail lamps shall be flush mounted, sealed LED units. All clearance lamps shall be grommet mounted sealed LED units. License plate lamp shall be a sealed LED unit. Backup lamps shall be sealed LED units. One (1) sealed LED lamp shall be used to illuminate the area in front of the ejector panel and controlled by a switch in truck cab.

10.4 Strobe Lights: Two (2) rear facing four inch (4") round, grommet mounted, amber strobe lights shall be mounted on the tailgate in a manner consistent with other rear facing lights. All strobe lights shall be grommet mounted, amber in color, self-contained LED units. Strobe box systems will not be accepted.

10.5 Wiring: Any circuit added to the truck requiring fuse protection shall be wired through the truck's fuse panel. All connections to a component shall be made with a molded plug or otherwise environmentally sealed connector. Individual wires shall be terminated with a terminal which is crimped, soldered, and covered with heat shrink tubing. Splices should be avoided. If a spliced wire cannot be avoided, the splice shall be soldered and covered with heat shrink tubing. Under no circumstances will the use of the following items or methods be accepted: crimp-type butt connectors, Scotchlok™s, solderless terminals, electrical tape, wire nuts, in-line fuses. All wiring shall be encased in protective flexible loom.

10.6 Painting/Coating: Entire body shall be thoroughly cleaned of dirt, oil, grease, and welding slag prior to painting or coating. No electrical wire, hydraulic hose, hose end fitting or other hydraulic fittings shall be painted or coated. Body to be metallic gray (DuPont Imron Elite 44400U). Bid package shall include thorough description of painting or coating process and any warranty provided.

10.7 Safety Equipment: A 10 lb. fully rechargeable, A-B-C fire extinguisher shall be mounted on the outside of the driver's side of packer body in a convenient location. A set of reflecting safety triangles shall be provided. Caution signage similar to illustration below shall be installed on tailgate:



10.8 Back-Up Vision System: A multi-view (Pro-Vision) closed circuit vision system utilizing four (4) color cameras and a color multi-view LCD monitor positioned for convenient viewing by driver shall be

installed. System shall automatically activate when truck is in reverse gear or may be manually activated. Cameras shall be protected by a stainless steel cage. Camera views shall provide a view of the area immediately behind the center of the truck; the area to the right rear of the truck, and a view of the container dump area above the cab and also inside hopper area. Vision system components shall be provided with a five (5) year warranty (Pro-Vision). **Pro-Vision is the only system accepted.**

- 10.9 Finished Overall Height: Bid package must state the overall finished height of the unit. Bid packages failing to state finished height cannot be evaluated. Finished heights in excess of thirteen feet (13') may be rejected.
- 10.10 Cylinder Attachment: Hydraulic cylinder attachment pins shall be drilled and taped such that pulling equipment can be used to facilitate their removal. Pins retained by removable saddles are exempt from this requirement.
- 10.11 AutoLube System: A Lincoln Quicklube® On Board Grease System shall be installed to service all critical points of lubrication on the refuse body. All hoses and components shall be installed in a manner where there will be no inference with body or chassis components or operations.
- 10.12 Tool box: A weatherproof stainless steel tool box (Bawer #TU826500) shall be installed under the right side of truck, mounted on truck frame.
- 10.13 Unit Graphics: Graphics designed and furnished by the LFUCG shall be installed on body.

11.0 Compressed Natural Gas

- 11.1 Unit shall be provided with a compressed natural gas fuel system with a capacity of not less than the equivalent of ninety (90) diesel gallons (DGE). Fuel tank(s) shall be appropriately protected from damage caused by vehicle collision or other calamity. System shall include both a fast and slow fill port conveniently located on drivers side, a maintenance defueling port, and an interlock to prevent engine start unless fill hoses have been disconnected. Additional fast and slow fill fueling ports shall be provided in the front bumper. Pressure sending unit capable of driving the chassis OEM fuel gauge, shall be installed. Routing of fuel lines to fuel storage cylinders shall not be exposed on side of body, but must be routed through and protected by steel raceways built into the structure of the body.
- 11.2 Methane Detection: Each unit shall have a dual zone methane detection system installed with sensors located in the engine compartment and inside the truck cab.

12.0 NOTES

12.1 Testing and Inspection

- 12.1.1 Each unit furnished shall be physically inspected by LFUCG personnel prior to acceptance. Appropriate measures will be taken to insure compliance with specifications; unit(s) will be checked for completeness and functionality. All equipment, standard and specified, shall be installed and tested prior to delivery. Failure to meet any aspect of this specification for which an exception was not taken may be grounds for refusal of delivery and/or payment.

12.2 Delivery

12.2.1 Completed vehicle(s) shall be delivered and titled to LFUCG Division of Fleet Services facility located at 669 Byrd Thurman Drive, Lexington, Kentucky. Units shall be ready to work upon delivery.

12.3 Literature

12.3.1 Manufacturer's literature which shall include complete specifications and warranty shall be included with bid and becomes integral part of bid. All literature submitted shall be original printed material- no photocopied material. Any modifications which may be necessary to meet specifications must be listed in writing and submitted as integral part of bid.

12.4 Method of Award

12.4.1 A price contract shall be awarded to the responsive and responsible bidder who has demonstrated the capability to best comply with the requirements contained herein at the lowest unit price. The price contract price shall remain in effect for one (1) year after date of award with an option to re-new for one (1) additional year if agreed by both parties. Adequately documented price adjustments may be considered at time of renewal.

13.0 General

13.1 All equipment furnished shall be new and unused, current model production.

13.2 Training: Manufacturer's representative shall spend a minimum of two (2) days instructing LFUCG mechanics and operators in the maintenance and operation of the equipment provided. One (1) day for LFUCG mechanics and one (1) day for operators. Training shall include the cab & chassis, packer body and the CNG fuel system.

13.3 Successful bidder shall provide one (1) repair manual and one (1) parts manual with each group of units delivered. Electronic delivery or internet access to parts and service manuals is acceptable. Each unit shall be provided with a printed operator's manual. All manuals shall be original printed editions. A vehicle line-sheet shall be provided for each chassis. All items listed in this paragraph shall be supplied at time of delivery of each unit.

13.4 Warranty Repairs: (Applies to entire unit) If the vendor providing warranty service for any portion of unit(s) described herein whose repair facility is in excess of fifteen (15) miles from the LFUCG Fleet Services facility, at the vendor's option, warranty repairs may be performed at the vendor's location provided vendor picks up the vehicle within 24 hours of notification and returns vehicle upon completion of repairs. When vendor elects this option, all transportation expenses shall be included in the warranty coverage. In the interest of reduced downtime, the Division of Fleet Services may be designated a warranty repair shop. An in-house warranty agreement shall include reimbursement or credit for parts at 100% of their cost and labor at a rate of eighty three dollars (\$83.00) per hour. If the manufacturer publishes a time table for standard repair operations, one will be furnished and used to determine billable labor. If such a standard does not exist, vendor agrees to reimburse labor as recorded on LFUCG repair orders (actual time). Vendor shall furnish any forms the manufacturer may require for warranty return parts. LFUCG will invoice vendor for warranty repairs during the warranty period. Vendor shall agree to accept LFUCG repair orders as evidence of work performed.

13.5 References: If specific model bid is not currently in use by the LFUCG; upon request, bidder shall provide a list of at least five (5) users of the exact model bid.

EXCEPTION PAGE

Paragraph Number	Description of Exception
	E-Z Pack Mfg complies to all body specifications and requirements.
2.4	Battery disconnect, outside marker light will be on if switch is in on position
2.7	No coolant Filter provided
3.3	Front suspension is rated @ 22,000 lb.
4.1	Front Fender extensions are poly type Not rubber
	Exhaust pipe is stainless steel
	due to heat

Warranty Description

Basic Vehicle Warranty (cab & chassis)	Length of Warranty Period (time, mileage, etc.)	Warranty Provided By:	Vendor agrees to warranty terms stated in paragraph 13.4?
	12 mo./100,000 miles	Autocar	Yes / No
Basic Warranty (body)	Length of Warranty Period (time, mileage, etc.)	Warranty Provided By:	Vendor agrees to warranty terms stated in paragraph 13.4?
	12 Month	E-Z Pack Mfg	Yes / No
Engine Warranty (paragraph 2.2)	Length of Warranty Period (time, mileage, etc.)	Warranty Provided By:	Vendor agrees to warranty terms stated in paragraph 13.4?
	5 yr./150,000 miles	Cummins	Yes / No
Transmission Warranty (paragraph 2.11)	Length of Warranty Period (time, mileage, etc.)	Warranty Provided By:	Vendor agrees to warranty terms stated in paragraph 13.4?
	5 year	Allison	Yes / No
Exterior Finish Warranty (body)	Length of Warranty Period (time, mileage, etc.)	Warranty Provided By:	Vendor agrees to warranty terms stated in paragraph 13.4?
	12 Month	E-Z Pack Mfg	Yes / No
Hydraulic Pump Warranty (paragraph 9.2)	Length of Warranty Period (time, mileage, etc.)	Warranty Provided By:	Vendor agrees to warranty terms stated in paragraph 13.4?
	24 Month	E-Z Pack Mfg.	Yes / No
Hydraulic Cylinder Warranty (body)	Length of Warranty Period (time, mileage, etc.)	Warranty Provided By:	Vendor agrees to warranty terms stated in paragraph 13.4?
	12 Month	E-Z Pack Mfg.	Yes / No

Back-Up Vision System Warranty (paragraph 10.8)	Length of Warranty Period (time, mileage, etc.)	Warranty Provided By:	Vendor agrees to warranty terms stated in paragraph 13.4?
	5 Year	E-Z Pack Mfg. and ProVision	Yes / No

Other Information

Packer Performance	Clear Hopper Cycle Time (paragraph 7.3)	Load Sequence Cycle Time (paragraph 8.7)	Compaction (paragraph 7.4)
	35 seconds – Forward and Back	20 Seconds Up and Down	900 lbs. per yd ³ .

Exterior Finish (paragraph 10.6)	Describe painting or coating system for the exterior surfaces of the body.
	See Attached Information

Finished Overall Height (paragraph 10.9)	Measured height from the ground to the highest point of finished unit.	The LFUCG Division of Waste Management will have final approval of finished vehicle height. Stated heights in excess of thirteen feet (13') may be cause for rejection. Any unit whose measured height upon delivery exceeds that stated herein will not be accepted.
	With Arms in the lowered position – 12'11"	

**RISK MANAGEMENT PROVISIONS
INSURANCE AND INDEMNIFICATION**
Bid #143-2017 Cab & Chassis Truck with Front Loading Refuse Collection Body

INDEMNIFICATION AND HOLD HARMLESS PROVISION

- (1) It is understood and agreed by the parties that Vendor hereby assumes the entire responsibility and liability for any and all damages to persons or property caused by or resulting from or arising out of any act or omission on the part of Vendor or its employees, agents, servants, owners, principals, licensees, assigns or subcontractors of any tier (hereinafter "Vendor") under or in connection with this agreement and/or the provision of goods or services and the performance or failure to perform any work required thereby.
- (2) Vendor shall indemnify, save, hold harmless and defend the Lexington-Fayette Urban County Government and its elected and appointed officials, employees, agents, volunteers, and successors in interest (hereinafter "LFUCG") from and against all liability, damages, and losses, including but not limited to, demands, claims, obligations, causes of action, judgments, penalties, fines, liens, costs, expenses, interest, defense costs and reasonable attorney's fees that are in any way incidental to or connected with, or that arise or are alleged to have arisen, directly or indirectly, from or by Vendor's performance or breach of the agreement and/or the provision of goods or services provided that: (a) it is attributable to personal injury, bodily injury, sickness, or death, or to injury to or destruction of property (including the loss of use resulting therefrom), or to or from the negligent acts, errors or omissions or willful misconduct of the Vendor; and (b) not caused solely by the active negligence or willful misconduct of LFUCG.
- (3) In the event LFUCG is alleged to be liable based upon the above, Vendor shall defend such allegations and shall bear all costs, fees and expenses of such defense, including but not limited to, all reasonable attorneys' fees and expenses, court costs, and expert witness fees and expenses, using attorneys approved in writing by LFUCG, which approval shall not be unreasonably withheld.
- (4) These provisions shall in no way be limited by any financial responsibility or insurance requirements, and shall survive the termination of this agreement.
- (5) LFUCG is a political subdivision of the Commonwealth of Kentucky. Vendor acknowledges and agrees that LFUCG is unable to provide indemnity or otherwise save, hold harmless, or defend the Vendor in any manner.

FINANCIAL RESPONSIBILITY

Vendor understands and agrees that it shall demonstrate the ability to assure compliance with these provisions prior to final acceptance of its bid and the commencement of any work or the provision of any goods.

INSURANCE REQUIREMENTS

YOUR ATTENTION IS DIRECTED TO THE INSURANCE REQUIREMENTS BELOW. YOU MAY NEED TO CONFER WITH YOUR INSURANCE AGENTS, BROKERS, OR CARRIERS TO DETERMINE IN ADVANCE OF SUBMISSION OF A RESPONSE THE AVAILABILITY OF THE INSURANCE COVERAGES AND ENDORSEMENTS REQUIRED HEREIN. IF YOU FAIL TO COMPLY WITH THE INSURANCE REQUIREMENTS BELOW OR THE INDEMNITY REQUIREMENTS, YOU MAY BE DISQUALIFIED FROM AWARD OF THE CONTRACT.

Required Insurance Coverage

Vendor shall procure and maintain for the duration of this contract the following or equivalent insurance policies at no less than the limits shown below and cause its subcontractors to maintain similar insurance with limits acceptable to LFUCG in order to protect LFUCG against claims for injuries to persons or damages to property which may arise from or in connection with the performance of the work or provision of goods hereunder by Vendor. The cost of such insurance shall be included in any bid:

<u>Coverage</u>	<u>Limits</u>
General Liability (Insurance Services Office Form CG 00 01)	\$1 million per occurrence, \$2 million aggregate or \$2 million combined single limit
Commercial Automobile Liability (Insurance Services Office Form CA 0001)	combined single limit, \$1 million per occurrence
Worker's Compensation	Statutory
Employer's Liability	\$1,000,000

The policies above shall contain the following conditions:

- a. All Certificates of Insurance forms used by the insurance carrier shall be properly filed and approved by the Department of Insurance for the Commonwealth of Kentucky. LFUCG shall be named as an additional insured in the General Liability Policy and Commercial Automobile Liability Policy using the Kentucky DOI approved forms.
- b. The General Liability Policy shall be primary to any insurance or self-insurance retained by LFUCG.
- c. The General Liability Policy shall include Products Liability coverage unless it is deemed not to apply by LFUCG.
- d. The Policy shall include Umbrella/Excess Liability coverage in the amount of \$5 million per occurrence, \$5 million aggregate, unless it is deemed not to apply by LFUCG.
- e. LFUCG shall be provided at least 30 days advance written notice via certified mail, return receipt requested, in the event any of the required policies are canceled or non-renewed.
- f. Said coverage shall be written by insurers acceptable to LFUCG and shall be in a form acceptable to LFUCG. Insurance placed with insurers with a rating classification of no less than Excellent (A or A-) and a financial size category of no less than VIII, as defined by the most current Best's Key Rating Guide shall be deemed automatically acceptable.

Renewals

After insurance has been approved by LFUCG, evidence of renewal of an expiring policy must be submitted to LFUCG, and may be submitted on a manually signed renewal endorsement form. If the policy or carrier has changed, however, new evidence of coverage must be submitted in accordance with these Insurance Requirements.

Deductibles and Self-Insured Programs

IF YOU INTEND TO SUBMIT A SELF-INSURANCE PLAN IT MUST BE FORWARDED TO LEXINGTON-FAYETTE URBAN COUNTY GOVERNMENT, DIVISION OF RISK MANAGEMENT, 200 EAST MAIN STREET, LEXINGTON, KENTUCKY 40507 NO LATER THAN A MINIMUM OF FIVE (5) WORKING DAYS PRIOR TO THE RESPONSE DATE. Self-insurance programs, deductibles, and self-insured retentions in insurance policies are subject to separate approval by Lexington-Fayette Urban County Government's Division of Risk Management, upon review of evidence of Vendor's financial capacity to respond to claims. Any such programs or retentions must provide LFUCG with at least the same protection from liability and defense of suits as would be afforded by first-dollar insurance coverage.

Verification of Coverage

Vendor agrees to furnish LFUCG with all applicable Certificates of Insurance signed by a person authorized by the insurer to bind coverage on its behalf prior to final award, and if requested, shall provide LFUCG copies of all insurance policies, including all endorsements.

Right to Review, Audit and Inspect

Vendor understands and agrees that LFUCG may review, audit and inspect any and all of its records and operations to insure compliance with these Insurance Requirements.

DEFAULT

Vendor understands and agrees that the failure to comply with any of these risk management provisions shall constitute a default and that LFUCG may elect at its option any single remedy or penalty or any combination of remedies and penalties, as available, including but not limited to purchasing insurance and charging Vendor for any such insurance premiums purchased, or suspending or terminating the contract or work.

00518603

12 Liter

10/26/2017

GAWR, GVWR & Tire Pressure

GVW Rating – 66,000#			
Front GAWR	20,000#	Rear GAWR	46,000#
Front Suspension	22,000#	Rear Suspension	46,000#
Front Wheels	22,800#	Rear Wheels	59,100#
Front Tire Size And Tread	22,800#	Rear Tire Size And Tread	54,200#
Front Brakes	20,000#	Rear Brakes	46,000#
Front Axle	22,000#	Rear Axle	46,000#
PSI			
Front PSI	110.0	Rear PSI	95.0

10/26/2017

Chassis Specification

		Description	Front Weight	Rear Weight	Price
AUTOCAR TRUCKS					
O	ENG0001	ENGINEERING GROUP IDENTIFIER	AUTOCAR ENGINEERING	0	0
S	0040002	MODELS	ACX64	10,431	6,154
S	5000001	CAB SHELL	SINGLE LEFT HAND DRIVE CAB	0	0
O	100U001	CUSTOMER TYPE	MUNICIPAL	0	0
VEHICLE ADAPTATION					
S	114010	COUNTRY OF USE	UNITED STATES STD MARKET ADAPTATION	0	0
SOLUTION					
A	C04QXX	BODY COMPANY	EZ Pack	0	0
O	C01003	APPLICATION	REFUSE - LANDFILL	0	0
O	C02001	BODY TYPE	COMMERCIAL FRONT END LOADER	0	0
O	C03003	TERRITORY	CENTRAL	0	0
O	C06901	BODY STYLE	E-Z PACK HERCULES	0	0
O	C05040	TOTAL BODY CAPACITY - BODY/HOPPER	40 YARD	0	0
O	C070002	FUEL SYSTEM TYPE	GAS/CNG/BODY MOUNTED TANKS	0	0
O	C080001	REAR SUSPENSION TYPE	STD/BEAM TYPE REAR SUSPENSION	0	0
O	C090003	AXLE QUANTITY	3 AXLE	0	0
O	D010200	FRONT GAWR	20000 LBS	0	0
O	D020460	REAR GAWR	46000 LBS	0	0
O	D100660	GVWR	66000 LBS	0	0
O	ALLI299	ALLISON iSCAAN	iSCAAN PASSED	0	0
ENGINE					
S	1580001	ENGINE VOCATION	COMMERCIAL - DOMESTIC (DOT)	0	0
O	1012020	ENGINE ASSY	ISX12N, '18 330 HP @ 2100 / 1250 LB-FT, CUMMINS	0	0
O	4460002	FUEL TYPE	COMPRESSED NATURAL GAS	0	0
O	972A002	SPECIAL EMISSION CERTIFICATION LABELS	49 STATE-NO LABEL REQUIRED	0	0
ENGINE EQUIP					
O	122002	PTO-ENGINE FRONT	ADAPTER FOR SPICER 1350	40	-9

S	128071	ENGINE CONTROL SPECIFICATIONS	DEFAULT SPECS	0	0
O	1290004	ENGINE ELECTRONICS	CUMMINS 500K COMMUNICATION	0	0
S	132034	ENGINE PROTECT SYSTEM/WARNINGS	AUDIBLE/VISUAL ALARM/LOP, HT, LWL	0	0
O	438998	FILTER-FUEL, CHASSIS MOUNTED	NO ADDITIONAL FUEL FILTER PROVIDED	-3	0
O	170104	FILTER-FUEL, ENGINE MOUNTED	NATURAL GAS FUEL CLEANER	0	0
S	1750001	ENGINE OIL	STANDARD ENGINE OIL	0	0
O	180021	ENGINE BLOCK HEATER	PHILLIPS 120V 1500W	5	0
O	1810004	HEATER RECEPTICAL LOCATION-ENGINE	RECEPTACLE LOCATED AT CAB STEPS, LH SIDE	1	0
S	2000004	RADIATOR	1300 SQ. IN., 2-ROW HIGH CAPACITY ALUMINUM	0	0
S	2080001	FAN & DRIVE-ENGINE	2-SPEED FAN	0	0
S	2090001	RADIATOR COOLANT	EXTENDED LIFE COOLANT	0	0
O	2120003	RADIATOR SURGE TANK	STANDARD SURGE TANK W/ SIGHT GLASS	0	0
S	2200001	AIR CLEANER	15" ONE STAGE EPG CLEANER DONALDSON	0	0
S	226001	AIR INTAKE RAIN CAP	BLACK, HOOD TYPE	0	0
O	2300012	MUFFLER SYSTEM	HORZ CATALYST W/ RH VERT OUTLET	0	0
O	2310002	EXHAUST SHIELDS	STAINLESS STEEL HORZ MUFF SHIELD-SINGLE	0	0
S	2320003	EXHAUST STACKS	VERTICAL DIFFUSER, SINGLE STAINLESS STEEL	0	0
O	115A200	TURBO HEAT SHIELD	TURBO HEAT SHIELD	0	0
O	239998	UREA DELIVERY SYSTEM	NO DEF TANK PROVIDED	-30	-4
S	5300001	ENGINE/EXHAUST COVER	ALUM TURBO/EXHAUST PIPE DEBRIS SHIELD	0	0
S	700026	AIR COMPRESSOR	CUMMINS WABCO 18.7 CFM COMPRESSOR	0	0
S	8200003	STARTING MOTOR	DELCO REMY 12V 39 MT W/OCP	0	0
O	8020005	ALTERNATOR	DELCO REMY 180 AMP, 28SI PAD MTD.	5	0
S	P010065	VEHICLE GOVERNED SPEED LIMIT	SPEED LIMIT 65MPH	0	0
S	P020001	ENGINE IDLE SHUT DOWN	ENGINE IDLE SHUT DOWN ENABLED (5 MINUTES)	0	0
S	P030001	CRUISE CONTROL PARAMETER	CRUISE CONTROL ENABLED	0	0
S	P110000	PTO REGEN INHIBIT THRESHOLD	PTO REGEN INHIBIT THRESHOLD = 0 MPH	0	0
S	P641200	RPM PTO MODE	1200 RPM MAX IN PTO	0	0

S	P701200	PTO SET SWITCH	PTO SET SWITCH = 1200 RPM	0	0
S	P711000	PTO RESUME SWITCH	PTO RESUME SWITCH = 1000 RPM	0	0
S	P730500	PTO RAMP RATE INCREMENT	PTO RAMP RATE INCREMENT = 500 RPM	0	0
S	P830000	IGNORE VSS IN PTO MODE	IGNORE VSS IN PTO MODE = DISABLED	0	0

TRANSMISSION

S	2580003	VOCATION	RDS REFUSE - VOC 400-XXX	0	0
S	2690014	CONTROL MODULE (ELECT)	REFUSE W/ AUTO-NEUTRAL, VP142	0	0
S	26A0001	TRANSMISSION SHIFT SCHEDULE / FUEL SENSE	PRIMARY PERFORMANCE / SECONDARY ECONOMY	0	0
S	27P0000	TRANSMISSION RETARDER AUDIBLE ALARM	NO TRANSMISSION RETARDER AUDIBLE ALARM	0	0
O	2700028	TRANSMISSION	ALLISON 4500 SERIES,6-SPEED	384	59
S	284016	TRANSMISSION CONTROLS	ALLISON PUSHBUTTON CONTROLS	0	0
S	286005	COOLER-TRANSMISSION OIL	OIL TO WATER TYPE	0	0
O	2900004	TRANSMISSION OIL FILL/CHECK	TRANS FLUID WITH DIPSTICK AND THREADED OIL SAMPLE PORT	1	0
S	292004	TRANSMISSION LUBRICANT	TRANSYND SYNTHETIC AUTO TRANS FLUID	0	0
O	300013	DRIVESHAFT-MAIN	SPICER 1810HD HALF ROUND	5	10

FRONT AXLE

O	3700011	FRONT AXLE	DANA D-2200W STEER AXLE, 22,000 LB CAPACITY	0	0
S	3690005	FRONT AXLE POSITION	52.5 INCHES	0	0
O	3710003	FRONT SUSPENSION	10200 LB TAPER LEAF REDUCED RIDE HEIGHT, 22000 LB GROUND CAPACITY	-90	5
O	371T01	SUSPENSION, FRONT AUX	AUX LOAD CUSHION	10	0
S	373002	SHOCK ABSORBERS-FRONT	DOUBLE ACTING SINGLE - HEAVY DUTY	0	0
S	904011	HUBS-FRONT	STEEL HUB PILOTED,285MM BOLT CIRCLE	0	0
O	9409996	WHEEL OIL SEALS-FRONT	SUPPLIED WITH DRESSED DISC BRAKE AXLE, CHICAGO RAWHIDE	0	0
O	9210002	HUB CAPS - FRONT AXLE	STEMCO TRADITIONAL, ALUM.	-1	0
O	374002	FRONT AXLE LUBRICANT	SYNTHETIC,DANA SPICER EP75W90,OR EQUIV	0	0

O	7510011	BRAKES-FOUNDATION, FRONT AXLE	MERITOR EX - 225 AIR DISC BRAKES XXXX	0	0
O	755998	DUST SHIELDS - FRT BRAKES	NO FRONT BRAKE DUST SHIELDS PROVIDED	-1	0
O	9010003	BRAKE DRUM-FRONT	ROTORS - CAST IRON, VENTED, INBOARD MTD	0	0
S	383101	STEERING GEAR	INTEGRAL POWER STEERING W/RIGHT HAND RAM	0	0
U	383QXX	STEERING GEAR	POWER STEERING COOLER	0	0
S	387003	POWER STEERING RESERVOIR	FOUR QUART REMOTE MOUNTED	0	0

REAR AXLE

O	330444	REAR DRIVE AXLE-SINGLE & TANDEM	MERITOR RT46-160 46,000 LB	0	430
S	330U98	REAR AXLE LUBE PUMP	NO LUBRICATION PUMP	0	0
O	331538	REAR DRIVE AXLE RATIO	5.38	0	0
O	3500004	REAR SUSPENSION	HENDRICKSON HMX-460 SUSP @ 54" AS	0	0
S	351013	REAR SUSPENSION BEAMS	54 INCH STEEL RUBBER BUSHED	0	0
S	358005	TORQUE RODS	LONGITUDINAL & TRANSVERSE - RUBBER BUSHED	0	0
S	9130001	HUBS-REAR	IRON HUB, HP 10 STUD	0	0
S	3400001	REAR AXLE BREATHER	STANDARD AXLE BREATHER	0	0
O	9419996	WHEEL OIL SEALS-REAR	SUPPLIED WITH DRESSED DISC BRAKE AXLE, NATIONAL	0	0
O	339002	REAR AXLE LUBRICANT	SYNTHETIC	0	0
O	7610011	BRAKES-FOUNDATION, REAR AXLE	MERITOR EX - 225 AIR DISC BRAKES XXXX	0	-150
O	765998	DUST SHIELDS - REAR BRAKES	NO REAR AXLE DUST SHIELDS PROVIDED	0	-2
O	7810002	BRAKE CHAMBERS-PARKING, TYPE/VENDOR	STANDARD - DISC BRAKES	0	0
O	9100003	BRAKE DRUM-REAR	ROTORS - CAST IRON, VENTED, INBOARD MTD.	0	0

BRAKES

S	729002	AIR LINES-PARKING BRAKE, CHASSIS	AIR LINES CHASSIS PARK BRAKE	0	0
S	741047	BRAKE CONTROL SYSTEM	BENDIX ABS 4S/4M	0	0

CHASSIS

O	400204	WHEELBASE	204 INCHES	-7	-8
S	402104	FRAME-REAR OVERHANG	104"	0	0
S	403012	FRAME RAILS	3/8" VARIABLE DROP STEEL, EXT B	0	0

X	4090001	FRAME CROSSMEMBER-CENTER	7-PIECE STEEL W/ ALUM BOC X-MEMBER	22	118
S	4110002	FRAME CROSSMEMBER-END CLOSING	ALUMINUM MEMBER-IF REQUIRED	0	0
S	4120002	FRAME BOLTS	HUCKSPIN RR SUSP & CROSSMEMBERS	0	0
S	460001	BUMPER-FRONT	STEEL PAINTED	0	0
O	4680010	GUARD-OIL PAN	ENGINE OIL PAN GUARD - ALUMINUM	49	-6
S	480002	TOWING DEVICE-FRONT	TWO REMOVABLE TOW PINS	0	0
O	8742000	WIRING, BODY INTERFACE	RP 170 COMPLIANT	0	0
O	430998	FUEL TANK-LEFT	DELETE LHS FUEL TANK	-29	-59
O	436023	FUEL LINES	STAINLESS STEEL FOR CNG OR LNG (FILTER TO ENGINE)	0	0
O	4200002	ALTERNATE FUEL SYSTEMS	METHANE DETECTION SYSTEM	5	0
S	8120005	BATTERY BOX	STEEL BOX, 3 BATTERY, LHS	0	0
O	8160005	BATTERY BOX SPACERS	BATTERY BOX SPACED 2", DROPPED 6"	5	1
S	8090001	BATTERY BOX DRILLING	BOX LOCATED AS FAR FORWARD AS POSSIBLE	0	0
O	810092	BATTERY	3 JOHNSON CONTROL 31ECL 12V 2850CCA	7	3
O	8140003	BATTERY SHUT-OFF SWITCH	SHUTOFF W/ LOCKOUT & EMERGENCY JUMPER STUDS	5	2
O	7110002	AIR TANK-BRAKE	ALUMINUM AIR TANKS	-15	-31
S	7090002	AIR TANK DRILLING	AIR TANKS IN STANDARD POSITION	0	0
O	7380001	EMERGENCY AIR SYSTEM CHARGING	SCHRADER VALVE, WET TANK MTD	1	0
S	715002	WET TANK DRAIN	BENDIX D/V-2 AUTOMATIC	0	0
O	715T003	AIR RESERVOIR DRAIN SYSTEM	CENTRAL MANIFOLD W/ PETCOCKS	2	2
O	713023	AIR DRYER	BENDIX ADIP W/HEAT	0	0
S	7100003	AIR DRYER DRILLING	AIR DRYER MOUNTED OUTSIDE RAIL, LHS	0	0
S	724001	AIR LINES-CAB	SAE J844 NYLON TUBING	0	0
S	728001	AIR LINES-MAIN, CHASSIS	SAE J844 NYLON TUBING	0	0

CAB EXTERIOR

S	4510001	STEP-CAB ACCESS, CAB MOUNTED	DUAL SELF CLEANING CAB ENTRANCE STEPS	0	0
S	462004	MUD FLAPS-FRONT WHEEL	FRONT FLAPS	0	0
S	502001	CAB DOORS	STEEL	0	0
O	502T03	DOOR CHECK STRAPS	L.H. & R.H. DOOR CHECK STRAP	2	0
O	5140001	CAB GUARD FRONT	XPEDITOR CAB GUARD	27	-8

S	622C200	MIRROR PANE QUANTITY	DUAL PANE MIRROR	0	0
O	6220017	MIRRORS-DUAL WEST COAST	MIRROR, BLACK, HTD, REMOTE W / LWR HTD CONVEX	0	0
S	6190002	MIRROR ARMS	RETRACTABLE ARMS, STAINLESS STEEL	0	0
O	6230006	MIRRORS-AUXILIARY	HIGH MOUNT 8" CONVEX, BLACK	0	0
O	618998	DOWN VIEW MIRRORS	NO DOWN VIEW MIRRORS PROVIDED	-2	0
S	6240001	GRAB HANDLES-ENTRY	BRUSHED SS GRAB HANDLES	0	0
S	630026	HORN-AIR	TWIN MOUNTED UNDER CAB	0	0
O	631002	HORN-ELECTRIC	DUAL	1	0
O	661002	CAB TILT MECHANISM-C.O.E.	HYDRAULIC TILT WITH AIR ASSIST	20	0
S	6720001	GRILLE	AUTOCAR GRILLE	0	0
S	675001	BUG SCREENS	BUG SCREEN MOUNTED BEHIND GRILLE	0	0
S	6910001	FENDER EXTENSIONS-FRONT	IMPACT RESISTANT POLY FENDER	0	0

CAB INTERIOR

S	3800001	STEERING WHEEL	16" DIA. WHEEL, 2 SPOKE	0	0
O	3810002	STEERING COLUMN	TILT AND TELESCOPIC STEERING COLUMN	0	0
S	520234	SEAT-DRIVER	NATIONAL CUSH II LOW BACK, AIR RIDE	0	0
S	521110	SEAT-PASSENGER	FIXED TYPE, LOW BACK	0	0
O	5220002	SEAT BELTS-DRIVER	THREE POINT RETRACTABLE, BRIGHT ORANGE COLOR	0	0
O	5230002	SEAT BELTS-PASSENGER	THREE POINT RETRACTABLE, BRIGHT ORANGE COLOR	0	0
S	526014	SEAT INSERT	BLACK CORDURA	0	0
S	538001	CARPET & MAT	MAT WITH FOAM BACK	0	0
S	5390001	CAB INTERIOR	AUTOTUFF INTERIOR UPHOLSTERY	0	0
S	5500001	CENTER CONSOLE	CENTER CONSOLE	0	0
O	5510002	REAR CONSOLE	REAR CONSOLE W/ WIRE FRAME STORAGE CONTAINER	2	0
S	5930001	ASH TRAY	ASHTRAY MTD IN CONSOLE	0	0
O	8750001	ADDITIONAL ELEC. SWITCHES	2 DASH SWITCHES, WIRED TO POWER	1	0

CAB CLIMATE CONTROL

S	060001	CAB TEMPERATURE SYSTEM	AIR COND INTEGRAL WITH HEATER/DEFROSTER	0	0
---	--------	------------------------	-----------------------------------------	---	---

O	612001	AIR CONDITIONER CONDENSER	STANDARD (RADIATOR MOUNTED)	0	0
---	--------	------------------------------	--------------------------------	---	---

GAUGES & INSTRUMENTATION

S	0570002	INSTRUMENTS SALES PKG	STANDARD GAUGES (VOLTAGE AND OIL PRESSURE INCLUDED IN VEHICLE DISPLAY)	0	0
S	1430001	TRUCK ELECTRICAL CONTROL MODULE	VEHICLE CONTROL UNIT	0	0
S	1362000	TACHOMETER/RPM TACHOGRAPH	ELECTRONIC TACHOMETER	0	0
S	1372000	GAUGE-HOURMETER	HOURMETER INCLUDED IN ON BOARD DISPLAY	0	0
S	225009	AIR INTAKE RESTRICTION INDICATOR	GRADUATED, AIR CLEANER MOUNTED	0	0
O	3190001	PTO CONTROLS	PTO ELECTRIC CONTROL SWITCH	1	0
O	4390003	GAUGE-FUEL LEVEL	HOLE IN GAUGE PANEL FOR 2" NG FUEL GAUGE	0	0

LIGHTING

S	8360003	LAMPS-HEAD	LED HEADLAMPS	0	0
O	8410003	LAMPS-TURN SIGNAL - FRONT	LED TURN SIGNALS, FRONT END LOADER PACKAGE	1	0
S	8440003	SWITCH-TURN SIGNAL & FLASHER	SELF-CANCELING TURN SIGNALS	0	0
S	8510002	LAMPS-MARKER	AMBER LED ROOF MARKERS	0	0
O	8520001	LAMPS-PARKING	CORNER MARKER LAMP WIRED TO BATTERY SHUT OFF	1	0
O	859002	LAMPS-RUNNING	DAYTIME - W/O PARK BRAKE DE-ACTIVATION	0	0
S	8700001	CIRCUIT PROTECTION DEVICE	AUTO CIRCUIT BREAKERS	0	0

RADIO/MISC

S	509001	KEY & LOCK SETS- IGN/DOORS	DOOR & IGNITION SAME - UNIQUE PER TRUCK	0	0
O	5900006	RADIO	AM/FM RADIO, ROOF MOUNTED	13	-4
O	5910002	ANTENNA/POWER SUPPLY	ANTENNA - ROOF MOUNTED	0	0
O	596005	RADIO SPEAKERS	2 DUAL CONE SPEAKERS	0	0
S	8730001	WIRING-CAB	RADIO SHUT-OFF IN REVERSE	0	0
O	962003	FIRE EXTINGUISHER	DRY TYPE ABC 5LB. CAP MTD. IN CAB	2	0

FRONT TIRES / WHEELS

O	9050017	WHEELS-DISC FRONT	22.5x12.25" STEEL HP, 4.75" INSET, 5HH	32	0
---	---------	-------------------	-------------------------------------------	----	---

S	905T98	SPARE WHEELS FRONT (IF ORDERED AFTER 5-26-2017 DISTRIBUTOR RESPONSIBLE FOR SHIPPING BY LTL)	NO SPARE FRONT WHEELS	0	0
O	930821	TIRE SIZE & LOAD RANGE - FRONT	425/65R22.5L	0	0
O	9310001	TIRE MANUFACTURER & TREAD - FRONT	MICHELIN XZY-3	118	0
S	931T98	SPARE FRONT TIRE (IF ORDERED AFTER 5-26-2017 DISTRIBUTOR RESPONSIBLE FOR SHIPPING BY LTL)	NO SPARE FRONT TIRES	0	0

REAR TIRES / WHEELS

S	9140014	WHEELS-DISC REAR	22.5X8.25" STEEL HP, 5HH	0	0
S	914T98	SPARE WHEELS REAR (IF ORDERED AFTER 5-26-2017 DISTRIBUTOR RESPONSIBLE FOR SHIPPING BY LTL)	NO SPARE REAR WHEELS	0	0
O	933063	TIRE SIZE & LOAD RANGE - REAR	12R22.5H	0	0
S	9340043	TIRE MANUFACTURER & TREAD - REAR	GOODYEAR G182 RSD	0	144
S	934T98	SPARE REAR TIRE (IF ORDERED AFTER 5-26-2017 DISTRIBUTOR RESPONSIBLE FOR SHIPPING BY LTL)	NO SPARE REAR TIRES	0	0

PAINT

S	950001	CAB PAINT SCHEME	SINGLE COLOR PAINT	0	0
O	9550002	CAB PAINT TYPE	CAB FIRST COLOR OTHER THAN STD, NON METALLIC	0	0
A	9801000	CAB COLOR-FIRST	Unapproved -- DPSS-44426 -- BLUE	0	0
S	9861U1	CHASSIS COLOR	BLACK P3036	0	0
S	987949	BUMPER COLOR	SAME AS CHASSIS, UNPAINTED ALUM OR CHROME	0	0
O	9880002	DISC WHEEL OR RIM COLOR	POWDER COAT BLACK (DOES NOT MATCH FRAME BLACK)	0	0

ADDITIONAL OPTIONS

S	899002	CHASSIS WARRANTY	STANDARD WARRANTY	0	0
I	899A203	TRANSMISSION WARRANTY	ALLISON 5YR. EXT WARRANTY	0	0

O	899B182	ENGINE WARRANTY	2018 ISX12N GE1 5 YRS/150K MILES EXTENDED WARRANTY PPI MATRIX 424195	0	0
S	978015	FLOOR PLAN	15 DAYS FLOORING	0	0

OTHERS

S	R010999	READY TRUCK SPEC	NO READY SPEC	0	0
S	133003	ACCELERATOR PEDAL & LINK	WILLIAMS ACCELERATOR	0	0
S	9722000	CERTIFICATION- EMISSIONS	COMPLIES WITH 2017 U.S. EMISSIONS	0	0

SUB TOTALS

BASE WEIGHT	10,431	6,154
FACTORY OPTION WEIGHT	590	493
DISTRIBUTOR OPTION WEIGHT	0	0

TOTALS

TOTAL WEIGHT (LB)	11,021	6,647	17,668
-------------------	--------	-------	--------

10/26/2017

Dimensions

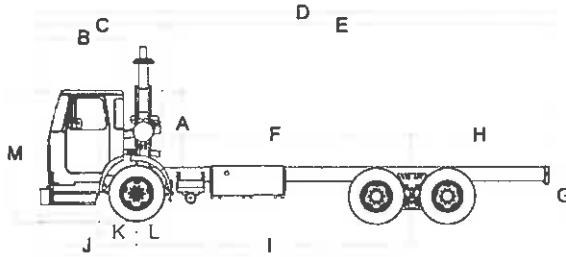

	Dimension(ft)	Description
A	59.00	CAB HEIGHT
B	62.00	BUMPER TO BACK OF CAB
C	95.00	EFFECTIVE BUMPER TO BACK OF CAB
D	379.00	OVERALL LENGTH
E	284.00	EFFECTIVE CAB TO END OF FRAME
F	180.00	EFFECTIVE CAB TO REAR AXLE
G	43.95	UNLADEN FRAME HEIGHT
H	104.00	OVERHANG
I	204.00	WHEELBASE
J	71.00	BUMPER TO FRONT AXLE
K	-24.00	DRIVER CENTER OF GRAVITY
L	24.00	EFFECTIVE FRONT AXLE TO BACK
M	102.95	OVERALL HEIGHT
N	0.00	FRONT FRAME EXTENSION

SPECIFICATION SUMMARY

Model	ACX64 Class 8
Engine	ISX12N, '18 330 HP @ 2100 / 1250 LB-FT, CUMMINS
Transmission	ALLISON 4500 SERIES,6-SPEED
Rear Axle	MERITOR RT46-160 46,000 LB
Rear Axle Ratio	5.38
Rear Tire	12R22.5H

10/26/2017

Turning Radius

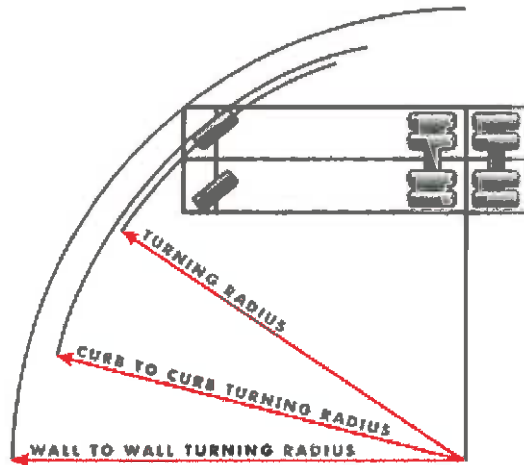

	Dimension(ft)	Description
A	34.36	TURNING RADIUS
B	71.49	CURB TO CURB TURNING DIAMETER
C	76.86	WALL TO WALL TURNING DIAMETER

SPECIFICATION SUMMARY

Model	
Engine	ISX12N, '18 330 HP @ 2100 / 1250 LB-FT, CUMMINS
Transmission	ALLISON 4500 SERIES,6-SPEED
Rear Axle	MERITOR RT46-160 46,000 LB
Rear Axle Ratio	5.38
Rear Tire	12R22.5H

10/26/2017

Shift Chart

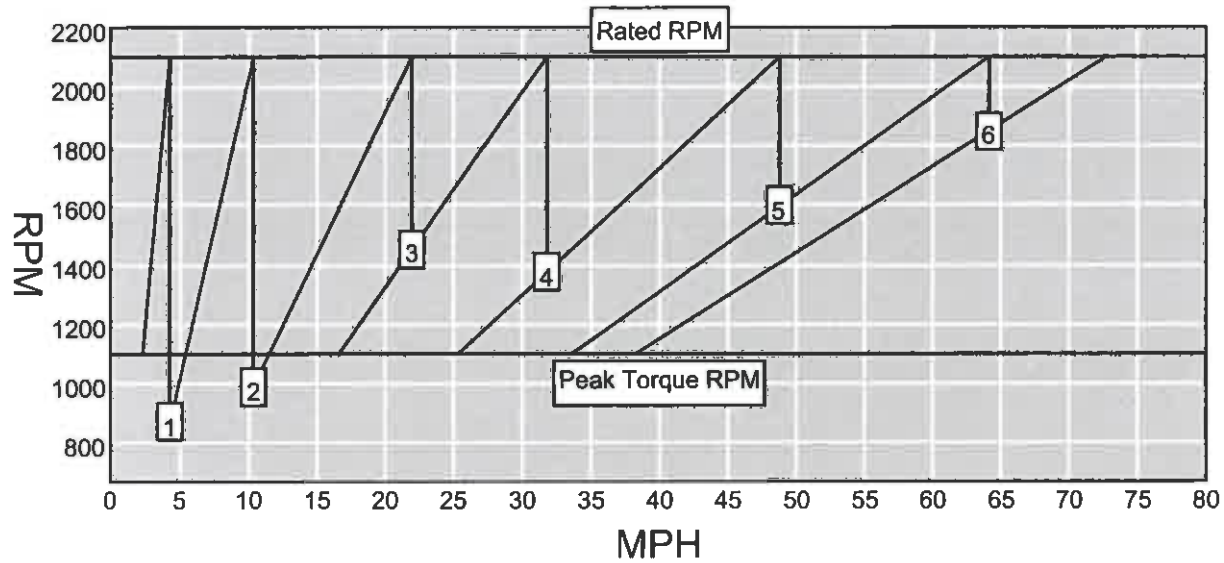

Gear	Trans. Ration	Rear Axle Ration	Overall Reduction	% Split	MPH	RPM After Shift
1C	11.37	5.38	61.2	0.0	4.3	0
1	4.70	5.38	25.3	141.9	10.4	868
2	2.21	5.38	11.9	112.7	22.0	987
3	1.53	5.38	8.2	44.4	31.8	1,453
4	1.00	5.38	5.4	53.0	48.7	1,372
5	0.76	5.38	4.1	31.6	64.1	1,596
6	0.67	5.38	3.6	13.4	72.7	1,851

SPECIFICATION SUMMARY

Model	ACX64 Class 8
Engine	ISX12N, '18 330 HP @ 2100 / 1250 LB-FT, CUMMINS
Rated Power	330 HP @ 2100 RPM
Peak Torque	1250 LB-FT @ 1100
Transmission	ALLISON 4500 SERIES,6-SPEED
Rear Axle	MERITOR RT46-160 46,000 LB
Rear Axle Ratio	5.38
Rear Tire	12R22.5H
Tire Revolution	0

10/26/2017

Operating Range

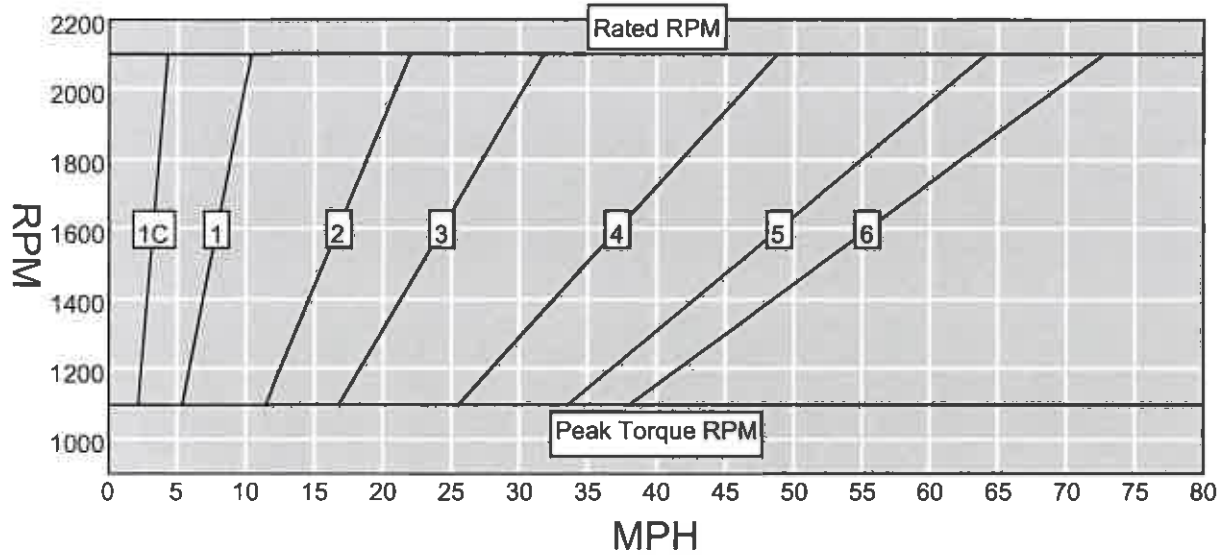

Gear	Trans. Ratio	Rear Axle Ratio	Minimum MPH	Maximum MPH
1C	11.37	5.38	2.2	4.3
1	4.70	5.38	5.4	10.4
2	2.21	5.38	11.5	22.0
3	1.53	5.38	16.7	31.8
4	1.00	5.38	25.5	48.7
5	0.76	5.38	33.6	64.1
6	0.67	5.38	38.1	72.7

SPECIFICATION SUMMARY

Model	ACX64 Class 8
Engine	ISX12N, '18 330 HP @ 2100 / 1250 LB-FT, CUMMINS
Rated Power	330 HP @ 2100 RPM
Peak Torque	1250 LB-FT @ 1100
Transmission	ALLISON 4500 SERIES,6-SPEED
Rear Axle	MERITOR RT46-160 46,000 LB
Rear Axle Ratio	5.38
Rear Tire	12R22.5H
Tire Revolution	0

10/26/2017

Gradeability

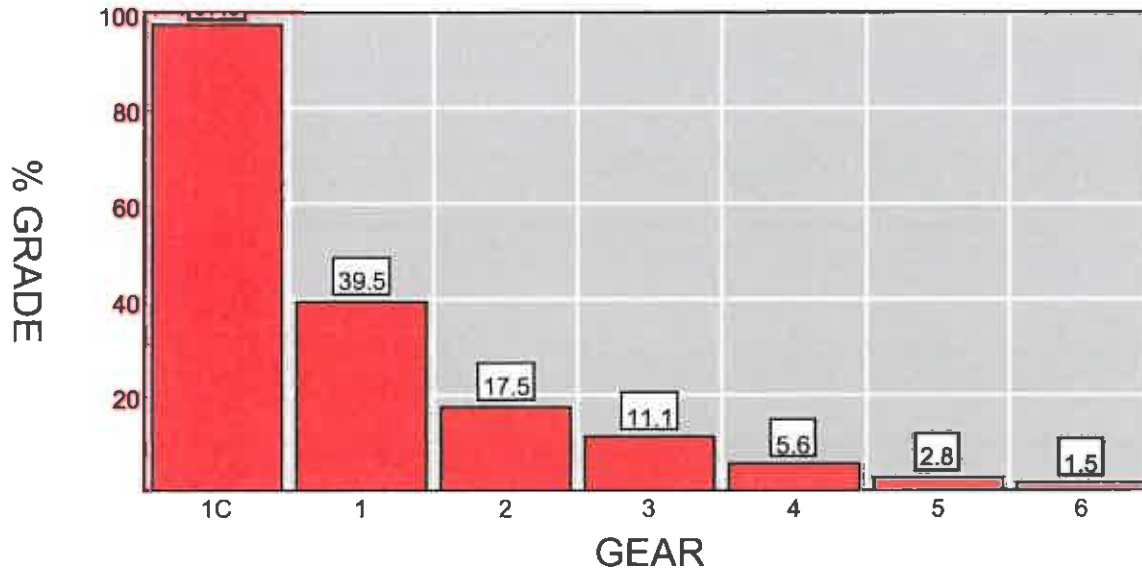

Gear	Trans. Ratio	Rear Axle Ratio	Overall Reduction	Peak Torque	Wheel HP	MPH	Maximum Grade%
1C	11.37	5.38	61.2	1,250.0	263.7	2.2	97.3
1	4.70	5.38	25.3	1,250.0	263.7	5.4	39.5
2	2.21	5.38	11.9	1,250.0	263.7	11.5	17.5
3	1.53	5.38	8.2	1,250.0	263.7	16.7	11.1
4	1.00	5.38	5.4	1,250.0	263.7	25.5	5.6
5	0.76	5.38	4.1	1,250.0	263.7	33.6	2.8
6	0.67	5.38	3.6	1,250.0	263.7	38.1	1.5

SPECIFICATION SUMMARY

Model	ACX64 Class 8
Engine	ISX12N, '18 330 HP @ 2100 / 1250 LB-FT, CUMMINS
Peak Torque	1250 LB-FT @ 1100
Transmission	ALLISON 4500 SERIES,6-SPEED
Rear Axle	MERITOR RT46-160 46,000 LB
Rear Axle Ratio	5.38
Rear Tire	12R22.5H
Tire Revolution	0
GVW/GCV	0
Surface	Concrete

10/26/2017

Startability

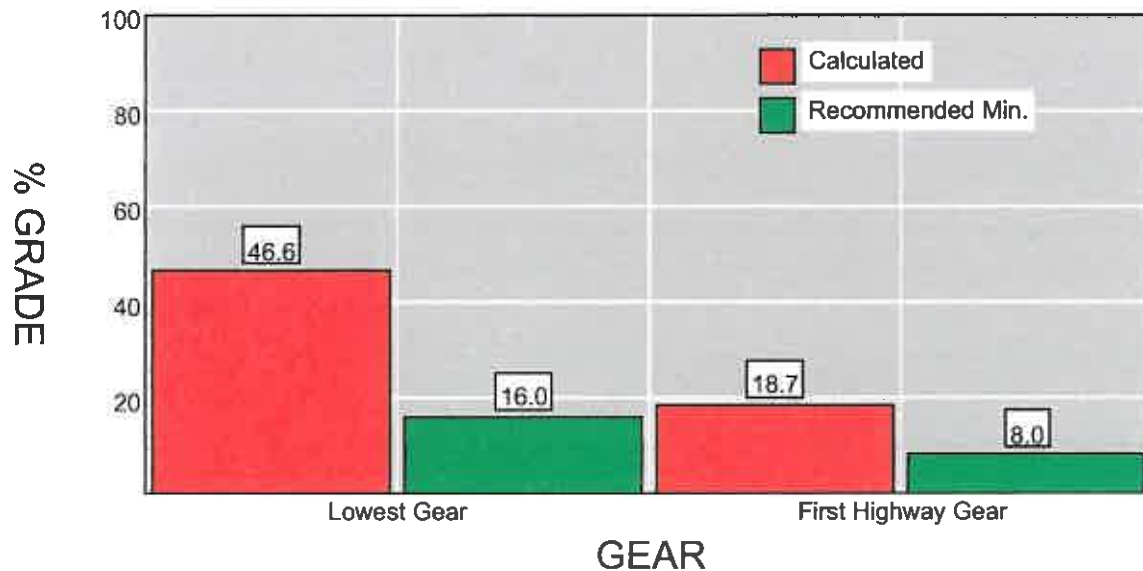

Gear	Application	Recommended Minimum Grade %	Calculated Grade %
Lowest Gear	City	12.0	n/a
	On Highway	16.0	46.6
	On-Off Highway	18.0	n/a
	Off Highway	20.0	n/a
			0.0
First Highway Gear	All Applications	8.0	18.7

"SPECIFICATION SUMMARY"

Model	ACX64 Class 8
Engine	ISX12N, '18 330 HP @ 2100 / 1250 LB-FT, CUMMINS
Clutch Torque	700 LB-FT 700 RPM
Transmission	ALLISON 4500 SERIES,6-SPEED
Rear Axle	MERITOR RT46-160 46,000 LB
Rear Axle Ratio	5.38
Rear Tire	12R22.5H
Tire Radius	0
GVW/GCV	0
Surface	Concrete
Terrain	On Highway

10/26/2017

Top Speed

Speed At Maximum RPM



RPM At 60MPH



	MPH	RPM
Top Speed	72.7	2,100
Cruise Speed	60.0	1,733
Minimum Of Engine Range	24.2	700
Maximum Of Engine Range	72.7	2,100
Minimum Of Economy Range	38.1	1,100
Maximum Of Economy Range	51.9	1,500

SPECIFICATION SUMMARY

Model	ACX64 Class 8
Engine	ISX12N, '18 330 HP @ 2100 / 1250 LB-FT, CUMMINS
Transmission	ALLISON 4500 SERIES,6-SPEED
Rear Axle	MERITOR RT46-160 46,000 LB
Rear Axle Ratio	5.38
Rear Tire	12R22.5H
Tire Revolution	0



#143-2017 Cab & Chassis Truck with Front Loading Refuse Collection Body



Refuse Hauling Solutions, LLC

**2017 HERCULES Commercial Front Loader
Product and Order Code Information**



HERCULES Product Overview

For over 60 years E-Z Pack has been the industry leader in mobile refuse collection vehicle designs and specializes refuse body manufacturing. E-Z Packs reputation is noted for its high quality, durability, easy to use operator controls, giving you the lowest cost of ownership in the industry.

The following for your review is detailed information on the HERCULES Commercial Front Loader design and manufacturing process. Plus information on optional equipment to customize your equipment to your needs.





HERCULES Features

The legendary E-Z Pack HERCULES offers unique design features that are unmatched in the industry. Compare for yourself and you will see why the HERCULES is the best buy in the business.

Standard Features include:

- ✓ Commercial Hopper Opening 101” Long
- ✓ Heavy Duty Interlaced Hopper Floor Support
- ✓ HD Packer Panel with (4) AR500 Wear Shoes and Tracks
- ✓ Radius Body Sides, Roof and Floor
- ✓ Large Side Hopper Access Door
- ✓ Automatic Locking Tailgate with Safety Pins
- ✓ Heavy Duty Packer Cylinder Bulk Head
- ✓ Plug and Play Sectional Main Body Wire Harness
- ✓ Premium Powder Coat Body Paint
- ✓ Factory Applied Under-Body Coating



Feature includes the following:
(6) Remote packer panel lube lines routed to the front of the packer panel support tube for easy servicing of the packer blade cylinder pins.

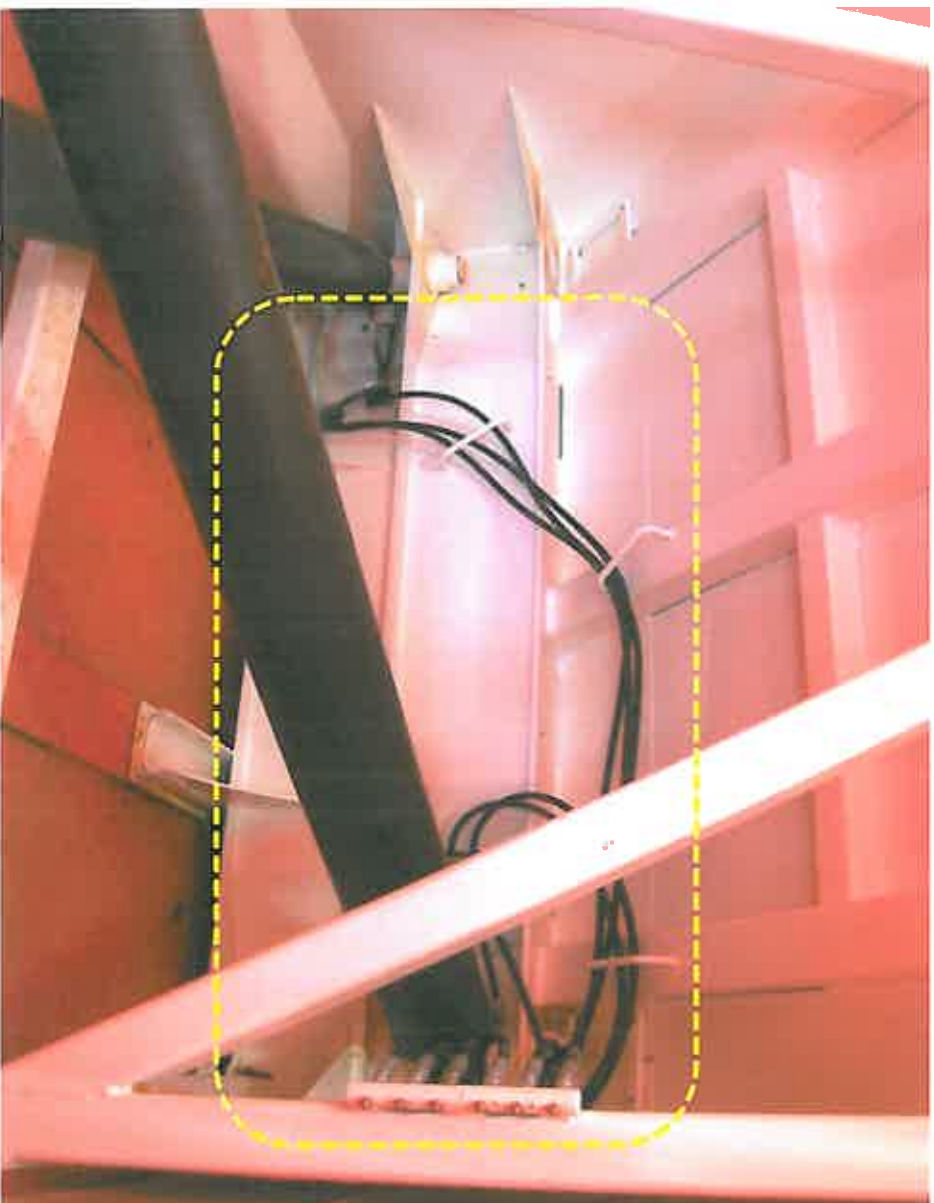

Model Year	2017	Order Code	Standard
Description	Packer Panel Remote Lube Lines		



The new 2017 E-Z Pack HERCULES front loader includes integrated operator controls for Mack, Peterbilt and Autocar chassis.



Model Year	2017	Order Code	Standard
Description	Integrated Operator Controls		



The new 2017 E-Z Pack HERCULES front loader body side walls are built with 7 gauge 100,000 PSI high strength steel for a long service life.



Model Year	2017	Order Code	Standard
Description	7 Gauge Body Side Walls		



The 2017 E-Z Pack HERCULES front loader hopper sump overlay is standard on all models. Optional hopper sumps available upon request.



Model Year	2017	Order Code	Standard
Description	Hopper Body Sump Overlay		

HERCULES Steel Specifications

The Hercules is rugged built with high quality grade steel that is engineered for the application.

Additional wear liners are available upon request and application specification.

Description	Gauge	Grade
Hopper Floor	1/4"	AR 155,000 PSI Single Plate
Hopper Long Sill	7 Ga.	100,000 PSI Smart Steel Form Channel
Hopper Long Sill Crossmember	3/16"	4" x 3" Steel Tube
Hopper Crossmember Support	7 Ga.	8" Long Sleeve
Hopper Transition Crossmember	1/4"	6" x 4" Steel Tube
Hopper Lower Side Walls	3/16"	100,000 PSI Smart Steel
Hopper Lower Side Wall Liner	10 Ga.	100,000 PSI Smart Steel 22" High
Hopper Upper Hopper Side Walls	10 Ga.	100,000 PSI Smart Steel
Cab Guard	12 Ga.	50,000 PSI Smart Steel

Body Roof	10 Ga.	100,000 PSI Smart Steel - Radius
Body Side Walls	7 Ga.	100,000 PSI Smart Steel - Radius
Body Floor	7 Ga.	100,000 PSI Smart Steel - Radius

Roof Superstructure	7 Ga.	100,000 PSI Smart Steel 2 1/4" x 8 3/8" Formed Channel
Roof Superstructure	3/16"	3" x 2" Steel Tube
Body Floor Structure	7 Ga.	100,000 PSI Smart Steel "V" Channel
Body Floor Rear Bolster	1/4"	100,000 PSI Smart Steel Formed Channel

Lift Arm Support Bar	3/4"	3" 80,000 PSI Smart Steel - Bar
Lift Arm Side Plates	1/4"	100,000 PSI Smart Steel - Plate
Lift Arm Cylinder Anchor Plates	1/2"	50,000 PSI Smart Steel - Plate
Fork Tangs 60"	1"	T-1 Steel Plate
Fork Torque Tube	3/4"	Seamless Steel Tubing 3 1/2" O.D.

Packer Panel Super Structure	1/4"	100,000 PSI 3" x 3" Steel Tube
Packer Panel Lower Face Plate	1/4"	100,000 PSI Smart Steel - Plate
Packer Panel Slope Face Plate	7 Ga.	100,000 PSI Smart Steel - Plate
Packer Panel Upper Face Plate	10 Ga.	100,000 PSI Smart Steel - Plate
Packer Panel Guide Channels	3/8"	AR500 180,000 PSI 3" Wide Wear Plate
Packer Panel Center Wear Tracks	3/8"	AR500 180,000 PSI 6" Wide Wear Plate

Tailgate Walls	10 Ga.	100,000 PSI Smart Steel
Tailgate Braces	7 Ga.	100,000 PSI Smart Steel
Tailgate Hinges	1/2"	100,000 PSI Smart Steel - Plate



Premium Design and Hydraulic Components

From line sizes to the large hydraulic filters, the EZ Pack Hercules sets the industry standard by offering a premium hydraulic system.

HYDRAULIC PUMP - At the heart of the Hercules hydraulic system is the Muncie MLS hydraulic pump. The Muncie MLS hydraulic pump is a flow regulated hydraulic system that offers a “No Kick Out” feature when dumping containers and allows the operator to “Pack on the Run” with no pump damage or over heating.

Easy to Service Filter System - The Hercules offers a system the largest return line filter with “In-Cab Service Indicators” for extended hydraulic service life.

HIGH QUALITY HYDRAULIC CYLINDERS - E-Z Pack is equipped with premium hydraulic cylinders just for the waste industry, giving you years of trouble free service.

RUSTPROOF HYDRAULIC LINES - The Hercules hydraulic system offers maximum line sizes through out the system allowing less restriction and faster fluid cooling. Plus all steel lines are made from “Rust Proof” steel and are held in place with high quality clamps for a long service life.



The E-Z Pack HERCULES front loader packer cylinders designed specifically to withstand the severe environment of waste removal application.

The HERCULES front loader packer cylinders offers the following features:

- ✓ Stainless Steel – Scraper Wiper Rings
- ✓ Nitriding surface-hardening treatment
- ✓ High-Duty Cycle Design
- ✓ Self Aligning Cylinder Bearings
- ✓ Exchange/Rebuild Programs Available





E-Z Pack knows that their products lives a hard life and that is one of the reasons why E-Z Pack powder coats their products. Powder coat paint is **5 times** more durable than the traditional wet paint process, giving you more value.

As a standard benefit from E-Z Pack, a **protective industrial grade undercoating** is applied to the body for a long service life in all types of extreme weather conditions.

Another advantage, no electrical or hydraulic lines are not painted for easy trouble shooting and cleaner appearance.

E-Z Pack's powder coat paint is environmentally friendly. Keeping it safe!



E-Z Pack Powder Coat includes the following:

- Stage 1 Body cleaned, deburred, weld spatter and slag removed
- Stage 2 Multi-stage chemical treatment and high pressure wash.
- Stage 3 Apply Powder coat primer and finish coat
- Stage 4 Bake Booth - 325 Degrees until fully cured.
- Stage 5 Apply Industrial Grade Undercoating to Body
- Stage 6 Quality Control Inspection

Specification and Performance:

- 1) Dry film thickness is to be minimum 4 to 6 mills coverage.
- 2) Paint must pass minimum 1250 hours salt spray test for corrosion resistance.
- 3) Paint must pass UV test of 2000 hours for minimum loss of gloss and color shift.
- 4) Hydraulic cylinders and valves to be painted black semi-gloss.
- 5) Hose ends and hydraulic fittings to be anodized and remain unpainted.
- 6) Hydraulic tubing to be zinc dichromate plated and unpainted. Electrical harnesses, connections, switches, pneumatic tubing and fittings to be weatherproof and remain unpainted.





Refuse Hauling Solutions, LLC

HERCULES COMMERCIAL FRONT LOADER

Model FLOO80J40SE

- FL Front Loader
- OO Commercial Grade Body
- 80 8,000 Lift Capacity
- J Model Lift Arm
- 40 40 Cubic Yard Capacity
- S Sliding Top Door
- E Full Ejection Style



Standard Equipment includes the following:

- ✓ Commercial Grade Superstructure Assembly
- ✓ Bolt-on Lift Arms – 10,000 Lbs Construction
- ✓ Heavy Duty Tailgate with Auto Latch and Safety Prop
- ✓ SMART STEEL Radiuses Body Floor, Side and Roof
- ✓ 100 Gallon Body Sump for Liquid Retention
- ✓ Bolt on Cab Shield
- ✓ Sliding Hopper Cover
- ✓ Large Body Access Door with Safety Grab Handles
- ✓ Operator In Cab Air Control – Forks / Arm
- ✓ Auto Pack – Packer Controls
- ✓ Commercial Grade Hydraulic Package
- ✓ Premium Packer Cylinders
- ✓ E-Z Pack Operator Controls
- ✓ Powder Coating Paint White with Body Undercoating
- ✓ DOT Approved Reflective Tape
- ✓ MVSS108 Compliant Lights with LED Light
- ✓ High Mount Tailgate Lights with Center Brake Light
- ✓ Factory Made Wiring Harness
- ✓ ANSI Approved Top Body Tie Off Containment
- ✓ ANSI Approved Top Body Access Ladder
- ✓ Full Factory Mount
- ✓ Hopper Sump Overlay (New for 2017)
- ✓ 7 Ga Body Side Walls (New for 2017)
- ✓ Integrated Operator Controls (New for 2017)
- ✓ Packer Panel Remote Lube Lines (New for 2017)
- ✓ Top Body Access Ladder (New for 2017)

Model Year	2017	Order Code	CFL-40
------------	------	------------	--------

Description	Hercules 40 Cubic Yard Front Loader		
-------------	-------------------------------------	--	--

E-Z Pack Refuse Hauling Solutions, LLC, reserves the right under its Product Improvement Program to modify construction and/or design and furnish equipment without reference to illustrations and specifications shown herein. All specifications are subject to change without notice.



Option includes the following:
 Front body sump assembly to have front hopper sump door on both sides of body.

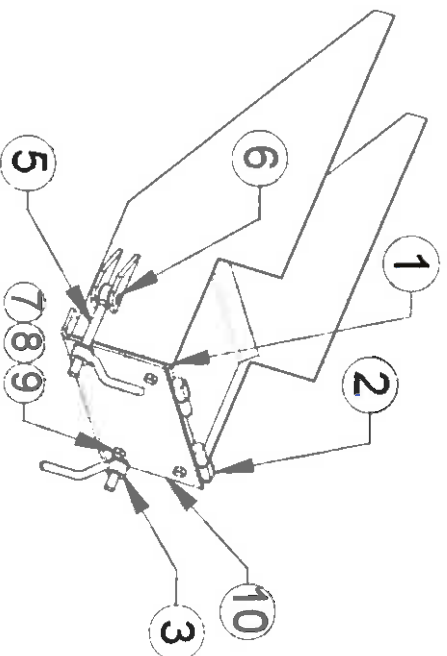
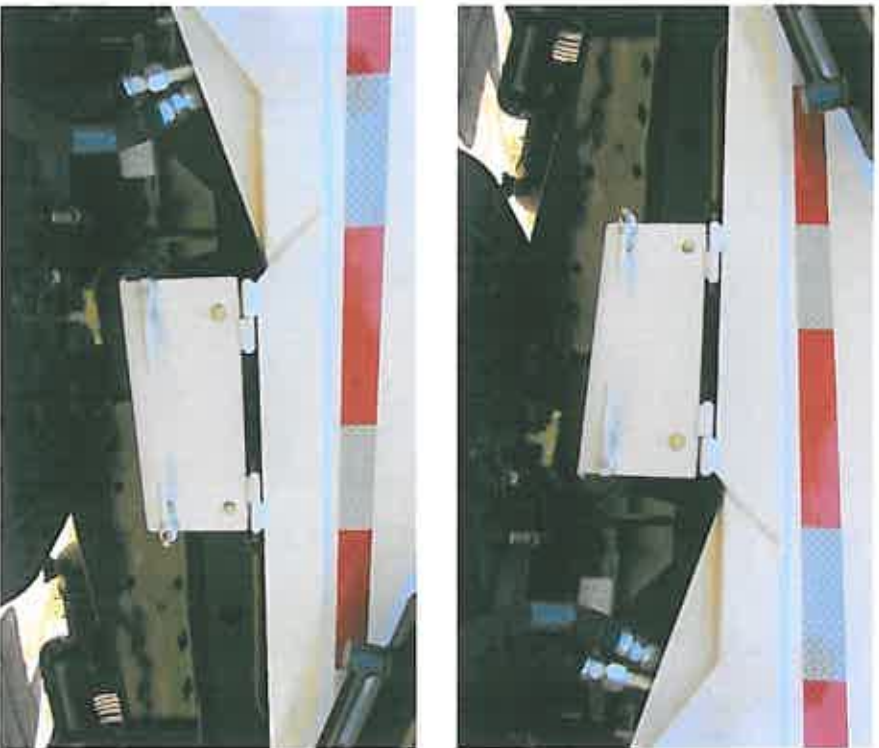

Model Year	2017	Order Code	FB3
Description	Dual Hopper Sump Doors		

E-Z Pack Refuse Hauling Solutions, LLC reserves the right under its Product Improvement Program to modify construction and/or design and furnish equipment without reference to illustrations and specifications shown herein. All specifications are subject to change without notice.



Option includes the following:
(4) 4" Heavy Duty Weld-in Sharks Teeth installed on the upper section of the packer panel.

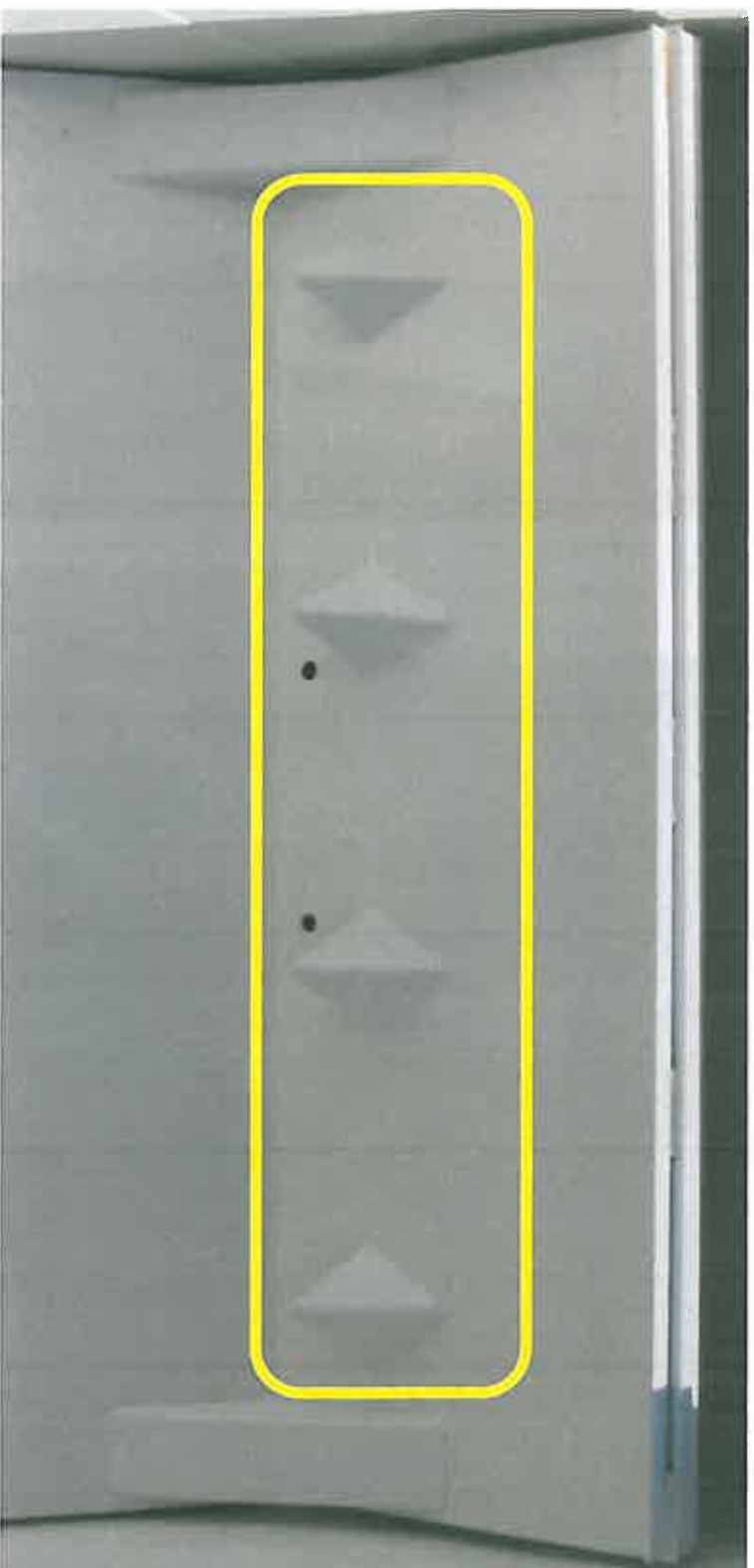

Model Year	2017	Order Code	FB6
Description	(4) 4" Sharks Teeth - Packer Blade		

EZ Pack Refuse Hauling Solutions, LLC, reserves the right under its Product Improvement Program to modify construction and/or design and furnish equipment without reference to illustrations and specifications shown herein. All specifications are subject to change without notice.



Option includes the following:
Heavy Duty expanded metal to cover for front bulk head



Model Year	2017	Order Code	FB11
Description	Front Body Screen Enclosure -Weld		

E-Z-Pack Refuse Hauling Solutions, LLC, reserves the right under its Product Improvement Program to modify construction and/or design and furnish equipment without reference to illustrations and specifications shown herein. All specifications are subject to change without notice.



Description: This new cab shield is radius so that any debris that falls out of the container when dumping will roll-off so that the operator will not need to climb on top the truck to remove the debris.

This option includes the following:

- New bolt-on Radius Cab Shield
- Pneumatic Extension
- Fork/Arm Interlock
- Side Exhaust Ports
- Raised Side Walls for Side Exhaust
- Available on:
 - Autocar ACX
 - Mack MRU
 - Peterbilt 320

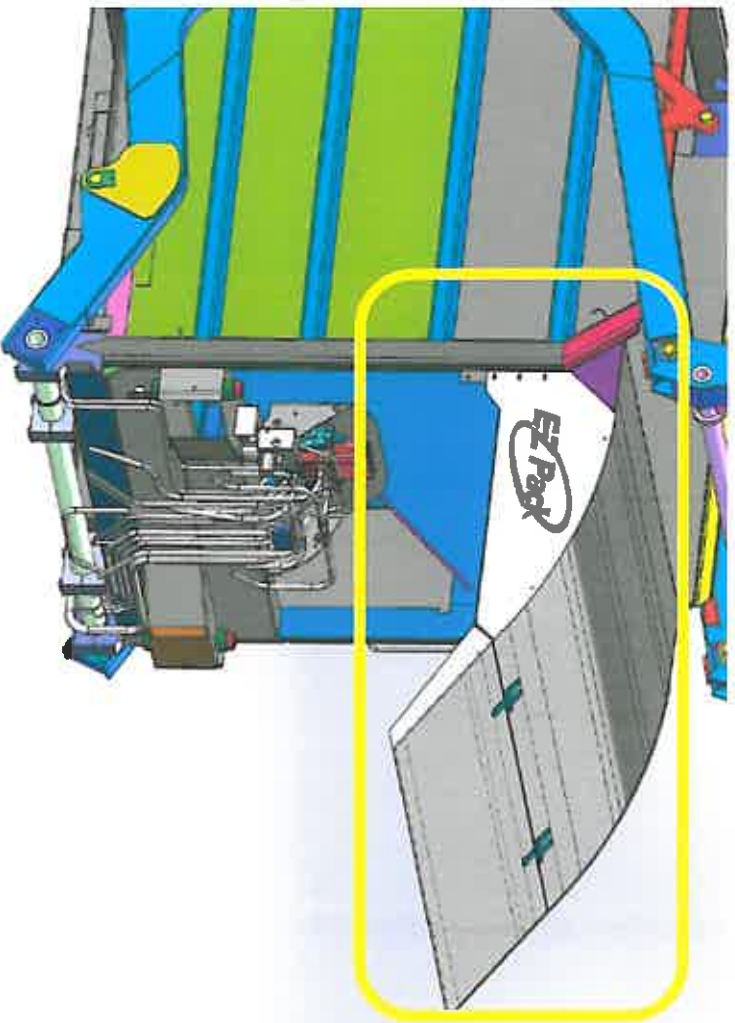

Model Year	2017	Order Code	FB14
Description	Radius Canopy with Air Flip Ext.		

E-Z Pack Refuse Hauling Solutions, LLC, reserves the right under its Product Improvement Program to modify construction and/or design and furnish equipment without reference to illustrations and specifications shown herein. All specifications are subject to change without notice.



Refuse Hauling Solutions, LLC

CleanShield is a multi-layered sandwich of films and adhesives designed to be easily applied, long lasting and most of all impervious to even the most corrosive mixture of environmental and waste related pollutants.

CleanShield can handle just about any pollutant you can throw at or on it!

Custom colors and logos available.



Model Year	2017	Order Code	FB43
Description	Cab Canopy Liner		

EZ Pack Refuse Hauling Solutions, LLC, reserves the right under its Product Improvement Program to modify construction and/or design and furnish equipment without reference to illustrations and specifications shown herein. All specifications are subject to change without notice.

Option includes the following:

- Factory Installed
- (1) 24" H x 72" W Caution Sign - Reflective



Model Year	2017	Order Code	FB26
Description	CAUTION Sign - Reflective		

E-Z Pack Refuse Hauling Solutions, LLC reserves the right under its Product Improvement Program to modify construction and/or design and furnish equipment without reference to illustrations and specifications shown herein. All specifications are subject to change without notice.



- Option includes the following:**
- 4” Rubber housing flood light mounted on the main control valve mounting bracket pointed into the body hopper.
 - Switched from in cab located on the packer control box

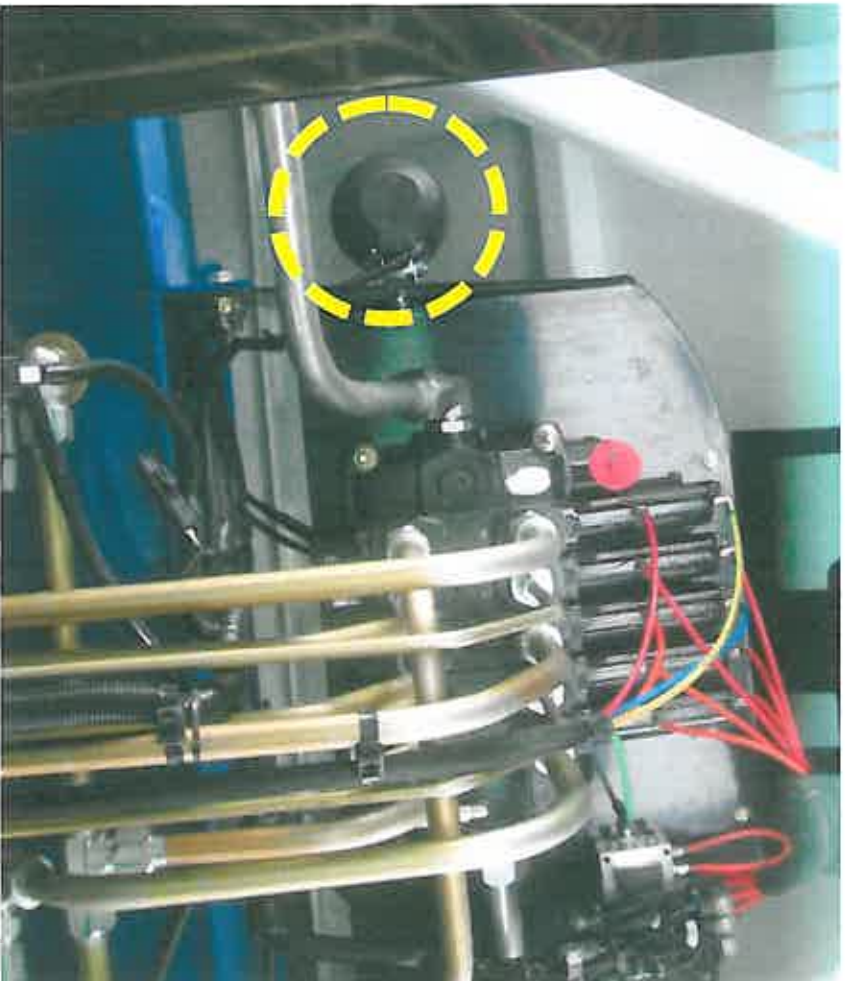

Model Year	2017	Order Code	FE1
Description	Hopper Flood Light		

E-Z Pack Refuse Hauling Solutions, LLC reserves the right under its Product Improvement Program to modify construction and/or design and furnish equipment without reference to illustrations and specifications shown herein. All specifications are subject to change without notice.



Option includes the following:

- (1) Container Flood Light
- Mounted on Chassis Mirror
- Switch In Cab
- LED Grade



Model Year	2017	Order Code	FE3
Description	Container Work Light - LED		

E-Z Pack Refuse Hauling Solutions, LLC, reserves the right under its Product Improvement Program to modify construction and/or design and furnish equipment without reference to illustrations and specifications shown herein. All specifications are subject to change without notice.



- Option includes the following:**
- 10,000 Lbs Lift Arm Cylinders



Model Year	2017	Order Code	FL1
Description	10,000 Lbs Lift Arm Cylinders		

E-Z Pack, Refuse Hauling Solutions, LLC reserves the right under its Product Improvement Program to modify construction and/or design and furnish equipment without reference to illustrations and specifications shown herein. All specifications are subject to change without notice.



- Option includes the following:**
- (4) Heavy Duty Stop Pads
 - (2) on Fork Tube
 - (2) on Arm Stops



Model Year	2017	Order Code	FL1
Description	10,000 Lbs Lift Arm Cylinders		

E-Z Pack Refuse Hauling Solutions, LLC, reserves the right under its Product Improvement Program to modify construction and/or design and furnish equipment without reference to illustrations and specifications shown herein. All specifications are subject to change without notice.



- Option includes the following:**
- 92.5 DGE (3) Tank CNG Fuel System
 - Integrated in the upper half of the tailgate



Model Year	2017	Order Code	FG5
Description	92.5 DGE CNG Fuel System		

E-Z Pack Refuse Hauling Solutions, LLC, reserves the right under its Product Improvement Program to modify construction and/or design and furnish equipment without reference to illustrations and specifications shown herein. All specifications are subject to change without notice.



- Option includes the following:**
- Auxiliary CNG fueling Port
 - Front Bumper Street Side



Model Year	2017	Order Code	FG7
Description	Additional CNG Fill Port		

EZ Pack Refuse Hauling Solutions, LLC, reserves the right under its Product Improvement Program to modify construction and/or design and furnish equipment without reference to illustrations and specifications shown herein. All specifications are subject to change without notice.



Paint Specifications

Component	Paint Color	Type
Body	Dupont Metallic Grey #444400U	Powder Coat
Ejector Panel	Standard White	Powder Coat
Tailgate	Dupont Metallic Grey #444400U	Powder Coat
Lift Arms	Dupont Metallic Grey #444400U	Powder Coat
Body Access Ladder	Black	Powder Coat
Tailgate Lift Cylinders	Standard Black	Wet Paint
Packer Cylinders	Standard Black	Wet Paint
Ejector Cylinder	Standard Black	Wet Paint
Underbody Ladder	Safety Yellow	Powder Coat

Model Year	2017	Order Code	RH1
Description	Non-Standard Body Paint		

- TV-905A VLI Series Night Vision Camera System with 9.0" Quad View Touch Screen LCD Monitor
- PC-1110 VLI Series™ Night Vision Camera KIT ... (Includes: Camera and 10m AV Cable)
- PC-1110 VLI Series™ Night Vision Camera KIT ... (Includes: Camera and 10m AV Cable)
- PC-1110 VLI Series™ Night Vision Camera KIT ... (Includes: Camera and 10m AV Cable)

Camera Locations:

- #1 Center Tailgate – Primary Backup
- #2 Hopper Container View – Midbody Post
- #3 Curb Side Tailgate – Side View
- #4 Street Side Tailgate – Side View



Model Year	2017	Order Code	Special
Description	Pro Vision Quad Camera System		

10.11 Tool box: A weatherproof stainless steel tool box (Bawer TU826500) shall be installed under the right side of truck, mounted on truck frame.



Model Year	2017	Order Code	Special
Description	24x24x36 Stainless Steel Tool Box		

EZ Pack Refuse Hauling Solutions, LLC, reserves the right under its Product Improvement Program to modify construction and/or design and furnish equipment without reference to illustrations and specifications shown herein. All specifications are subject to change without notice.

350,000 SQ. FT of sparks, steel, and hard work



They say a house is only as good as it's foundation. If the foundation of a manufacturing company is it's factory, then we have a great base to build on. With over 350,000 square feet under roof, our plant provides us the opportunity to stabilize, modernize and improve the EZ-Pack Product line.

Making investments in new technologies, new fixtures, and new methods of production to ensure that we stay competitive and deliver a high quality product that lives up to the EZ-Pack name.

We invite you to come see what we're about. Factory tours are always available,

Come meet the hard working men and women that actually build your next body. We'll even let you drive your completed unit off the line, just let us know and we'll be happy to arrange it.

