



LEXINGTON

Lexington-Fayette Urban County Government

Lexington, Kentucky
Horse Capital of the World

Division of Central Purchasing

Date of Issue: March 9, 2021

INVITATION TO BID #23-2021 Snow Plows

Bid Opening Date: March 23, 2021 **Bid Opening Time:** 2:00 PM
Address: 200 East Main Street, 3rd Floor, Room 338, Lexington, Kentucky 40507
Type of Bid: Price Contract

Pre Bid Meeting: N/A **Pre Bid Time:** N/A
Address: N/A

Sealed bids will be received via Ion Wave, until **2:00 PM**, prevailing local time on **3/23/2021**. Bids must be received by the above-mentioned date and time. Bids should be submitted via:

Ion Wave
<https://lexingtonky.ionwave.net>

The Lexington-Fayette Urban County Government assumes no responsibility for bids that are not delivered as indicated above. All bids must be signed. Bids are to include all shipping, handling and associated fees to the point of delivery located at: Lexington, KY

<input checked="" type="checkbox"/> Bid Specifications Met Check One: <input type="checkbox"/> Exceptions to Bid Specifications. <i>Exceptions shall be itemized and attached to bid proposal submitted.</i>		Proposed Delivery: <u>75</u> days after acceptance of bid.
Procurement Card Usage —The Lexington-Fayette Urban County Government may be using Procurement Cards to purchase goods and services and also to make payments. Will you accept Procurement Cards? <input type="checkbox"/> Yes <input checked="" type="checkbox"/> No		

Submitted by: J. Edinger & Son, Inc.
Firm Name
1010 Story Ave.
Address
Louisville, KY 40206
City, State & Zip

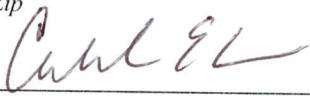
Bid must be signed:  President
(original signature) **Signature of Authorized Company Representative – Title**

Charles R. Edinger, III
Representative's Name (Typed or printed)
502-584-3524 502-584-7067
Area Code - Phone – Extension *Fax #*
charlesedinger.3@gmail.com
E-Mail Address

The Affidavit in this bid must be completed before your firm can be considered for award of this contract.

AFFIDAVIT

Comes the Affiant, Charles R. Edinger, III, and after being first duly sworn under penalty of perjury as follows:

1. His/her name is Charles R. Edinger, III and he/she is the individual submitting the bid or is the authorized representative of J. Edinger & Son, Inc. the entity submitting the bid (hereinafter referred to as "Bidder")
2. Bidder will pay all taxes and fees, which are owed to the Lexington-Fayette Urban County Government at the time the bid is submitted, prior to award of the contract and will maintain a "current" status in regard to those taxes and fees during the life of the contract.
3. Bidder will obtain a Lexington-Fayette Urban County Government business license, if applicable, prior to award of the contract.
4. Bidder has authorized the Division of Central Purchasing to verify the above-mentioned information with the Division of Revenue and to disclose to the Urban County Council that taxes and/or fees are delinquent or that a business license has not been obtained.
5. Bidder has not knowingly violated any provision of the campaign finance laws of the Commonwealth of Kentucky within the past five (5) years and the award of a contract to the Bidder will not violate any provision of the campaign finance laws of the Commonwealth.
6. Bidder has not knowingly violated any provision of Chapter 25 of the Lexington-Fayette Urban County Government Code of Ordinances, known as "Ethics Act."
7. Bidder acknowledges that "knowingly" for purposes of this Affidavit means, with respect to conduct or to circumstances described by a statute or ordinance defining an offense, that a person is aware or should have been aware that his conduct is of that nature or that the circumstance exists.

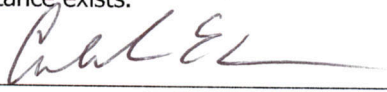
Further, Affiant sayeth naught. 

STATE OF Kentucky

COUNTY OF Jefferson

The foregoing instrument was subscribed, sworn to and acknowledged before me by Charles R. Edinger, III on this the 16th day of March, 2021.

My Commission expires: 4/26/2023

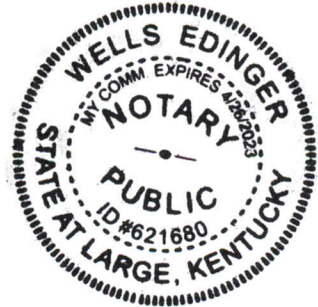

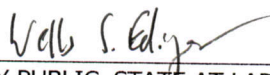
NOTARY PUBLIC, STATE AT LARGE

Please refer to Section II. Bid Conditions, Item "U" prior to completing this form.

I. GREEN PROCUREMENT

A. ENERGY

The Lexington-Fayette Urban County Government is committed to protecting our environment and being fiscally responsible to our citizens.

The Lexington-Fayette Urban County Government mandates the use of Energy Star compliant products if they are available in the marketplace (go to www.Energystar.gov). If these products are available, but not submitted in your pricing, your bid will be rejected as non-compliant.

ENERGY STAR is a government program that offers businesses and consumers energy-efficient solutions, making it easy to save money while protecting the environment for future generations.

Key Benefits

These products use 25 to 50% less energy
Reduced energy costs without compromising quality or performance
Reduced air pollution because fewer fossil fuels are burned
Significant return on investment
Extended product life and decreased maintenance

B. GREEN SEAL CERTIFIED PRODUCTS

The Lexington-Fayette Urban County Government is also committed to using other environmentally friendly products that do not negatively impact our environment. Green Seal is a non-profit organization devoted to environmental standard setting, product certification, and public education.

Go to www.Green Seal.org to find available certified products. These products will have a reduced impact on the environment and on human health. The products to be used must be pre-approved by the LFUCG prior to commencement of any work in any LFUCG facility. If a Green Seal product is not available, the LFUCG must provide a signed waiver to use an alternate product. Please provide information on the Green Seal products being used with your bid response.

C. GREEN COMMUNITY

The Lexington-Fayette Urban County Government (LFUCG) serves as a principal, along with the University of Kentucky and Fayette County Public Schools, in the Bluegrass Partnership for a Green Community. The Purchasing Team component of the Partnership collaborates on economy of scale purchasing that promotes and enhances environmental initiatives. Specifically, when applicable, each principal is interested in obtaining best value products and/or services which promote environment initiatives via solicitations and awards from the other principals.

If your company is the successful bidder on this Invitation For Bid, do you agree to extend the same product/service pricing to the other principals of the Bluegrass Partnership for a Green Community (i.e. University of Kentucky and Fayette County Schools) if requested?

Yes No

II. Bid Conditions

- A. No bid may be withdrawn for a period of sixty (60) days after the date and time set for opening.
- B. No bid may be altered after the date and time set for opening. In the case of obvious errors, the Division of Central Purchasing may permit the withdrawal of a bid. The decision as to whether a bid may be withdrawn shall be that of the Division of Central Purchasing.
- C. Acceptance of this proposal shall be enactment of an Ordinance by the Urban County Council.
- D. The bidder agrees that the Urban County Government reserves the right to reject any and all bids for either fiscal or technical reasons, and to award each part of the bid separately, all parts to one vendor or all parts to multiple vendors.
- E. Minor exceptions may not eliminate the bidder. The decision as to whether any exception is minor shall be entirely that of the head of the requisitioning Department or Division and the Director of the Division of Central Purchasing. The Urban County Government may waive technicalities and informalities where such waiver would best serve the interests of the Urban County Government.
- F. Manufacturer's catalogue numbers, trade names, etc., where shown herein are for descriptive purposes and are to guide the bidder in interpreting the standard of quality, design, and performance desired, and shall not be construed to exclude proposals based on furnishing other types of materials and/or services. However, any substitution or departure proposed by the bidder must be clearly noted and described; otherwise, it will be assumed that the bidder intends to supply items specifically mentioned in this Invitation for Bids.
- G. The Urban County Government may require demonstrations of the materials proposed herein prior to acceptance of this proposal.
- H. Bids must be submitted on this form and must be signed by the bidder or his authorized representative. Unsigned bids will not be considered.
- I. Bids must be submitted prior to the date and time indicated for opening. Bids submitted after this time will not be considered.
- J. Bids that are not submitted via Ion Wave will be rejected.
- K. Bidder is requested to show both unit prices and lot prices. In the event of error, the unit price shall prevail.
- L. A certified check or Bid Bond in the amount of XX percent of the bid price must be attached hereto. This check must be made payable to the Lexington-Fayette Urban County Government, and will be returned when the material and/or services specified herein have been delivered in accordance with specifications. In the event of failure to perform within the time period set forth in this bid, it is agreed the certified check may be cashed and the funds retained by the Lexington-Fayette Urban County Government as liquidated damages. Checks of unsuccessful bidders will be returned when the bid has been awarded.
- M. The delivery dates specified by bidder may be a factor in the determination of the successful bidder.
- N. Tabulations of bids received may be mailed to bidders. Bidders requesting tabulations must enclose a stamped, self-addressed envelope with the bid.
- O. The Lexington-Fayette Urban County Government is exempt from Kentucky Sales Tax and Federal Excise Tax on materials purchased from this bid invitation. Materials purchased by the bidder for construction projects are not tax exempt and are the sole responsibility of the bidder.
- P. All material furnished hereunder must be in full compliance with OSHA regulations.
- Q. If more than one bid is offered by one party, or by any person or persons representing a party, all such bids shall be rejected.
- R. Signature on the face of this bid by the Bidder or his authorized representative shall be construed as acceptance of and compliance with all terms and conditions contained herein.

- S. The Entity (regardless of whether construction contractor, non-construction contractor or supplier) agrees to provide equal opportunity in employment for all qualified persons, to prohibit discrimination in employment because of race, color, religion, sex (including pregnancy, sexual orientation or gender identity), national origin, disability, age, genetic information, political affiliation, or veteran status, and to promote equal employment through a positive, continuing program from itself and each of its sub-contracting agents. This program of equal employment opportunity shall apply to every aspect of its employment policies and practices.
- T. The Kentucky Equal Employment Opportunity Act of 1978 (KRS 45.560-45.640) requires that any county, city, town, school district, water district, hospital district, or other political subdivision of the state shall include in directly or indirectly publicly funded contracts for supplies, materials, services, or equipment hereinafter entered into the following provisions:

During the performance of this contract, the contractor agrees as follows:

- (1) *The contractor will not discriminate against any employee or applicant for employment because of race, color, religion, sex, age or national origin;*
- (2) *The contractor will state in all solicitations or advertisements for employees placed by or on behalf of the contractors that all qualified applicants will receive consideration for employment without regard to race, color, religion, sex, age or national origin;*
- (3) *The contractor will post notices in conspicuous places, available to employees and applicants for employment, setting forth the provisions of the non-discrimination clauses required by this section; and*
- (4) *The contractor will send a notice to each labor union or representative of workers with which he has a collective bargaining agreement or other contract or understanding advising the labor union or workers' representative of the contractor's commitments under the nondiscrimination clauses.*

The Act further provides:

KRS 45.610. Hiring minorities - Information required

- (1) *For the length of the contract, each contractor shall hire minorities from other sources within the drawing area, should the union with which he has collective bargaining agreements be unwilling to supply sufficient minorities to satisfy the agreed upon goals and timetable.*
- (2) *Each contractor shall, for the length of the contract, furnish such information as required by KRS 45.560 to KRS 45.640 and by such rules, regulations and orders issued pursuant thereto and will permit access to all books and records pertaining to his employment practices and work sites by the contracting agency and the department for purposes of investigation to ascertain compliance with KRS 45.560 to 45.640 and such rules, regulations and orders issued pursuant thereto.*

KRS 45.620. Action against contractor - Hiring of minority contractor or subcontractor

- (1) *If any contractor is found by the department to have engaged in an unlawful practice under this chapter during the course of performing under a contract or subcontract covered under KRS 45.560 to 45.640, the department shall so certify to the contracting agency and such certification shall be binding upon the contracting agency unless it is reversed in the course of judicial review.*
- (2) *If the contractor is found to have committed an unlawful practice under KRS 45.560 to 45.640, the contracting agency may cancel or terminate the contract, conditioned upon a program for future compliance approved by the contracting agency and the department. The contracting agency may declare such a contractor ineligible to bid on further contracts with that agency until such time as the contractor complies in full with the requirements of KRS 45.560 to 45.640.*
- (3) *The equal employment provisions of KRS 45.560 to 45.640 may be met in part by a contractor by subcontracting to a minority contractor or subcontractor. For the provisions of KRS 45.560 to 45.640, a minority contractor or subcontractor shall mean a business that is owned and controlled by one or more persons disadvantaged by racial or ethnic circumstances.*

KRS 45.630 Termination of existing employee not required, when

Any provision of KRS 45.560 to 45.640 notwithstanding, no contractor shall be required to terminate an existing employee upon proof that that employee was employed prior to the date of the contract.

KRS 45.640 Minimum skills

Nothing in KRS 45.560 to 45.640 shall require a contractor to hire anyone who fails to demonstrate the minimum skills required to perform a particular job.

It is recommended that all of the provisions above quoted to be included as special conditions in each contract. In the case of a contract exceeding \$250,000, the contractor is required to furnish evidence that his work-force in Kentucky is representative of the available work-force in the area from which he draws employees, or to supply an Affirmative Action plan which will achieve such representation during the life of the contract.

- U. Any party, firm or individual submitting a proposal pursuant to this invitation must be in compliance with the requirements of the Lexington-Fayette Urban County Government regarding taxes and fees before they can be considered for award of this invitation and must maintain a "current" status with regard to those taxes and fees throughout the term of the contract. The contractor must be in compliance with Chapter 13 from the Code of Ordinances of the Lexington-Fayette Urban County Government. The contractor must be in compliance with Ordinance 35-2000 pursuant to contractor registration with the Division of Building Inspection. If applicable, said business must have a Fayette County business license.

Pursuant to KRS 45A.343 and KRS 45A.345, the contractor shall

- (1) *Reveal any final determination of a violation by the contractor within the previous five year period pursuant to KRS Chapters 136 (corporation and utility taxes), 139 (sales and use taxes), 141 (income taxes), 337 (wages and hours), 338 (occupational safety and health of employees), 341 (unemployment and compensation) and 342 (labor and human rights) that apply to the contractor; and*
- (2) *Be in continuous compliance with the above-mentioned KRS provisions that apply to the contractor for the duration of the contract.*

A contractor's failure to reveal the above or to comply with such provisions for the duration of the contract shall be grounds for cancellation of the contract and disqualification of the contractor from eligibility for future contracts for a period of two (2) years.

- V. Vendors who respond to this invitation have the right to file a notice of contention associated with the bid process or to file a notice of appeal of the recommendation made by the Director of Central Purchasing resulting from this invitation.

Notice of contention with the bid process must be filed within 3 business days of the bid/proposal opening by (1) sending a written notice, including sufficient documentation to support contention, to the Director of the Division of Central Purchasing or (2) submitting a written request for a meeting with the Director of Central Purchasing to explain his/her contention with the bid process. After consulting with the Commissioner of Finance the Chief Administrative Officer and reviewing the documentation and/or hearing the vendor, the Director of Central Purchasing shall promptly respond in writing findings as to the compliance with bid processes. If, based on this review, a bid process irregularity is deemed to have occurred the Director of Central Purchasing will consult with the Commissioner of Finance, the Chief Administrative Officer and the Department of Law as to the appropriate remedy.

Notice of appeal of a bid recommendation must be filed within 3 business days of the bid recommendation by (1) sending a written notice, including sufficient documentation to support appeal, to the Director, Division of Central Purchasing or (2) submitting a written request for a meeting with the Director of Central Purchasing to explain his appeal. After reviewing the documentation and/or hearing the vendor and consulting with the Commissioner of Finance and the Chief Administrative Officer, the Director of Central Purchasing shall in writing, affirm or withdraw the recommendation.

III. Procurement Contract Bid Conditions

- A. The terms of this agreement shall be for 1 year(s) from the date of acceptance of this contract by the Lexington-Fayette Urban County Government. This agreement may be automatically extended for an additional **(2)-1** year(s) renewal. This contract may be canceled by either party thirty (30) days after delivery by canceling party of written notice of intent to cancel to the other contracting party.
- B. Price Changes **(Space Checked Applies)**
 - (XXX)1. Prices quoted in response to the Invitation shall be firm prices for the first 90 days of the Procurement Contract. After 90 days, prices may be subject to revision and such changes shall be based on general industry changes. Revision may be either increases or decreases and may be requested by either party. There will be no more than one (1) price adjustment per year. Requests for price changes shall be received in writing at least twenty (20) days prior to the effective date and are subject to written acceptance before becoming effective. Proof of the validity of a request for revision shall be responsibility of the requesting party. The Lexington-Fayette Urban County Government shall receive the benefit of any decline that the seller shall offer his other accounts.
 - () 2. No provision for price change is made herein. Prices are to be firm for the term of this contract.
 - () 3. See bid specifications.
- C. If any contract item is not available from the vendor, the Lexington-Fayette Urban County Government, at its option, may permit the item to be back-ordered or may procure the item on the open market.
- D. All invoices must bear reference to the Lexington-Fayette Urban County Government Purchasing document numbers which are being billed.
- E. This contract may be canceled by the Lexington-Fayette Urban County Government if it is determined that the Bidder has failed to perform under the terms of this agreement, such cancellation to be effective upon receipt of written notice of cancellation by the Bidder.
- F. No substitutions for articles specified herein may be made without prior approval of the Division of Central Purchasing.

EQUAL OPPORTUNITY AGREEMENT

Standard Title VI Assurance

The Lexington Fayette-Urban County Government, (hereinafter referred to as the "Recipient") hereby agrees that as a condition to receiving any Federal financial assistance from the U.S. Department of Transportation, it will comply with Title VI of the Civil Rights Act of 1964, 78Stat.252, 42 U.S.C. 2000d-4 (hereinafter referred to as the "Act"), and all requirements imposed by or pursuant to Title 49, Code of Federal Regulations, U.S. Department of Transportation, Subtitle A, Office of the Secretary, (49 CFR, Part 21) Nondiscrimination in Federally Assisted Program of the Department of Transportation – Effectuation of Title VI of the Civil Rights Act of 1964 (hereinafter referred to as the "Regulations") and other pertinent directives, no person in the United States shall, on the grounds of race, color, national origin, sex, age (over 40), religion, sexual orientation, gender identity, veteran status, or disability be excluded from participation in, be denied the benefits of, or be otherwise subjected to discrimination under any program or activity for which the Recipient receives Federal financial assistance from the U.S. Department of Transportation, including the Federal Highway Administration, and hereby gives assurance that will promptly take any necessary measures to effectuate this agreement. This assurance is required by subsection 21.7(a) (1) of the Regulations.

The Law

- Title VII of the Civil Rights Act of 1964 (amended 1972) states that it is unlawful for an employer to discriminate in employment because of race, color, religion, sex, age (40-70 years) or national origin.
- Executive Order No. 11246 on Nondiscrimination under Federal contract prohibits employment discrimination by contractor and sub-contractor doing business with the Federal Government or recipients of Federal funds. This order was later amended by Executive Order No. 11375 to prohibit discrimination on the basis of sex.
- Section 503 of the Rehabilitation Act of 1973 states: *The Contractor will not discriminate against any employee or applicant for employment because of physical or mental disability.*
- Section 2012 of the Vietnam Era Veterans Readjustment Act of 1973 requires Affirmative Action on behalf of disabled veterans and veterans of the Vietnam Era by contractors having Federal contracts.
- Section 206(A) of Executive Order 12086, Consolidation of Contract Compliance Functions for Equal Employment Opportunity, states: *The Secretary of Labor may investigate the employment practices of any Government contractor or sub-contractor to determine whether or not the contractual provisions specified in Section 202 of this order have been violated.*

The Lexington-Fayette Urban County Government practices Equal Opportunity in recruiting, hiring and promoting. It is the Government's intent to affirmatively provide employment opportunities for those individuals who have previously not been allowed to enter into the mainstream of society. Because of its importance to the local Government, this policy carries the full endorsement of the Mayor, Commissioners, Directors and all supervisory personnel. In following this commitment to Equal Employment Opportunity and because the Government is the benefactor of the Federal funds, it is both against the Urban County Government policy and illegal for the Government to let contracts to companies which knowingly or unknowingly practice discrimination in their employment practices. Violation of the above mentioned ordinances may cause a contract to be canceled and the contractors may be declared ineligible for future consideration.

Please sign this statement in the appropriate space acknowledging that you have read and understand the provisions contained herein. Return this document as part of your application packet.

Bidders

I/We agree to comply with the Civil Rights Laws listed above that govern employment rights of minorities, women, veteran status, disability and age.

Signature

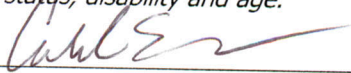

J. Edinger & Son, Inc.
Name of Business

GENERAL PROVISIONS OF BID CONTRACT

By signing the below, bidder acknowledges that it understands and agrees with the following provisions related to its bid response and the provision of any goods or services to LFUCG upon selection by LFUCG pursuant to the bid request:

1. Bidder shall comply with all Federal, State & Local regulations concerning this type of service or good. All applicable state laws, ordinances and resolutions (including but not limited to Section 2-33 (Discrimination due to sexual orientation or gender identity) and Chapter 13 (Licenses and Regulations) of the Lexington-Fayette Urban County Government Code of Ordinances, and Resolution No. 484-17 (Minority, Women, and Veteran-Owned Businesses)) and the regulations of all authorities having jurisdiction over the project shall apply to the contract, and shall be deemed to be incorporated herein by reference.
2. Failure to submit ALL forms and information required by LFUCG may be grounds for disqualification.
3. Addenda: All addenda and IonWave Q&A, if any, must be considered by the bidder in making its response, and such addenda shall be made a part of the requirements of the bid contract. Before submitting a bid response, it is incumbent upon bidder to be informed as to whether any addenda have been issued, and the failure of the bidder to cover any such addenda may result in disqualification of that response.
4. Bid Reservations: LFUCG reserves the right to reject any or all bid responses, to award in whole or part, and to waive minor immaterial defects in proposals. LFUCG may consider any alternative proposal that meets its basic needs.
5. Liability: LFUCG is not responsible for any cost incurred by bidder in the preparation of its response.
6. Changes/Alterations: Bidder may change or withdraw a proposal at any time prior to the opening; however, no oral modifications will be allowed. Only letters, or other formal written requests for modifications or corrections of a previously submitted proposal which is addressed in the same manner as the bid response, and received by LFUCG prior to the scheduled closing time for receipt of bids, will be accepted. The bid response when opened, will then be corrected in accordance with such written request(s), provided that the written request is contained in a sealed envelope which is plainly marked "modifications of bid response".
7. Clarification of Submittal: LFUCG reserves the right to obtain clarification of any point in a bid or to obtain additional information from any bidder.
8. Bribery Clause: By his/her signature on its response, bidder certifies that no employee of his/hers, any affiliate or subcontractor, has bribed or attempted to bribe an officer or employee of the LFUCG.
9. Additional Information: While not necessary, the bidder may include any product brochures, software documentation, sample reports, or other documentation that may assist LFUCG in better understanding and evaluating the bid response. Additional documentation shall not serve as a substitute for other documentation which is required by the LFUCG to be submitted with the bid response.
10. Ambiguity, Conflict or other Errors: If a bidder discovers any ambiguity, conflict, discrepancy, omission or other error in the bid request of LFUCG, it shall immediately notify LFUCG of such error in writing and request modification or clarification of the document if allowable by the LFUCG.
11. Agreement to Bid Terms: In submitting its bid response, the bidder agrees that it has carefully examined the specifications and all provisions relating to LFUCG's bid request, including but not limited to the bid contract. By submission of its bid response, bidder states that it understands the meaning, intent and requirements of LFUCG's bid request and agrees to the same. The successful bidder shall warrant that it is familiar with and understands all provisions herein and shall warrant that it can comply with them. No additional compensation to bidder shall be authorized for services, expenses, or goods reasonably covered under these provisions that the bidder omits from its bid response.
12. Cancellation: LFUCG may unilaterally terminate the bid contract with the selected bidder(s) at any time, with or without cause, by providing at least thirty (30) days advance written notice unless a different advance written notice period is negotiated prior to contract approval. Payment for services or goods received prior to

termination shall be made by the LFUCG provided these goods or services were provided in a manner acceptable to the LFUCG. Payment for those goods and services shall not be unreasonably withheld.

13. Assignment of Contract: The selected bidder(s) shall not assign or subcontract any portion of the bid contract with LFUCG without the express written consent of LFUCG. Any purported assignment or subcontract in violation hereof shall be void. It is expressly acknowledged that LFUCG shall never be required or obligated to consent to any request for assignment or subcontract; and further that such refusal to consent can be for any or no reason, fully within the sole discretion of LFUCG.
14. No Waiver: No failure or delay by LFUCG in exercising any right, remedy, power or privilege hereunder, nor any single or partial exercise thereof, nor the exercise of any other right, remedy, power or privilege shall operate as a waiver hereof or thereof. No failure or delay by LFUCG in exercising any right, remedy, power or privilege under or in respect of this bid proposal or bid contract shall affect the rights, remedies, powers or privileges of LFUCG hereunder or shall operate as a waiver thereof.
15. Authority to do Business: Each bidder must be authorized to do business under the laws of the Commonwealth of Kentucky and must be in good standing and have full legal capacity to provide the goods or services specified in the bid proposal. Each bidder must have all necessary right and lawful authority to submit the bid response and enter into the bid contract for the full term hereof including any necessary corporate or other action authorizing the bidder to submit the bid response and enter into this bid contract. If requested, the bidder will provide LFUCG with a copy of a corporate resolution authorizing this action and/or a letter from an attorney confirming that the proposer is authorized to do business in the Commonwealth of Kentucky. All bid responses must be signed by a duly authorized officer, agent or employee of the bidder.
16. Governing Law: This bid request and bid contract shall be governed by and construed in accordance with the laws of the Commonwealth of Kentucky. In the event of any proceedings regarding this matter, the bidder agrees that the venue shall be the Fayette County Circuit Court or the U.S. District Court for the Eastern District of Kentucky, Lexington Division and that the bidder expressly consents to personal jurisdiction and venue in such Court for the limited and sole purpose of proceedings relating to these matters or any rights or obligations arising thereunder.
17. Ability to Meet Obligations: Bidder affirmatively states that there are no actions, suits or proceedings of any kind pending against bidder or, to the knowledge of the bidder, threatened against the bidder before or by any court, governmental body or agency or other tribunal or authority which would, if adversely determined, have a materially adverse effect on the authority or ability of bidder to perform its obligations under this bid response or bid contract, or which question the legality, validity or enforceability hereof or thereof.
18. Price Discrepancy: When applicable, in case of price discrepancy, unit bid price written in words will prevail followed by unit price written in numbers then total amount bid per line item.
19. Bidder understands and agrees that its employees, agents, or subcontractors are not employees of LFUCG for any purpose whatsoever. Bidder is an independent contractor at all times related to the bid response or bid contract.
20. Contractor [or Vendor or Vendor's Employees] will not appropriate or make use of the Lexington-Fayette Urban County Government (LFUCG) name or any of its trade or service marks or property (including but not limited to any logo or seal), in any promotion, endorsement, advertisement, testimonial or similar use without the prior written consent of the government. If such consent is granted LFUCG reserves the unilateral right, in its sole discretion, to immediately terminate and revoke such use for any reason whatsoever. Contractor agrees that it shall cease and desist from any unauthorized use immediately upon being notified by LFUCG.
21. If any term or provision of this bid contract shall be found to be illegal or unenforceable, the remainder of the contract shall remain in full force and such term or provision shall be deemed stricken.

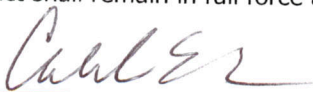
Signature

03/15/2021
Date

WORKFORCE ANALYSIS FORM

Name of Organization: J. Edinger & Son, Inc.

Categories	Total	White (Not Hispanic or Latino)		Hispanic or Latino		Black or African-American (Not Hispanic or Latino)		Native Hawaiian and Other Pacific Islander (Not Hispanic or Latino)		Asian (Not Hispanic or Latino)		American Indian or Alaskan Native (not Hispanic or Latino)		Two or more races (Not Hispanic or Latino)		Total		
		M	F	M	F	M	F	M	F	M	F	M	F	M	F	M	F	
Administrators		1															1	
Professionals																		
Superintendents		1															1	
Supervisors																		
Foremen																		
Technicians																		
Protective Service																		
Para-Professionals																		
Office/Clerical		2	1														2	1
Skilled Craft		2		8													10	
Service/Maintenanc																		
Total:		6	1	8													14	1

Prepared by: Vickie Haven
(Name and Title)

Date: 03 / 15 / 2021

Revised 2015-Dec-15

**DIRECTOR, DIVISION OF CENTRAL PURCHASING
LEXINGTON-FAYETTE URBAN COUNTY GOVERNMENT
200 EAST MAIN STREET
LEXINGTON, KENTUCKY 40507**

**NOTICE OF REQUIREMENT FOR AFFIRMATIVE ACTION TO ENSURE
EQUAL EMPLOYMENT OPPORTUNITIES AND DBE CONTRACT PARTICIPATION**

The Lexington-Fayette Urban County Government has set a goal that not less than ten percent (10%) of the total value of this contract be subcontracted to MBE/WBE's, and set a goal that not less than three percent (3%) of the total value of this contract be subcontracted to Veteran-Owned Small Businesses. The goal for the utilization of Certified MBE/WBE's and Veteran-Owned Small Businesses as subcontractors are recommended goals. Contractors who fail to meet such goals will be expected to provide written explanations to the Director of the Division of Central Purchasing of efforts they have made to accomplish the recommended goals and the extent to which they are successful in accomplishing the recommended goals will be a consideration in the procurement process.

For assistance in locating MBE/WBE Subcontractors contact Sherita Miller at 859/258-3320 or by writing the address listed below:

Sherita Miller, Division of Central Purchasing
Lexington-Fayette Urban County Government
200 East Main Street – Room 338
Lexington, Kentucky 40507
smiller@lexingtonky.gov

DOES NOT APPLY - WORK NOT SUBCONTRACTED

Lexington-Fayette Urban County Government
MWDBE PARTICIPATION GOALS

A. GENERAL

- 1) The LFUCG request all potential contractors to make a concerted effort to include Minority-Owned (MBE), Woman-Owned (WBE), Disadvantaged (DBE) Business Enterprises and Veteran-Owned Small Businesses (VOSB) as subcontractors or suppliers in their bids.
- 2) Toward that end, the LFUCG has established 10% of total procurement costs as a Goal for participation of Minority-Owned, Woman-Owned and Disadvantaged Businesses on this contract.
- 3) **It is therefore a request of each Bidder to include in its bid, the same goal (10%) for MWDBE participation and other requirements as outlined in this section.**
- 4) The LFUCG has also established a 3% of total procurement costs as a Goal for participation for of Veteran-Owned Businesses.
- 5) **It is therefore a request of each Bidder to include in its bid, the same goal (3%) for Veteran-Owned participation and other requirements as outlined in this section.**

B. PROCEDURES

- 1) The successful bidder will be required to report to the LFUCG, the dollar amounts of all payments submitted to Minority-Owned, Woman-Owned or Veteran-Owned subcontractors and suppliers for work done or materials purchased for this contract. (See Subcontractor Monthly Payment Report)
- 2) Replacement of a Minority-Owned, Woman-Owned or Veteran-Owned subcontractor or supplier listed in the original submittal must be requested in writing and must be accompanied by documentation of Good Faith Efforts to replace the subcontractor / supplier with another MWDBE Firm; this is subject to approval by the LFUCG. (See LFUCG MWDBE Substitution Form)
- 3) For assistance in identifying qualified, certified businesses to solicit for potential contracting opportunities, bidders may contact:
 - a) The Lexington-Fayette Urban County Government, Division of Central Purchasing (859-258-3320)
- 4) The LFUCG will make every effort to notify interested MWDBE and Veteran-Owned subcontractors and suppliers of each Bid Package, including information on the scope of work, the pre-bid meeting time and location, the bid date, and all other pertinent information regarding the project.

C. DEFINITIONS

- 1) A Minority-Owned Business Enterprise (MBE) is defined as a business which is certified as being at least 51% owned, managed and controlled by persons of African American, Hispanic, Asian, Pacific Islander, American Indian or Alaskan Native Heritage.
- 2) A Woman-Owned Business Enterprise (WBE) is defined as a business which is certified as being at least 51% owned, managed and controlled by one or more women.

- 3) A Disadvantaged Business (DBE) is defined as a business which is certified as being at least 51% owned, managed and controlled by a person(s) that are economically and socially disadvantaged.
- 4) A Veteran-Owned Small Business (VOSB) is defined as a business which is certified as being at least 51% owned, managed and controlled by a veteran and/or a service disabled veteran.
- 5) Good Faith Efforts are efforts that, given all relevant circumstances, a bidder or proposer actively and aggressively seeking to meet the goals, can reasonably be expected to make. In evaluating good faith efforts made toward achieving the goals, whether the bidder or proposer has performed the efforts outlined in the Obligations of Bidder for Good Faith Efforts outlined in this document will be considered, along with any other relevant factors.

D. OBLIGATION OF BIDDER FOR GOOD FAITH EFFORTS

- 1) **The bidder shall make a Good Faith Effort to achieve the Participation Goal for MWDBE and Veteran-Owned subcontractors/suppliers. The failure to meet the goal shall not necessarily be cause for disqualification of the bidder; however, bidders not meeting the goal are required to furnish with their bids written documentation of their Good Faith Efforts to do so.**
- 2) Award of Contract shall be conditioned upon satisfaction of the requirements set forth herein.
- 3) The Form of Proposal includes a section entitled "MWDBE Participation Form". The applicable information must be completed and submitted as outlined below.
- 4) **Failure to submit this information as requested may be cause for rejection of bid or delay in contract award.**

E. DOCUMENTATION REQUIRED FOR GOOD FAITH EFFORTS

- 1) Bidders reaching the Goal are required to submit only the MWDBE Participation Form." The form must be fully completed including names and telephone number of participating MWDBE firm(s); type of work to be performed; estimated value of the contract and value expressed as a percentage of the total Lump Sum Bid Price. The form must be signed and dated, and is to be submitted with the bid.
- 2) Bidders not reaching the Goal must submit the "MWDBE Participation Form", the "Quote Summary Form" and a written statement documenting their Good Faith Effort to do so. If bid includes no MWDBE and/or Veteran participation, bidder shall enter "None" on the subcontractor / supplier form). In addition, the bidder must submit written proof of their Good Faith Efforts to meet the Participation Goal:
 - a. Advertised opportunities to participate in the contract in at least two (2) publications of general circulation media; trade and professional association publications; small and minority business or trade publications; and publications or trades targeting minority, women and disadvantaged businesses not less than fifteen (15) days prior to the deadline for submission of bids to allow MWDBE firms and Veteran-Owned businesses to participate.
 - b. Included documentation of advertising in the above publications with the bidders good faith efforts package
 - c. Attended LFUCG Central Purchasing Economic Inclusion Outreach event

- d. Attended pre-bid meetings that were scheduled by LFUCG to inform MWDBEs and/or Veteran-Owned businesses of subcontracting opportunities
- e. Sponsored Economic Inclusion event to provide networking opportunities for prime contractors and MWDBE firms and Veteran-Owned businesses.
- f. Requested a list of MWDBE and/or Veteran subcontractors or suppliers from LFUCG and showed evidence of contacting the companies on the list(s).
- g. Contacted organizations that work with MWDBE companies for assistance in finding certified MWDBE firms and Veteran-Owned businesses to work on this project. Those contacted and their responses should be a part of the bidder's good faith efforts documentation.
- h. Sent written notices, by certified mail, email or facsimile, to qualified, certified MWDBEs and/or Veteran-Owned businesses soliciting their participation in the contract not less than seven (7) days prior to the deadline for submission of bids to allow them to participate effectively.
- i. Followed up initial solicitations by contacting MWDBEs and Veteran-Owned Businesses to determine their level of interest.
- j. Provided the interested MWDBE firm and/or Veteran-Owned business with adequate and timely information about the plans, specifications, and requirements of the contract.
- k. Selected portions of the work to be performed by MWDBE firms and/or Veteran-Owned businesses in order to increase the likelihood of meeting the contract goals. This includes, where appropriate, breaking out contract work items into economically feasible units to facilitate MWDBE and Veteran participation, even when the prime contractor may otherwise perform these work items with its own workforce
- l. Negotiated in good faith with interested MWDBE firms and Veteran-Owned businesses not rejecting them as unqualified without sound reasons based on a thorough investigation of their capabilities. Any rejection should be so noted in writing with a description as to why an agreement could not be reached.
- m. Included documentation of quotations received from interested MWDBE firms and Veteran-Owned businesses which were not used due to uncompetitive pricing or were rejected as unacceptable and/or copies of responses from firms indicating that they would not be submitting a bid.
- n. Bidder has to submit sound reasons why the quotations were considered unacceptable. The fact that the bidder has the ability and/or desire to perform the contract work with its own forces will not be considered a sound reason for rejecting a MWDBE and/or Veteran-Owned business's quote. Nothing in this provision shall be construed to require the bidder to accept unreasonable quotes in order to satisfy MWDBE and Veteran goals.
- o. Made an effort to offer assistance to or refer interested MWDBE firms and Veteran-Owned businesses to obtain the necessary equipment, supplies, materials, insurance and/or bonding

to satisfy the work requirements of the bid proposal

p. Made efforts to expand the search for MWBE firms and Veteran-Owned businesses beyond the usual geographic boundaries.

q. Other--any other evidence that the bidder submits which may show that the bidder has made reasonable good faith efforts to include MWDBE and Veteran participation.

Note: Failure to submit any of the documentation requested in this section may be cause for rejection of bid. Bidders may include any other documentation deemed relevant to this requirement which is subject to review by the MBE Liaison. Documentation of Good Faith Efforts must be submitted with the Bid, if the participation Goal is not met.



MINORITY BUSINESS ENTERPRISE PROGRAM

Sherita Miller, MPA
Minority Business Enterprise Liaison
Division of Central Purchasing
Lexington-Fayette Urban County Government
200 East Main Street
Lexington, KY 40507
smiller@lexingtonky.gov
859-258-3323

OUR MISSION: The mission of the Minority Business Enterprise Program is to facilitate the full participation of minority and women owned businesses in the procurement process and to promote economic inclusion as a business imperative essential to the long term economic viability of Lexington-Fayette Urban County Government.

To that end the city council adopted and implemented Resolution 484-2017 – A Certified Minority, Women and Disadvantaged Business Enterprise ten percent (10%) minimum goal and a three (3%) minimum goal for Certified Veteran-Owned Small Businesses and Certified Service Disabled Veteran – Owned Businesses for government contracts.

The resolution states the following definitions shall be used for the purposes of reaching these goals (a full copy is available in Central Purchasing):

Certified Disadvantaged Business Enterprise (DBE) – a business in which at least fifty-one percent (51%) is owned, managed and controlled by a person(s) who is socially and economically disadvantaged as defined by 49 CFR subpart 26.

Certified Minority Business Enterprise (MBE) – a business in which at least fifty-one percent (51%) is owned, managed and controlled by an ethnic minority (i.e. African American, Asian American/Pacific Islander, Hispanic Islander, Native American/Native Alaskan Indian) as defined in federal law or regulation as it may be amended from time-to-time.

Certified Women Business Enterprise (WBE) – a business in which at least fifty-one percent (51%) is owned, managed and controlled by a woman.

Certified Veteran-Owned Small Business (VOSB) – a business in which at least fifty-one percent (51%) is owned, managed and controlled by a veteran who served on active duty with the U.S. Army, Air Force, Navy, Marines or Coast Guard.

Certified Service Disabled Veteran Owned Small Business (SDVOSB) – a business in which at least fifty-one percent (51%) is owned, managed and controlled by a disabled veteran who served on active duty with the U.S. Army, Air Force, Navy, Marines or Coast Guard.

The term “Certified” shall mean the business is appropriately certified, licensed, verified, or validated by an organization or entity recognized by the Division of Purchasing as having the appropriate credentials to make a determination as to the status of the business.

To comply with Resolution 484-2017, prime contractors and minority, women and veteran owned businesses must enroll in the new Diverse Business Management Compliance system, <https://lexingtonky.diversitycompliance.com/>

We have compiled the list below to help you locate certified MBE, WBE and DBE certified businesses. Below is a listing of contacts for LFUCG Certified MWDBEs and Veteran-Owned Small Businesses in (<https://lexingtonky.ionwave.net>)

Business	Contact	Email Address	Phone
LFUCG	Sherita Miller	smiller@lexingtonky.gov	859-258-3323
Commerce Lexington – Minority Business Development	Tyrone Tyra	ttyra@commercelexington.com	859-226-1625
Tri-State Minority Supplier Diversity Council	Susan Marston	smarston@tsmsdc.com	502-365-9762
Small Business Development Council	Shawn Rogers UK SBDC	shawn.rogers@uky.edu	859-257-7666
Community Ventures Corporation	Phyllis Alcorn	palcorn@cvky.org	859-231-0054
KY Transportation Cabinet (KYTC)	Melvin Bynes	Melvin.bynes2@ky.gov	502-564-3601
KYTC Pre-Qualification	Shella Eagle	Shella.Eagle@ky.gov	502-782-4815
Ohio River Valley Women’s Business Council (WBENC)	Sheila Mixon	smixon@orvwbc.org	513-487-6537
Kentucky MWBE Certification Program	Yvette Smith, Kentucky Finance Cabinet	Yvette.Smith@ky.gov	502-564-8099
National Women Business Owner’s Council (NWBOC)	Janet Harris-Lange	janet@nwboe.org	800-675-5066
Small Business Administration	Robert Coffey	robertcoffey@sba.gov	502-582-5971
LaVoz de Kentucky	Andres Cruz	lavozdeky@yahoo.com	859-621-2106
The Key News Journal	Patrice Muhammad	production@keynewsjournal.com	859-685-8488



LFUCG MWDBE PARTICIPATION FORM

Bid/RFP/Quote Reference # _____

The MWDBE and/or veteran subcontractors listed have agreed to participate on this Bid/RFP/Quote. If any substitution is made or the total value of the work is changed prior to or after the job is in progress, it is understood that those substitutions must be submitted to Central Purchasing for approval immediately. **Failure to submit a completed form may cause rejection of the bid.**

MWDBE Company, Name, Address, Phone, Email	MBE WBE or DBE	Work to be Performed	Total Dollar Value of the Work	% Value of Total Contract
1.				
2.				
3.				
4.				

The undersigned company representative submits the above list of MWDBE firms to be used in accomplishing the work contained in this Bid/RFP/Quote. Any misrepresentation may result in the termination of the contract and/or be subject to applicable Federal and State laws concerning false statements and false claims.

Company

Company Representative

Date

Title



LEXINGTON

LFUCG MWDBE PARTICIPATION FORM

Bid/RFP/Quote Reference # _____

The MWDBE and/or veteran subcontractors listed have agreed to participate on this Bid/RFP/Quote. If any substitution is made or the total value of the work is changed prior to or after the job is in progress, it is understood that those substitutions must be submitted to Central Purchasing for approval immediately. **Failure to submit a completed form may cause rejection of the bid.**

MWDBE Company, Name, Address, Phone, Email	MBE WBE or DBE	Work to be Performed	Total Dollar Value of the Work	% Value of Total Contract
1.				
2.				
3.				
4.				

The undersigned company representative submits the above list of MWDBE firms to be used in accomplishing the work contained in this Bid/RFP/Quote. Any misrepresentation may result in the termination of the contract and/or be subject to applicable Federal and State laws concerning false statements and false claims.

Company

Company Representative

Date

Title



LEXINGTON

LFUCG MWDBE SUBSTITUTION FORM

Bid/RFP/Quote Reference # _____

The substituted MWDBE and/or veteran subcontractors listed below have agreed to participate on this Bid/RFP/Quote. These substitutions were made prior to or after the job was in progress. These substitutions were made for reasons stated below and are now being submitted to Central Purchasing for approval. By the authorized signature of a representative of our company, we understand that this information will be entered into our file for this project. **Failure to submit this form may cause rejection of the bid.**

SUBSTITUTED MWDBE Company Name, Address, Phone, Email	MWDBE Formally Contracted/ Name, Address, Phone, Email	Work to Be Performed	Reason for the Substitution	Total Dollar Value of the Work	% Value of Total Contract
1.					
2.					
3.					
4.					

The undersigned acknowledges that any misrepresentation may result in termination of the contract and/or be subject to applicable Federal and State laws concerning false statements and false claims.

Company

Company Representative

Date

Title



LEXINGTON

MWDBE QUOTE SUMMARY FORM

Bid/RFP/Quote Reference # _____

The undersigned acknowledges that the minority and/or veteran subcontractors listed on this form did submit a quote to participate on this project. Failure to submit this form may cause rejection of the bid.

Company Name	Contact Person
Address/Phone/Email	Bid Package / Bid Date

MWDBE Company Address	Contact Person	Contact Information (work phone Email, cell)	Date Contacted	Services to be performed	Method of Communication (email, phone meeting, ad, event etc)	Total dollars \$\$ Do Not Leave Blank (Attach Documentation)	MBE * AA HA AS NA Female	Veteran

(MBE designation / AA=African American / HA= Hispanic American/AS = Asian American/Pacific Islander/ NA= Native American)

The undersigned acknowledges that all information is accurate. Any misrepresentation may result in termination of the contract and/or be subject to applicable Federal and State laws concerning false statements and claims.

Company

Company Representative

Date

Title



LEXINGTON

LFUCG SUBCONTRACTOR MONTHLY PAYMENT REPORT

The LFUCG has a 10% goal plan adopted by city council to increase the participation of minority and women owned businesses in the procurement process. The LFUCG also has a 3% goal plan adopted by cited council to increase the participation of veteran owned businesses in the procurement process. In order to measure that goal LFUCG will track spending with MWDBE and Veteran contractors on a monthly basis. By the signature below of an authorized company representative, you certify that the information is correct, and that each of the representations set forth below is true. Any misrepresentation may result in termination of the contract and/or prosecution under applicable Federal and State laws concerning false statements and false claims. Please submit this form monthly to the Division of Central Purchasing/ 200 East Main Street / Room 338 / Lexington, KY 40507.

Bid/RFP/Quote # _____

Total Contract Amount Awarded to Prime Contractor for this Project _____

Project Name/ Contract #	Work Period/ From: _____ To: _____
Company Name:	Address: _____
Federal Tax ID:	Contact Person: _____

Subcontractor Vendor ID (name, address, phone, email)	Description of Work	Total Subcontract Amount	% of Total Contract Awarded to Prime for this Project	Total Amount Paid for this Period	Purchase Order number for subcontractor work (please attach PO)	Scheduled Project Start Date	Scheduled Project End Date

By the signature below of an authorized company representative, you certify that the information is correct, and that each of the representations set forth below is true. Any misrepresentations may result in the termination of the contract and/or prosecution under applicable Federal and State laws concerning false statements and false claims.

Company

Company Representative

Date

Title

LFUCG STATEMENT OF GOOD FAITH EFFORTS

Bid/RFP/Quote # _____

By the signature below of an authorized company representative, we certify that we have utilized the following Good Faith Efforts to obtain the maximum participation by MWDBE and Veteran-Owned business enterprises on the project and can supply the appropriate documentation.

_____ Advertised opportunities to participate in the contract in at least two (2) publications of general circulation media; trade and professional association publications; small and minority business or trade publications; and publications or trades targeting minority, women and disadvantaged businesses not less than fifteen (15) days prior to the deadline for submission of bids to allow MWDBE firms and Veteran-Owned businesses to participate.

_____ Included documentation of advertising in the above publications with the bidders good faith efforts package

_____ Attended LFUCG Central Purchasing Economic Inclusion Outreach event

_____ Attended pre-bid meetings that were scheduled by LFUCG to inform MWDBEs and/or Veteran-Owned Businesses of subcontracting opportunities

_____ Sponsored Economic Inclusion event to provide networking opportunities for prime contractors and MWDBE firms and Veteran-Owned businesses

_____ Requested a list of MWDBE and/or Veteran subcontractors or suppliers from LFUCG and showed evidence of contacting the companies on the list(s).

_____ Contacted organizations that work with MWDBE companies for assistance in finding certified MWBDE firms and Veteran-Owned businesses to work on this project. Those contacted and their responses should be a part of the bidder's good faith efforts documentation.

_____ Sent written notices, by certified mail, email or facsimile, to qualified, certified MWDBEs soliciting their participation in the contract not less than seven (7) days prior to the deadline for submission of bids to allow them to participate effectively.

_____ Followed up initial solicitations by contacting MWDBEs and Veteran-Owned businesses to determine their level of interest.

_____ Provided the interested MWBDE firm and/or Veteran-Owned business with adequate and timely information about the plans, specifications, and requirements of the contract.

_____ Selected portions of the work to be performed by MWDBE firms and/or Veteran-Owned businesses in order to increase the likelihood of meeting the contract goals. This includes, where appropriate, breaking out contract work items into economically feasible units to facilitate MWDBE and Veteran participation, even when the prime contractor may otherwise perform these work items with its own workforce

_____ Negotiated in good faith with interested MWDBE firms and Veteran-Owned businesses not rejecting them as unqualified without sound reasons based on a thorough investigation of their capabilities. Any rejection should be so noted in writing with a description as to why an agreement could not be reached.

_____ Included documentation of quotations received from interested MWDBE firms and Veteran-Owned businesses which were not used due to uncompetitive pricing or were rejected as unacceptable and/or copies of responses from firms indicating that they would not be submitting a bid.

_____ Bidder has to submit sound reasons why the quotations were considered unacceptable. The fact that the bidder has the ability and/or desire to perform the contract work with its own forces will not be considered a sound reason for rejecting a MWDBE and/or Veteran-Owned business's quote. Nothing in this provision shall be construed to require the bidder to accept unreasonable quotes in order to satisfy MWDBE and Veteran goals.

_____ Made an effort to offer assistance to or refer interested MWDBE firms and Veteran-Owned businesses to obtain the necessary equipment, supplies, materials, insurance and/or bonding to satisfy the work requirements of the bid proposal

_____ Made efforts to expand the search for MWBE firms and Veteran-Owned businesses beyond the usual geographic boundaries.

_____ Other--any other evidence that the bidder submits which may show that the bidder has made reasonable good faith efforts to include MWDBE **and Veteran participation.**

NOTE: Failure to submit any of the documentation requested in this section may be cause for rejection of bid. Bidders may include any other documentation deemed relevant to this requirement which is subject to approval by the MBE Liaison. Documentation of Good Faith Efforts must be submitted with the Bid, if the participation Goal is not met.

The undersigned acknowledges that all information is accurate. Any misrepresentations may result in termination of the contract and/or be subject to applicable Federal and State laws concerning false statements and claims.

Company

Company Representative

Date

Title

1. SCOPE AND CLASSIFICATION

- 1.1 This specification describes the minimum requirements for a Flink power reversing snowplow model #559SUS4 with nominal dimensions of ten feet long (10'L) X forty two inches tall (42"T) with a push frame series hitch.

2. REQUIREMENTS

- 2.1 MOLDBOARD: Finished moldboard assembly shall have a usable height of at least forty two inches (42") but not more than forty-four inches (44"). Length shall be ten feet (10'). Backside of moldboard shall be reinforced by at least eight (8) vertical ribs, ½" X 3", formed to the full height of the plow. Moldboard shall be plated with 304 stainless steel, minimum thickness of 9/64" (10 ga).
 - 2.1.1 Shape and contour of moldboard assembly shall provide an integral snow deflector or shield along the top edge. This effect shall be enhanced by the installation of a field replaceable rubber deflector as a continuation of the integral deflector. The rubber deflector shall be designed and constructed to yield under heavy snow loading.
 - 2.1.2 Moldboard shall include a field replaceable, carbon steel edged, cutting edge such as Kennametal or equal. Cutting edge shall consist of 4 pieces a minimum of 2' and a maximum of 3' in length.
- 2.2 PUSH TABLE: The push table and associated plow frame structures shall be designed and built to withstand the rigors of continuous municipal plowing. Primary structural member shall consist of four (4) inch square steel tubing, with a wall thickness of 3/8 inch. Design shall allow for hydraulic power angling through the use of two (2) double acting hydraulic cylinders with a minimum bore diameter of three inches (3").
- 2.3 TRIP FUNCTION: A four (4) piece sectional trip device shall be provided to allow the lower plow section to trip independently of the moldboard in 2' of 3' lengths. Blade hinges are reinforced weldment type and each weldment is supported by two (2) trip springs with reverse wound springs inside main spring. The tripping action of the cutting edge is adjustable for tension, cutting edge angle and pitch. The upper hinge members are attached to the moldboard section with minimum 5/8 " x 2" carriage bolts (Grade 8) and welds. Upper hinge members are made of heat-treated cast steel and must be individually replaceable. The hinge pins are triple heat-treated special 5/8" x 3-1/4" bolts secured in place by slotted nuts and cotter pins. The plow may be equipped with either sectional type or one-piece cutting edge 5/8" x 6" with holes punched on AASHO centers 1-1/2" from the top edge to permit all wear to be taken from one edge, thus allowing 3-1/4" of wear from a 6" cutting edge.
- 2.4 CASTERS: Two (2) heavy duty, full swiveling, screw adjustable caster assemblies shall be installed. Caster wheels shall be supported by tapered roller bearings and caster assembly shall include shock absorbing springs. Steel caster wheels shall be provided with pneumatic tires. Wear points of caster assemblies shall be provided with grease fittings.
- 2.5 CUSHION VALVE: A valve shall be included to provide hydraulic cushioning and protection for the hydraulic cylinders.
- 2.6 CURB SHOES: Plow shall be equipped with curb guards on each side to prevent wear and damage of the cutting edge when plowing next to curbs and islands.

2.7 PUSH FRAME/HITCH: A heavy duty push frame/hitch assembly model #PF106FDAQL-2LMHP shall be provided as the interface between the truck and the snow plow assembly. Hitch shall be specifically designed and constructed for quick connection and disconnection of the plow assembly by driving the truck into the plow. Hitch shall be provided with a double acting hydraulic cylinder with a minimum bore diameter of three inches (3") and lift arm to raise the plow assembly. Plow and hitch design shall allow the plow to follow the contours of the road surface.

2.7.1 QUICK LATCH: The quick latch system shall be constructed so as all structural members of the box portion to be minimum one half inch (1/2") steel. Two (2) latch plates shall be minimum one inch (1"), T-1 type A plate steel. Latches shall be machined for three quarter inch (3/4") 304 stainless steel lock pins. The lock assembly shall be operated by a single spring loaded lever. The spring loaded lock assemblies shall lock the latches closed automatically when the plow is hitched to the truck. There shall be one half inch (1/2") formed guide plates to align swivel bar when driving into the plow.

2.8 Each plow shall be furnished with an operator's and parts manual.

3. NOTES

3.1 Unless replaced by optional equipment specified herein, all items shall retain standard features and equipment as shown on manufacturer's website and in published literature.

3.2 All items provided under this specification shall fully comply with any and all applicable OSHA and ANSI standards as well as all applicable Federal, State, and Local laws, regulations, ordinances, statutes, resolutions, and codes at time of delivery.

3.3 Manufacturers printed literature, which shall include complete specifications, warranty, descriptive text and photographs, shall be submitted with the bid and becomes an integral part of the bid. If submitted literature does not indicate compliance with the specifications and your firm can meet these specifications by modification, you must fully describe the modifications on a separate page titled "EXCEPTIONS". Exception page(s) shall be submitted with bid and become an integral part of bid.

3.4 Plow assemblies described herein are to be mounted on 44,000 lb. GVW Kenworth T470 trucks by LFUCG personnel. Hydraulic power for plow functions shall be provided by the truck.

3.5 All items furnished shall be new and unused, current model production.

4. DELIVERY

4.1 Bid prices shall be FOB LFUCG Division of Fleet Services facility, 669 Byrd Thurman Drive, Lexington, Ky. 40510. Upon delivery, units shall be physically inspected by LFUCG personnel prior to acceptance. Appropriate measurements may be taken to insure compliance with specifications. Any item or items found to be non-compliant with these specifications for which no exception was taken in the bid, can be used as grounds for refusal of delivery and payment.

5. METHOD of AWARD

- 5.1 A price contract will be awarded to the responsive and responsible bidder(s) who most successfully demonstrate the ability to provide the items described herein at the lowest unit price. The issuance of a price contract does not obligate the LFUCG for any purchases, quantities, or amounts. Price contract is subject to two (2) annual renewals if both parties agree. One (1) annual request for increase in contract price increase will be considered when accompanied by appropriate justification supporting the amount of increase. Price increases will be granted at the sole discretion of the LFUCG.



BAKER/FLINK 500 REVERSIBLE PLOW

THE OPERATOR'S CHOICE!

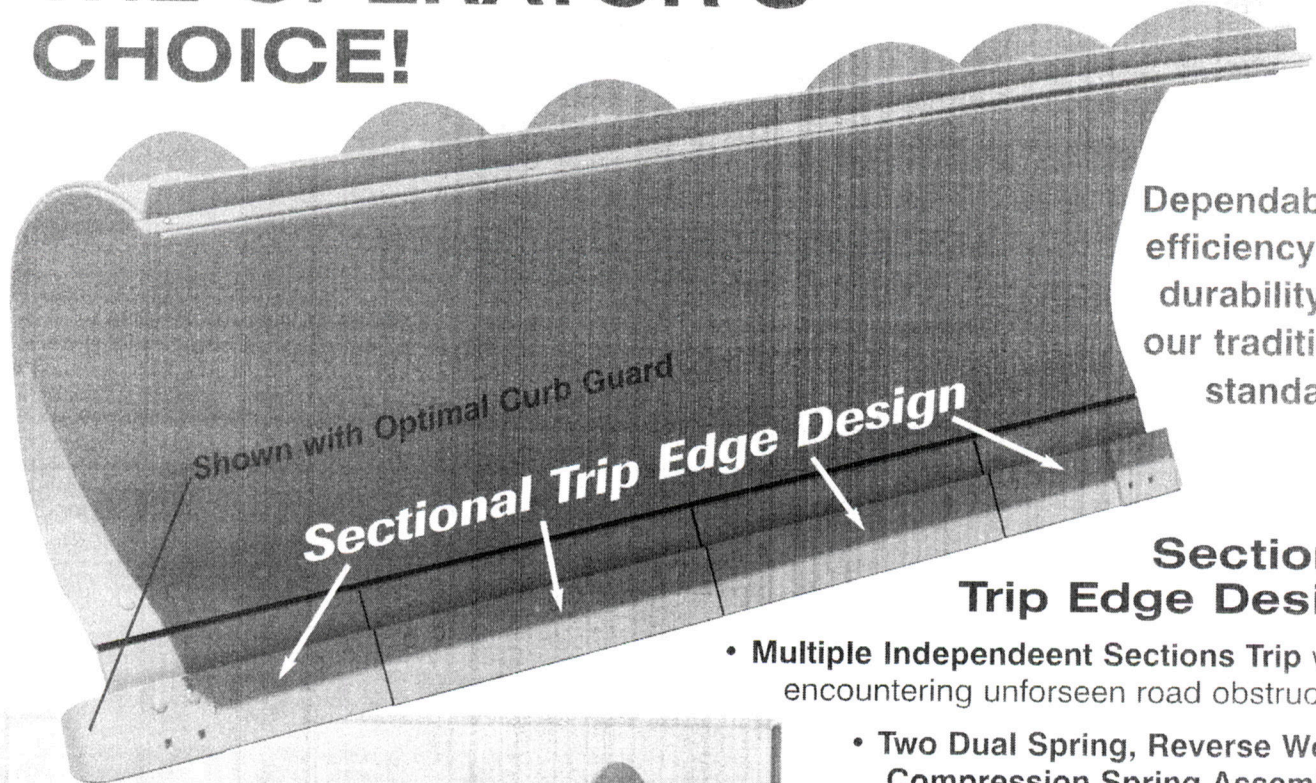

Dependability, efficiency and durability are our traditional standards.

Shown with Optimal Curb Guard
Sectional Trip Edge Design

Sectional Trip Edge Design

- Multiple Independent Sections Trip when encountering unforeseen road obstructions
- Two Dual Spring, Reverse Wound Compression Spring Assemblies per trip section
- Adjustable Tension Trip per section



Flared Moldboard Ends

- Increase discharge of snow from curb
- Helps prevent overriding of snow

Integral Shield

- Improves Operator Visibility
- Restrains Snow from Overriding
 - Aids discharge of snow to far end of moldboard

"TRIP CUTTING EDGE"
Originated and Patented by BAKER

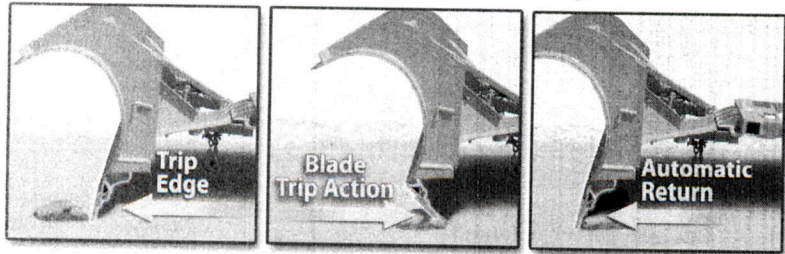

BAKER/FLINK TRIP EDGE SNOW PLOW

The Next Generation!

Manufactured by Flink Company • 502 N. Vermillion St. • Streator, IL 61364
A PROVEN LEADER IN ICE AND SNOW REMOVAL EQUIPMENT



BAKER/FLINK 500 REVERSIBLE PLOW

SPECIFICATIONS

MODEL NUMBER	PLOW HEIGHT	MOLDBOARD THICKNESS	MOLDBOARD LENGTH		SECTIONAL CUTTING EDGES		NO. OF VERTICAL RIBS	PATH CLEARED		APPROX SHIP WEIGHT
			AT BOTTOM	AT TOP	5/8" X 6" x 2' LONG	5/8" X 6" x 3' LONG		AT 28°	AT 35°	
2PR559S	36"	3/16"	10'0"	10'10"	2	2	8	8'10"	8'2"	1450
2PR559U	42"	3/16"	10'0"	10'10"	2	2	8	8'10"	8'2"	1475
2PR554U	42"	3/16"	11'0"	12'0"	4	1	8	9'8"	9'0"	1860

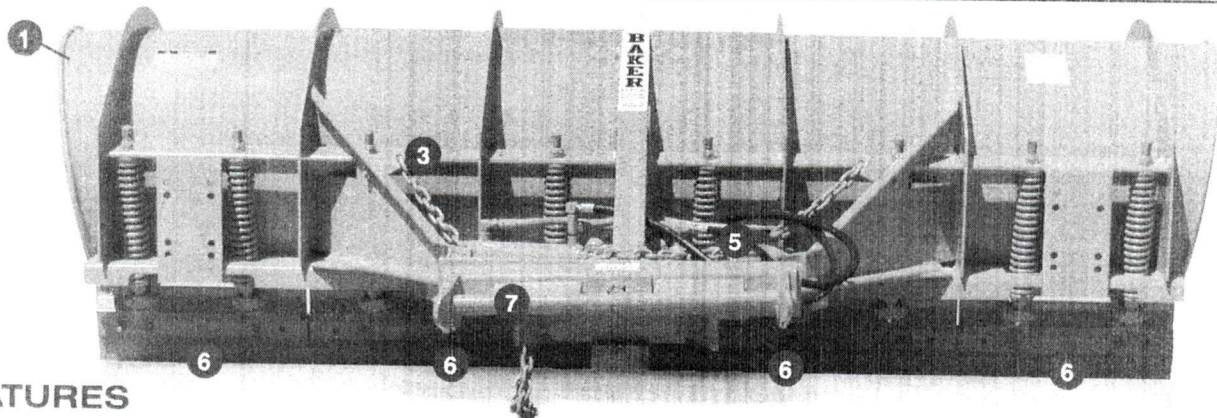

FEATURES

- ① Rugged 3/16" plate paneled steel moldboard with 1/4" gussets and main deck; all welded construction. Flared at the top to increase discharge efficiency.
- ② 3" x 2-1/2" x 3/8" angle for top edge reinforcement.
- ③ 3-1/2" x 3-1/2" x 1/2" mod-moldboard reinforcement and spring assembly support.
- ④ Heavy-duty, multi-position "A" frame allows reversing to desired angle.
- ⑤ Two double-acting power reverse cylinders.
- ⑥ Blade hinge weldments permit 3-14" wear from 6" cutting edge. Standardized in 2' and 3' lengths on reversibles.
- ⑦ Swivel bar allows plow to follow contour of road.

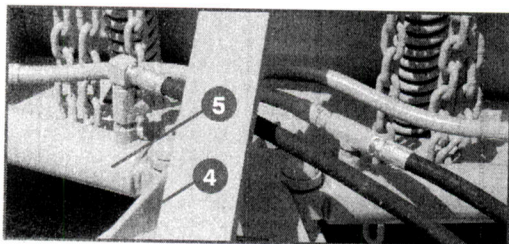

- ④ ⑤ Save time and labor with double-acting Ram Power Reverse! Power Reverse and heavy-duty "A" frame allows for infinite plow positioning from 0° to 35°.

OPTIONS:

- Caster Wheels (A)
- Wear Runners
- Pneumatic Tired Wheels
- Quick Link Swivel Bar (B)
- Tapered Rubber Deflectors
- Manual Angle
- Cutting Edge Shoes
- Jack Stand
- Universal Curb Guards (C)
- One-Piece Cutting Edge
- Cushion Valve

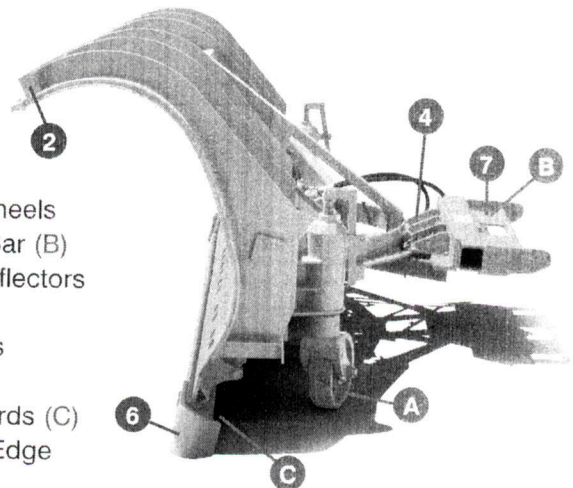

Manufactured by: **Flink Company**
 Phone: 815/673-4321 • Fax: 815/672-2678
 Email: flinkco@mchsi.com
 502 N. Vermillion St. • Streator, Ill 61364

Sales and Service By:

Specifications Subject to Change Without Notice



FDA PUSH FRAME SERIES HITCH

PIN CONNECTION
OR
QUICK LINK HITCH WITH FOLD DOWN ARM

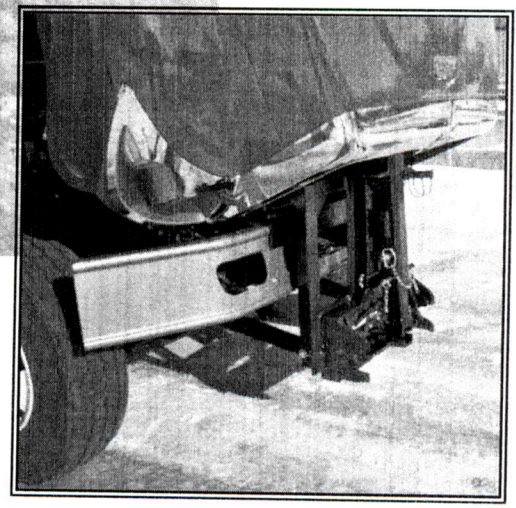
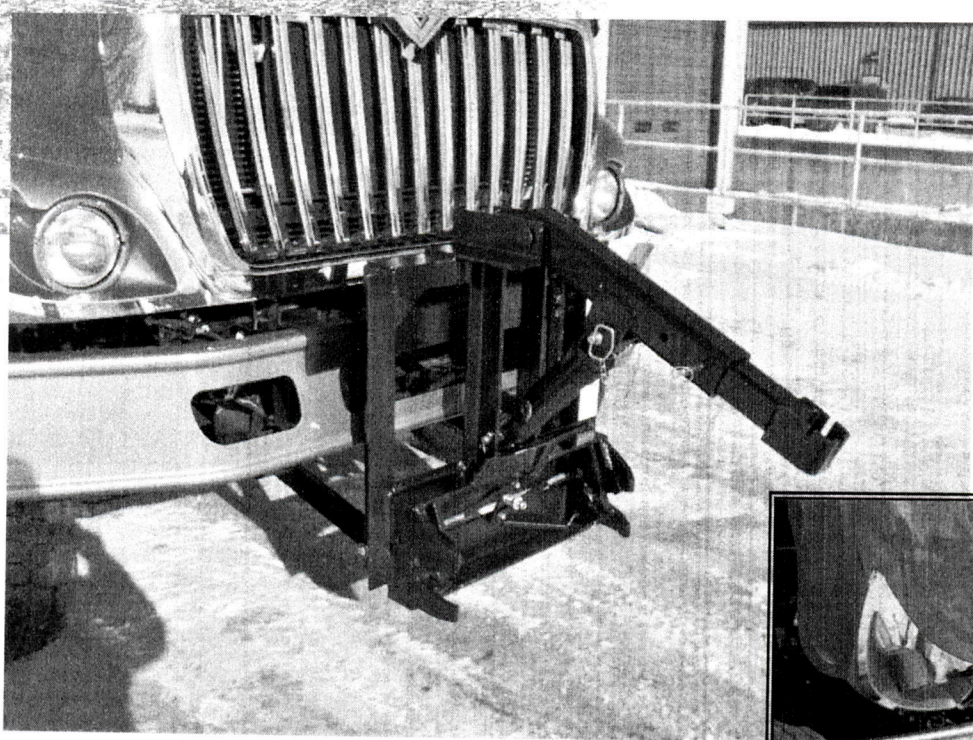

Shown with Quick Link Receiver,
standard is 30-1/2" center push point.



SPECIFICATIONS

GENERAL:

The New PF10FDA series bumper to frame hitch with a fold down lift arm feature was designed by FLINK for trucks with low profile - stationary grills. It offers the convenient pin type or the Quick Link connecting arrangement.

FEATURES INCLUDED:

- Low profile design with 8 adjustable mounting heights
- Special fold down arm allows the operator to manually tilt lift arm for storage with minimal effort when plow is unhooked or during off season
- Plow remains coupled to the push frame when hood is in the tilt position
- Level lift feature allows the plow, when raised, to rotate left or right without major list in either direction
- Telescoping lift are from 34" to 46"
- No tools required for easy removal of top section and canister for off season storing, cleaning or repair
- Quick installation with the strength, durability and reliability needed for long term performance
- Universal mounting for trucks rated at 19,500 GVW and up

OPTIONS AVAILABLE:

- Heavy Duty lift arm
- Single acting 3"X 10" cylinder
- Double acting 3"X 10" cylinder
- 21" and 23" center points on Pin Style
- Custom design for special applications
- Side Plate Mounting

www.flinkplows.com

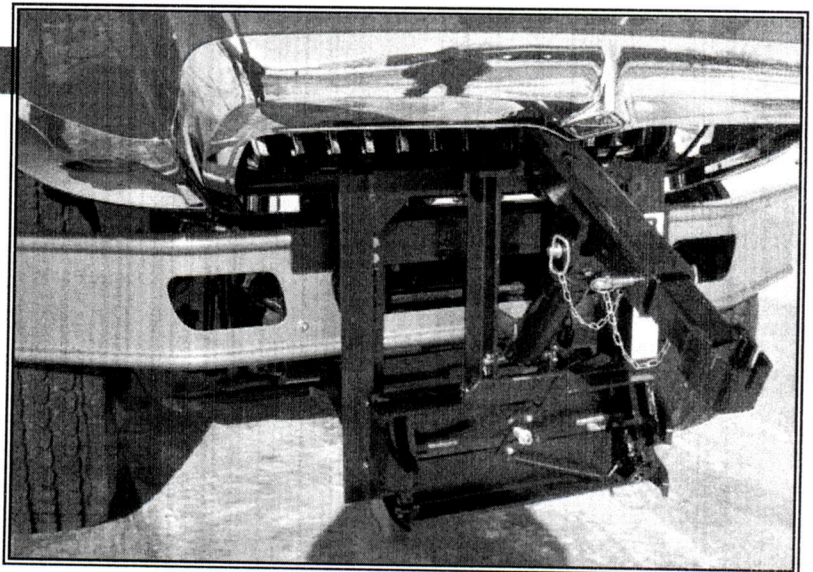

Manufactured by Flink Company
502 N. Vermillion St., Streator, IL 61364
Phone: (815) 673-4321 info@flinkplows.com